

UNCLASSIFIED

AD NUMBER
ADB807323
NEW LIMITATION CHANGE
TO Approved for public release, distribution unlimited
FROM Distribution authorized to DoD only; Administrative/Operational Use; JUN 1946. Other requests shall be referred to Air Materiel Command, Aero Medical Lab., Wright-Patterson AFB, OH 45433.
AUTHORITY
Air Force Aero Medical Lab ltr dtd 6 Jul 1971

THIS PAGE IS UNCLASSIFIED

St Milton Alexander

AAF Technical Report 5501

HUMAN BODY SIZE IN MILITARY AIRCRAFT AND PERSONAL EQUIPMENT

This document is supplied for use
and for the duration of a specific
circumstances warrant earlier re-
soon as it serves its purpose you w
our reproduction cost by returning it t

ARMED SERVICES TECHNICAL INFORMATION
DOCUMENT SERVICE CENTER
Knott Building, Dayton 2, Ohio

ARMY AIR FORCES
AIR MATERIEL COMMAND
Wright Field **Dayton, Ohio**

Unclassified
Best Available Copy

NOTE

When drawings, specifications, and other data prepared by the War Department are furnished to manufacturers and others for use in the manufacture or purchase of supplies, or for any other purpose, the Government assumes no responsibility nor obligation whatever; and the furnishing of said data by the War Department is not to be regarded by implication or otherwise, or in any manner licensing the holder, or conveying any rights or permission to manufacture, use, or sell any patented inventions that may in any way be related thereto.

The information furnished herewith is made available for study upon understanding that the Government's proprietary interests in and related thereto shall not be impaired. It is desired that the Patent & Royalties Section, Office of the Judge Advocate, Air Materiel Command, Wright Field, Dayton, Ohio, be promptly notified of any apparent conflict between the Government's proprietary interests and those of others.

Espionage Act

Notice: This document contains information affecting the national defense of the United States within the meaning of the Espionage Act (U. S. C. 50 32). The transmission of this document or the revelation of its contents in any manner to an unauthorized person is prohibited by law. (AR 380-5, paragraph 17 b.)

Report No. 5501

ADB807323

20061017013

Date 10 June 1946

WAR DEPARTMENT
ARMY AIR FORCES
AIR MATERIEL COMMAND
DAYTON, OHIO

ARMY AIR FORCES TECHNICAL REPORT

NO. 5501

HUMAN BODY SIZE IN MILITARY AIRCRAFT AND
PERSONAL EQUIPMENT

Title

BY

Francis E. Randall

FRANCIS E. RANDALL, CAPTAIN, AIR CORPS

Albert Damon

ALBERT DAMON, CAPTAIN, AIR CORPS

Robert S. Benton

ROBERT S. BENTON, CAPTAIN, AIR CORPS

Donald I. Patt

DONALD I. PATT, 1ST LT., AIR CORPS

Coordinated by

A. P. Gagge

A. P. GAGGE, LT. COLONEL, AIR CORPS

Approved:

Lloyd E. Sheffis

LOYD E. SHEFFIS, COLONEL, M. C.,
Laboratory Chief

For the Commanding General:

Content and classification authenticated by:

Carl Arnold
for Chief, Engineering Division

Laboratory No. TSEAA

E. O. No. 695-43

No. of Pages 333

No. of Photos 125

No. of Drawings None

Best Available Copy

TABLE OF CONTENTS

Chapter	Page
Summary.....	3
I Introduction.....	4
II The Functional Man.....	6
III Personal Equipment (Male)	
Introduction.....	11
Helmets.....	13
Goggles.....	26
Oxygen Masks.....	27
Coveralls.....	33
Two-piece Garments.....	34
Gloves.....	48
Footgear.....	54
Clothing, Female.....	65
Flak Clothing.....	74
Parachutes.....	76
IV Aircrew Positioning.....	78
Cockpits (Conventional).....	79
The Center of Gravity of the Seated Fighter Pilot....	116
Body Size Consideration for Ejection Seats.....	119
Prone Position.....	131
Bombardier-Navigator Seating.....	136
Anthropometry in the Design of Aircraft Gun Turrets..	137
Manikins.....	193
V Aircraft Clearances	
Emergency Exits.....	202
Catwalks.....	206
VI Crew Weights.....	208
VII Movement of the Head and Eye in Sighting.....	211
VIII Appendices	
1. Anthropometric Instruments.....	221
2. Head Dimensions.....	223
3. Male Body Dimensions.....	233
4. Female Body Dimensions.....	291
5. References.....	323
IX List of Photographs.....	328

SUMMARY

*

The functional aircraft must include its crew members. The flight potential of an aircraft can never exceed that of its crew members.

The present report deals with the relation of human body size to military aircraft and equipment. It contains the necessary data and instructional material to guide the designers of aircraft and associated flying equipment in the proper use of anthropometry, as it applies to AAF flying personnel. The functional man is fully described and the spatial requirements of his personal equipment are evaluated. Finally, the complete functional man is considered in his air crew position and as an integral part of the functional aircraft.

CHAPTER I

INTRODUCTION

From the time the Wright brothers constructed their first airplane and flew it in 1903, the problem of adapting aircraft design to all the high technical requirements has met with unlimited attention. The requirements established by air flow characteristics, by air speeds, altitudes, temperatures, as well as the other mechanical problems which must be considered, such as the size of instruments, the stress of metals and other materials, have occupied almost to the fullest extent the attention of designers. With all due credit to the highly developed techniques which have been, and continue to be, applied to aircraft design, it is the purpose of the data presented on the following pages to try to aid in some degree the consideration of the designers in so far as the problems presented by human body size are concerned.

The concept of writing specifications on the man which are as definite and demanding as any of those written on any type of material or equipment otherwise used in an airplane has been attempted many times. It is certainly realized by any sincere designer that his potential airplane is not really complete until a man actually enters the plane and engages it in flight. It should be quite apparent that the operational behaviour of an airplane of unlimited potentialities is actually no better than the behaviour characteristics imposed upon it by the physiological capabilities of the human being involved. It has been the experience of the Army Air Forces during the progress of World War II that many problems relating to inefficiencies on the part of the flight personnel could have been eliminated had the designers of the planes been fully cognizant of some of the implications of human biology.

The data discussed later in this report are not presented in an effort to try to sell engineers on the idea that an airplane should be considered only from the standpoint of the human being, but rather that it should be considered as a functional unit combining both the aircraft and the human being under flight conditions. Therefore, it shall be constantly stated that these data are actually specifications and should receive as much attention as do those specifications relating to any other type of equipment.

One of the most interesting historical facts which has been brought to our attention has been the one of the condition in which the original flights were made. It will be recalled that these occurred with the pilot flying in what is termed the "prone" position, and that our so-called conventional positions for the pilot now are actually the opposite, historically speaking. It would be interesting to speculate upon what progress aircraft would have made had the man been retained in his original prone status. Recent developments along this line, which are usually considered radical, are actually a continuation of studies which the Wright brothers initiated, and we shall gain much information from flight tests which will be conducted on this position. Aerodynamically it is

probably the best possible position in which the pilot can be installed in the aircraft because it permits the minimum thickness to be designed into the plane.

The first Army Air Forces attempt made to write a specification on the human being for use in aircraft was made about 1926, at which time Mr. Hugh Lippman constructed from meager data available a profile scale manikin which was used up to the time Captain (now Colonel) Harry G. Armstrong prepared data derived from Randolph Field Aviation Cadets in such a manner as to illustrate that the Medical Corps and Air Corps physical size requirements were permitting acceptance of unnecessarily large individuals. At that time 6'7" and 250 pounds were acceptable. It was Armstrong's recommendation that these maximum limits be dropped to 6'4" and 200 pounds, and that almost as large a population would be obtained inasmuch as only a very small per centage of individuals falls above that value. It was also Armstrong's recommendation that fighter pilot sizes should be limited to 70" and 180 pounds, in order to gain as much performance as possible from fighter aircraft. This recommendation was accepted with certain reservations. For some period the fighter stature was held at 5'8" instead of the 5'10" recommended by Armstrong. This acceptance limit was adequate so long as peacetime requirements remained. However, with the advent of stepped-up military requirements in 1942, such a large number of men was required for pilot training that a 5'8" limit actually prevented full use of the potentials available. The greatest defect which appeared in this regard was due to the fact that the fighter-type aircraft available for military use at that time had been designed around the 5'8" average and, without due regard to this fact, the limits were stepped up to 5'10" again, irrespective of the abilities of the planes to accommodate these higher statures.

This situation would not have been too disastrous had the original design requirements remained in use. That is to say, that these aircraft had been designed to fly not more than 3 and 1/2 hours. However, it is easily recognizable that this situation did not remain, inasmuch as long range requirements entered in and wing tanks and belly tanks were added to these same aircraft to enable them to fly as much as seven to eleven hours. There could be no modifications of the cockpit to provide any comfortable conditions for the pilots of the large stature who would be trained to fly these planes. This situation subsequently developed into probably the most difficult problem from the human operational standpoint encountered in World War II. The fact that high priorities were assigned by Army Air Force Headquarters to every aspect of problems relating to the alleviation of fatigue of pilots is alone sufficient proof of its importance. Therefore, from the standpoint of operational requirements of the Army Air Forces, every preliminary design should incorporate to the fullest extent the consideration of the size of human beings, and, also, that every consideration should be made in a cockpit design to provide for every eventuality possible regarding the possible ranges of this aircraft. It will, therefore, be the purpose of all the discussions to follow to try to instruct the designers in the best known way to provide adequate functional and comfort installations in cockpit designs in such a manner that the aircraft will not be limited in its performance by the poor functioning of the human beings involved.

CHAPTER II

THE FUNCTIONAL MAN

The concept of the functional man is of such a nature as to complicate the entire picture in the design of aircraft. Historically, the man has been regarded too frequently as a constant and a more or less static piece of equipment. This is probably the factor which has contributed more than anything else to the failures in operational aircraft so far as the performance of the human being is concerned. It will be well to keep in mind the general problems presented in this concept.

First, the "man" is not of a single size. See Figure II, 1. In fighter aircraft the stature is allowed to vary from 5'4" to at least 6', and in some cases actually exceeds this value. The weight may vary from 120 to 180 pounds. In bombardment type aircraft commissioned officers may vary from 5' to 6'4", and in weight from 120 to 200 pounds. Enlisted personnel may also vary in this degree. Inasmuch as the bombardment-type plane operationally may have to rely upon a high degree of interchangeability of personnel, it is advisable to design into every crew position adjustabilities which can accommodate this entire size range.

In addition, functionally speaking, this "man" may vary in the amounts of equipment worn, from very light clothing, including a small quick-attachable parachute, to the large bulky total of the equipment consisting of heavy flying clothing, emergency survival vests, life rafts, flak suits, and heavy parachutes. Figure II, 2. This total amount of equipment may in certain conditions add as much as 117 pounds of weight to the nude weight of the individual. (See Chapter VI). Therefore, in weights and balance calculations alone full consideration must be given to the extreme variabilities which may actually be encountered in operation of the aircraft.

Next, and of no less importance, is the factor involved in the space requirements of the aircrew as they go through the motions of performing their duties. Minimum dimensions will avail us nothing if they must be greatly exceeded in the operational requirements of the individual. Ideally, a man can pass upright through a cat-walk, but under design requirements the size of the plane is usually of such a nature as not to permit a very large per centage of individuals to stand upright in a cat-walk. Therefore, a great majority of the men must bend over to some degree and increase their cross-sectional dimensions considerably. Because of this, it will avail us little, if anything, to cut off the top of the cat-walk to fall within the allowable limits of the design and give no consideration to an increase in lateral dimensions.

In addition, there are known requirements based upon (a) the length of the leg, and (b) the amount of travel which it can obtain in the operation of the rudder pedals, which should be given primary consideration in the location of rudder pedals in relation to the feet. It will merely cause us trouble in the

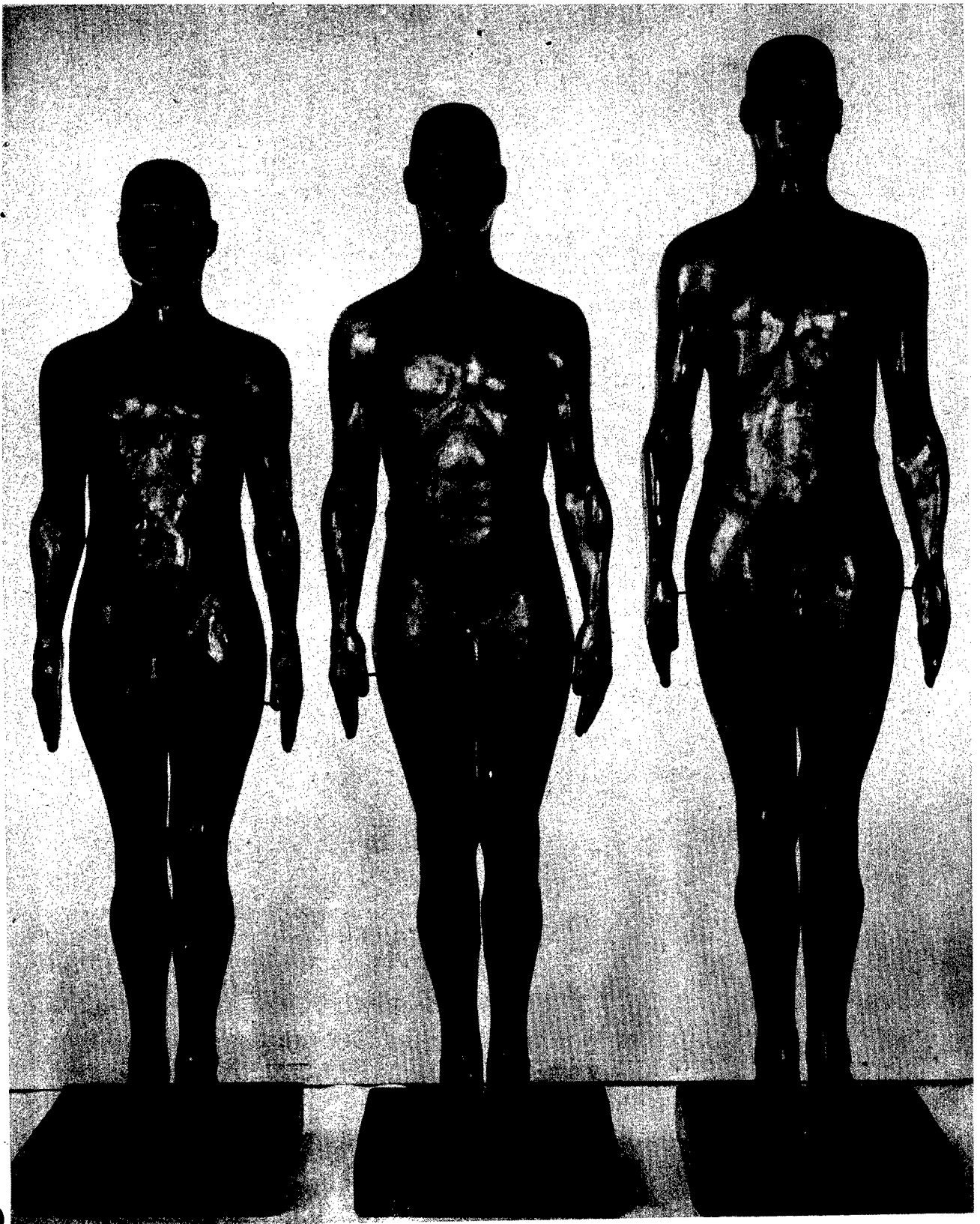

Figure 10, 1



Figure II, 2.

in the long run if we ignore this basic requirement and install rudder pedals at a distance determined by other considerations of the aircraft designer.

Finally, and this is one of the most important considerations that should be held constantly in mind by the designers, that from the standpoint of human efficiency, no airplane should ever be considered as a short-range aircraft so long as there is the remotest possibility that the addition of extra fuel tanks or the improvement of power plants will permit it to exceed the original design requirements. Because of this factor, every cockpit arrangement should utilize the full potentialities for providing the human being with efficiency and comfort measures. It has been a sad experience in the Air Forces that operational requirements have forced us to add extra fuel tanks to aircraft in order to obtain greater range from them after the aircraft have been produced and space limits have been such in the cockpit that the man has been forced to remain under short range spatial conditions whereas the aircraft itself has been permitted to engage in long range operations.

Combat reports unanimously support this statement and are sufficiently strong in nature to warrant constant attention to this point. The outstanding examples to date have been encountered in fighter type aircraft. However, there are strong indications that the problems will become increasingly great in bombardment type planes if adequate consideration is not given. The tail gun position, for example, in the B-29 proved this point. The amount of production and modification time required to achieve comfort and efficiency under operational conditions in aircraft which have not originally had these requirements designed into them is enormous and ultimately cost more time than would originally have been required in modification of the mock-up or the very early production models. Over a given period, more aircraft of a type will be available operationally if some time is invested in the early stages in order to achieve this purpose.

In addition to the engineering requirements which are imposed by the human being and which can be adequately met if early consideration is given to them, there is a strong indication that the actual work of the flight surgeons and the Medical Corps in general would be reduced considerably if the man received a greater amount of attention.

Let us begin then with the nude man in the more or less static sense of the word and develop him throughout the whole range of requirements which have been established for his use in aircraft. First, the use of the functional man as such. This is the man sent to the aircraft for installation from a training center. He already has certain inherent characteristics in him which can in no way whatsoever be modified. He is of a size which may vary, as noted earlier, and he may have certain potentialities so far as useful time is concerned upon which actual specifications can and have been written. He must be taken as he stands upon "delivery" and installed effectively in an airplane. It is the responsibility of the designer and the manufacturer to have provided tolerances in the plane in order to insure efficient installation of the equipment.

We can well imagine the difficulties which are encountered in some sub-assemblies when one item has been delivered with certain fixtures which are over-sized compared to their original requirements. It takes little time in the ordinary processes to see that this matter is corrected, yet it has been common procedure to ignore equally glaring inadequacies and tolerances in conditions involving the man. First, let us begin with the sub-assembly of the piece of equipment which will be installed in the airplane. As was stated above, this sub-assembly will consist of the nude man clothed with a great variety of the equipment and his ultimate efficient size will be determined by the degree to which adequate consideration has been given to the design of the personal equipment on him and the location of certain accessory items which are appended to him. For example, to take an absurd case, it would be very inadvisable to locate all the parachute in a square bundle on the man's back, and in addition to locate all the emergency equipment in another square bundle on his chest because this would limit one of the most important dimensions involved in aircraft. Absurd as the example is, it has actually been encountered in some degree. Therefore, the first section of this report will be directed to instructions to the designers of personal equipment in techniques by which they can obtain minimum size and, eventually, maximum efficiency of aircrew personnel.

CHAPTER III

PERSONAL EQUIPMENT

Introduction

Efficient operation of aircraft by Army Air Force flyers is not alone the concern of the aircraft designer and engineer. The use of cramped spaces such as gun turrets, catwalks, etc., involves quite as much the design and sizing of the personal equipment which a crewman must wear to obtain insulation from a hostile environment. Clothing that is needlessly bulky and ill-fitting can make restricted quarters, which would otherwise be adequate, a straight jacket for the man expected to use them. Likewise, the lack of properly fitting clothing leads to the wearing of non-standard and make-shift assemblies which may endanger the crew members' lives through the lack of familiarity with their use and functional dependability.

At the out-break of World War II, the Army Air Forces had no responsibility in the development and procurement of flying clothing, per se. However, it was realized at an early stage that such responsibility should be duly assigned to the matériel agencies. Accordingly, an organization was established to accomplish this mission, but, since little experience was available upon which to base procurement, sizing of flying clothing was left to the individual manufacturer, who was reputed to grade sizes of his products according to standards known as "commercial practice". Since most such manufacturers had experience in the production of civilian clothing for a considerable period of time, it was assumed that standards of "commercial practice" would also be sufficient standardization for flying clothing.

Of the items of personal equipment for which the Army Air Forces were responsible, the standard equipment consisted of the A-9 and B-6 helmets, the B-7 goggles, and the A-8 oxygen mask. These items were products of individual agencies responsible for the development of such items. The uses and needs for these items were diverse enough to warrant more or less restricted development on each individual item, and admittedly very little was known about heads of Army Air Force personnel who would use this equipment, as well as about the operational conditions which would determine what was needed.

The only check on whether clothing was actually fitting those for whom it was designed was by means of the stock inventory. This indicated, in a general way, what sizes of garments were being used up most rapidly, but due to the common practice of substituting when the proper size was not available, it could not constitute a very accurate check. However, even from these records it was indicated that sizing was inadequate. In many cases the range of sizes was obviously much greater than the demand, and complementary to this, certain other sizes were chronically low in stock or not available. Moreover, work on measurement of subjects clothed in various outfits indicated that flying clothing was

bulky and that improper sizing contributed in large measure to this condition.

Thus, one of the major problems was that of size control. If it could be solved, a long step forward would be taken, particularly toward:

- a) Adequately fitted men in the greatest possible number.
- b) Simplification of problems of procurement and supply by anticipation of requirements based upon a definite knowledge of size coverage.

Nude anthropometric measurements, already available, were useful; but only to a limited extent since allowance must be made for clothing in calculating size coverage and some measurements must be interpolated by use of formulae to obtain required values. Accordingly, as a first step, tailors' dimensions were taken on a large series of fighter pilots and medium, heavy, and very heavy bombardment crewmen. From the data thus obtained, distribution tables were made which give not only the ranges of critical dimensions but also the relative frequencies of occurrence of each measurement. These tables became the basis for judging the adequacy of size coverage as well as the compilation of predicted procurement schedulings for new types of clothing.

The following procedure was developed for control of size in flying clothing:

- a) Design was made, patterns cut and samples of each size of the garment contemplated for standardization were made up under the direction of the procuring agency.
- b) These sample garments were then size-tested on individuals known to represent the body sizes of Army Air Force flyers.
- c) If the samples proved to cover their respective size ranges adequately, two further steps were taken:
 - 1) Standardization patterns were copied from the master patterns and one set was supplied to each manufacturer of that type of clothing.
 - 2) A tentative procurement scheduling was drawn up from the distribution tables based upon known size coverage of each size of the garment.
- d) During production, manufacturers were required to submit at prescribed intervals items from their production runs, chosen at random by the Army Air Forces' resident inspector. These items were subjected to measurement check and comparison with the standards of known size function.

Thus a knowledge of the range of dimensions within the population to be fitted came into use. It required the addition of one smaller size in most types of clothing, but also made possible the elimination of from two to four larger sizes.

This general method was applied to each item of flying clothing. Of course, modifications and changes of techniques were made incident to the particular problems presented by different types of equipment.

The same general procedure was also utilized on all head equipment. However,

there was one important difference in this respect. Integration of the equipment is extremely important. Accordingly, seven head types were developed to aid in the joint problem of sizing and integrating the various items. During the period of 1942 through 1944, following the development of the head types, this project was carried on in conjunction with the agencies already responsible for the equipment, and as of January, 1945, there was a complete new set of equipment in operational use, consisting of the A-11 type helmet which incorporated earphone sockets to hold the earphones, the B-8 goggle, and the A-14 demand type oxygen mask. All of these separate units, when worn properly by an individual, added up into a fairly well integrated unit in such a manner as to cover the face completely. See Figure III, 1. This development has succeeded rather well in combating certain operational situations which gave rise to extreme frostbite on faces which were not adequately covered. Figure III, 2 shows the same application of this procedure to the pressure-demand type of oxygen and head equipment.

HELMET SIZING

The first procurement of flying helmets by the Army Air Forces in World War II consisted of two types: the A-9 summer flying helmet (wool gabardine); and the B-6 winter flying helmet (shearling). These helmets were made according to specifications, samples were submitted for approval, and manufacturers were required to do their own grading to produce the four sizes; small, medium, large, and extra-large, deemed necessary to cover the range of head size. At the time no actual information on the range or distribution of head size of Army Air Force flyers was available.

In a relatively short time it became apparent that the sizing of these helmets was not adequate. Stocks of extra-large and large helmets were chronically low, and American flyers were using foreign helmets wherever and however they could be obtained. The reason for this was amply confirmed by a series of forty each A-9 and B-6 helmets submitted for study of possible modification for earphone receptacles. Of ten helmets labelled extra-large, none could be found that fitted the larger heads. Only three large helmets could be found in the ten so labelled. The majority of the helmets fitted small heads. Evidently the manufacturers in using their own size grading systems were constructing helmets too small to perform their function.

Thus, when plans were laid for the construction of new types of helmets, the problem presented was two-fold:

- a) Determination of the range of head size of Army Air Force flyers and the distribution of sizes in various groups.
- b) So adjusting helmet sizes as to cover the range of head sizes and controlling this adjustment in manufacture to insure proper fit.

At the time there was available a large series of head circumferences calculated from measurements taken upon the Cadet-Gunner anthropometric series.

Engineering Division
W. O. 300-40-040-58
1 March 1954



1388400

Appendix 3
(Exhibit 5)

- 3 -

Figure III. 1

1590

Engineering Division
M.R. ENG-49-660-53
1 March 1944



1670-29-44

Appendix 3
(Exhibit M)

- 17 -

Figure III, 2.

138394

The range of head sizes derived therefrom (510 mm. to 620 mm.) could conveniently be divided into four sections. These were: small, 510 mm. to 540 mm.; medium, 541 mm. to 565 mm.; large, 566 mm. to 590 mm.; extra-large, 591 mm. to 620 mm. (Figure III, 3.) This gave each helmet approximately the same amount of work to do, with the exception of the very small and very large extremes, which amount to only a very small per centage of the entire group.

When designs had been drawn up and approved, manufacturers were required, in the first instance, to submit helmets graded as they considered necessary. These helmets were fitted on heads of known size corresponding in general to the range of head sizes of Army Air Force flyers, and an analysis was then made to determine whether each size of the helmet was adequately covering the desired portion of the range. In every case several sets of helmets had to be manufactured before it became apparent that this was what was being accomplished.

Once the sizes were established by fitting trials, measurements of certain dimensions of the helmets became standards by which future production of that type and size of helmet could be judged without resort to the prolonged methods of fitting in every case. These standard dimensions and a diagram illustrating how the measurements are taken were printed and distributed for the use of the Army Air Forces' resident inspectors in determining whether proper sizes were being adhered to. Figures III, 4; III, 5; III, 6; III, 7. As a further check upon proper sizing, once established, manufacturers were required to submit one of each size of helmet of a given number of helmets of each size produced for measurement and examination by the procuring agency. In this way, it was possible to take immediate steps to correct faulty manufacturing practice as it affected size.

To fulfill the need for some type of size standards, to facilitate inspection by check measurements, and to provide references for future work in head-gear sizing, selection of dimensions for the construction of a set of standard head forms was undertaken. Head circumference was used as the basic measurement and was divided into the four ranges outlined above. In the case of all head measurements, an attempt was made to draw values which represent average occurrences in the four ranges. Figures III, 8; III, 9; III, 10. Critical dimensions such as head length, breadth, height, etc., were held to tolerances of plus or minus one millimeter. The orientation values defining eye position, ear width, etc., were somewhat less rigidly controlled.

With the determination of proper size for helmets and establishment of methods of inspection, it was possible to provide a prediction for overall procurement. This was done on the basis of the Cadet-Gunner series with a result of 10% small, 40% medium, 40% large, and 10% extra-large, for procurement to cover all groups of flying personnel in the Army Air Forces exclusive of Womens' Army Service Pilots and Flying Nurses.

Further surveys were also made of specialized groups such as fighter and photo-reconnaissance, heavy bombardment, etc. These groups were found to vary

DISTRIBUTION OF HEAD CIRCUMFERENCES FOR HEAD SIZES

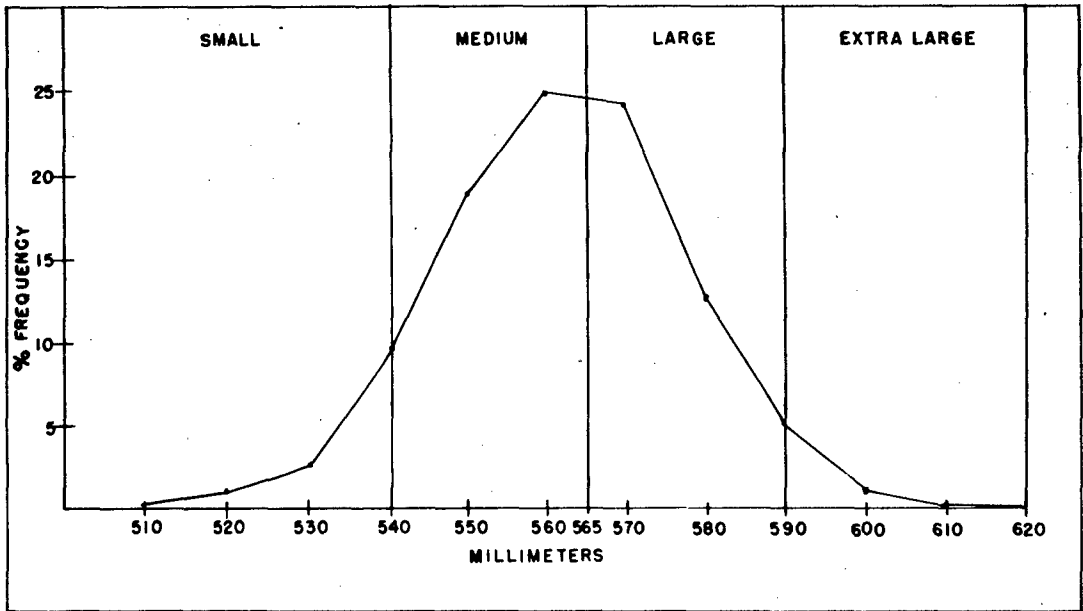

4375T AML

Figure III, 3.

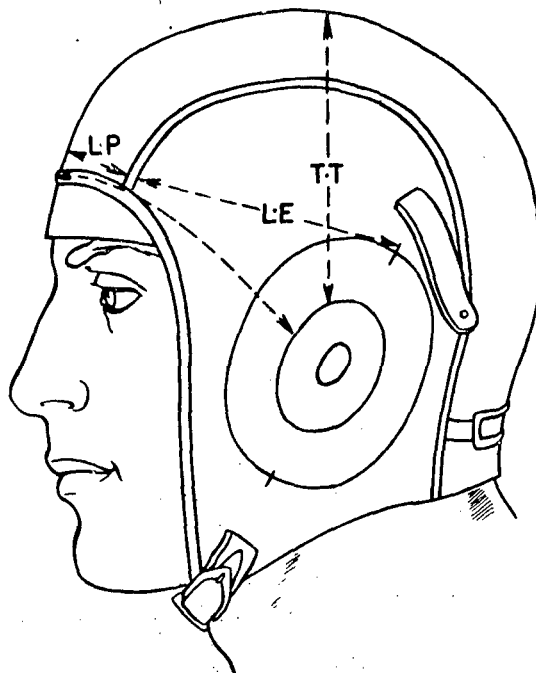
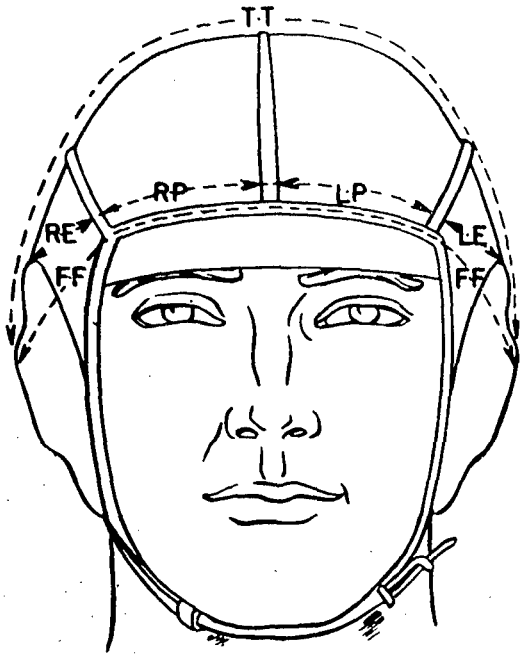

MEASUREMENTS TO BE TAKEN:

- F-F Across forehead stripping from edge of earphone socket to edge of other.
- T-T Vertically over top of helmet from edge of one earphone socket to edge of other.
- R-P Width of right top panel. Measure from center of right seam to center of middle seam where panel joins forehead stripping.
- L-P Same as for R-P.
- R-E Straight line from center of right panel seam where it joins forehead stripping to top mark of right earphone assembly.
- L-E Same as for R-E. (Measurements tell if earphone mountings are installed at proper angle.)

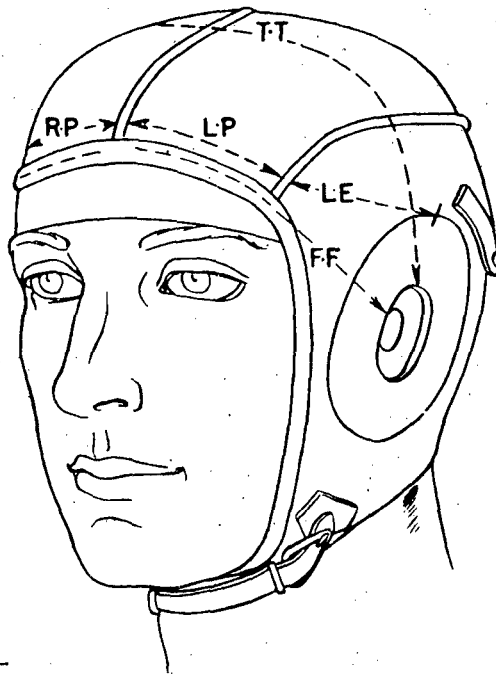

4420B AML

Figure 1, 4.

TYPE AN-H-16 HELMET

DESIRED DIMENSIONS AND ACCEPTABLE RANGES OF VARIATION

One Eighth (1/8)
Inch Pile Shearling

DESIRED
DIMENSIONS

ACCEPTABLE RANGE
OF VARIATION

		Inches		mm	
		Inches		mm	
Small	F-F	12-8/32	311	12-2/32 - 12-14/32	306-316
	T-T	13-12/32	340	13-6/32 - 13-9/32	335-345
	R-P & L-P	1-29/32	48	1-26/32 - 1-31/32	46- 50
	R-E & L-E	4-17/32	115	4-11/32 - 4-17/32	110-115
Medium	F-F	12-22/32	322	12-15/32 - 12-28/32	317-327
	T-T	13-21/32	347	13-15/32 - 13-27/32	342-352
	R-P & L-P	2-3/32	53	2-1/32 - 2-6/32	51- 55
	R-E & L-E	4-17/32	115	4-11/32 - 4-17/32	110-115
Large	F-F	13-3/32	322	12-28/32 - 13-8/32	327-337
	T-T	13-21/32	355	13-25/32 - 14-6/32	350-360
	R-P & L-P	2-8/32	57	2-6/32 - 2-11/32	55- 59
	R-E & L-E	4-17/32	115	4-11/32 - 4-17/32	110-115
Extra-Large	F-F	13-17/32	343	13-10/32 - 13-23/32	338-348
	T-T	14-12/32	365	14-6/32 - 14-19/32	360-370
	R-P & L-P	2-15/32	62	2-12/32 - 2-17/32	60- 64
	R-E & L-E	4-17/32	115	4-11/32 - 4-17/32	110-115

One Quarter (1/4)
Inch Pile Shearling

Small	F-F	12-15/32	317	12-9/32 - 12-22/32	312-322
	T-T	13-20/32	346	13-14/32 - 13-26/32	341-351
	R-P & L-P	1-31/32	50	1-29/32 - 2-2/32	48- 52
	R-E & L-E	4-17/32	115	4-11/32 - 4-17/32	110-115
Medium	F-F	13-5/32	334	12-31/32 - 13-11/32	329-339
	T-T	14-1/32	356	13-26/32 - 14-7/32	351-361
	R-P & L-P	2-6/32	55	2-3/32 - 2-8/32	53- 57
	R-E & L-E	4-17/32	115	4-11/32 - 4-17/32	110-115
Large	F-F	13-11/32	339	13-5/32 - 13-18/32	334-344
	T-T	14-11/32	364	14-5/32 - 14-17/32	359-369
	R-P & L-P	2-11/32	59	2-8/32 - 2-15/32	57- 61
	R-E & L-E	4-17/32	115	4-11/32 - 4-17/32	110-115
Extra-Large	F-F	13-19/32	345	13-13/32 - 13-26/32	340-350
	T-T	14-19/32	370	14-12/32 - 14-25/32	365-375
	R-P & L-P	2-17/32	64	2-15/32 - 2-20/32	62- 66
	R-E & L-E	4-17/32	115	4-11/32 - 4-17/32	110-115

Figure 111, 5.

TYPE A-11 HELMET

TYPE A-11 HELMET

Desired dimensions and acceptable ranges of variation

		DESIRED DIMENSION		ACCEPTABLE RANGE OF VARIATION	
		Inches	mm	Inches	mm
Small	F-F	12	306	11-27/32—12-7/32	301—311
	T-T	13-8/32	337	13-1/32 —13-14/32	332—342
	R-P & L-P	1-30/32	49	1-27/32— 2	47— 51
	R-E & L-E	Should not be permitted to exceed 115 mm., 4-17/32"			
Medium	F-F	12-18/32	320	12-12/32—12-25/32	315—325
	T-T	13-17/32	345	13-12/32—13-24/32	340—350
	R-P & L-P	2-5/32	55	2-3/32 — 2-8/32	53— 57
	R-E & L-E	Should not be permitted to exceed 115 mm., 4-17/32"			
Large	F-F	12-31/32	330	12-25/32—13-5/32	325 — 335
	T-T	13-29/32	354	13-23/32—14-3/32	349—359
	R-P & L-P	2-11/32	59	2-8/32 — 2-14/32	57— 62
	R-E & L-E	Should not be permitted to exceed 115 mm., 4-17/32"			
Extra-large	F-F	13-22/32	348	13-15/32—13-28/32	343—353
	T-T	14-10/32	364	14-3/32 —14-16/32	359—369
	R-P & L-P	2-17/32	64	2-13/32— 2-19/32	61— 66
	R-E & L-E	Should not be permitted to exceed 115 mm., 4-17/32"			

Figure III, 6.

TYPE AN-H-15 HELMET

TYPE AN-H-15 HELMET

Desired dimensions and acceptable ranges of variation

		DESIRED DIMENSION		ACCEPTABLE RANGE OF VARIATION	
		Inches	mm	Inches	mm
Small	F-F	11-23/32	298	11-17/32—11-29/32	293—303
	T-T	13	330	12-25/32—13-6/32	325—335
	R-P & L-P	1-14/32	37	1-12/32— 1-17/32	35— 39
	R-E & L-E	Should not exceed 4-17/32 in., 115 mm.			
Medium	F-F	12-14/32	316	12-7/32 —12-20/32	311—321
	T-T	13-12/32	340	13-6/32 —13-18/32	335—345
	R-P & L-P	1-23/32	44	1-21/32— 1-31/32	42— 46
	R-E & L-E	Should not exceed 4-17/32 in., 115 mm.			
Large	F-F	12-24/32	324	12-20/32—12-30/32	321—329
	T-T	13-25/32	350	13-18/32—13-31/32	345—355
	R-P & L-P	1-28/32	48	1-26/32— 1-31/32	46— 50
	R-E & L-E	Should not exceed 4-17/32 in., 115 mm.			
Extra-large	F-F	13-8/32	337	13-2/32 —13-15/32	332—342
	T-T	14-5/32	360	13-31/32—14-11/32	355—365
	R-P & L-P	2-4/32	54	2-1/32 — 2-6/32	52— 56
	R-E & L-E	Should not exceed 4-17/32 in., 115 mm.			

Figure III, 7.

DIMENSIONS OF AML HEAD SIZE STANDARDS

Dimension	SMALL		MEDIUM		LARGE		X-LARGE	
	Calculated	Actual	Calculated	Actual	Calculated	Actual	Calculated	Actual
Head Length	184	184	193	194	201	201	210	210
Head Breadth	143	143	149	150	156	156	162	161
Head Height	125	126	129	130	133	132	138	138
Head Circumference	533	533	556	557	579	578	600	599
Minimum Frontal	98	99	104	104	108	109	112	113
Ear Implantation	45	--	50	--	55	--	60	--
Ear Maximum	55	57	61	62	67	71	73	72
Face Length	112	112	120	120	128	127	136	138 1/2
Tragion-Otobasion Inf.	27	28	30	33	35	36	39	38
Horizontal-Nasion	90	90	100	102	110	112	120	117
Horizontal-Canthus	100	104	110	112	117	120	125	124
Wall-Canthus	158	157	167	165	176	174	182	183
Wall-Otobasion Inf.	95	97	100	102	110	110	115	113
Wall-Menton	179	183	187	186	196	198	204	213
Wall-Tragion	80	89	90	93	100	100	105	109
Neck Depth	108	114	115	123	124	126	133	140
Neck Breadth	110	113	117	120	126	129	135	136
Chin-Neck Projection	35	38	42	45	52	53	60	61

N.

Figure III, c.

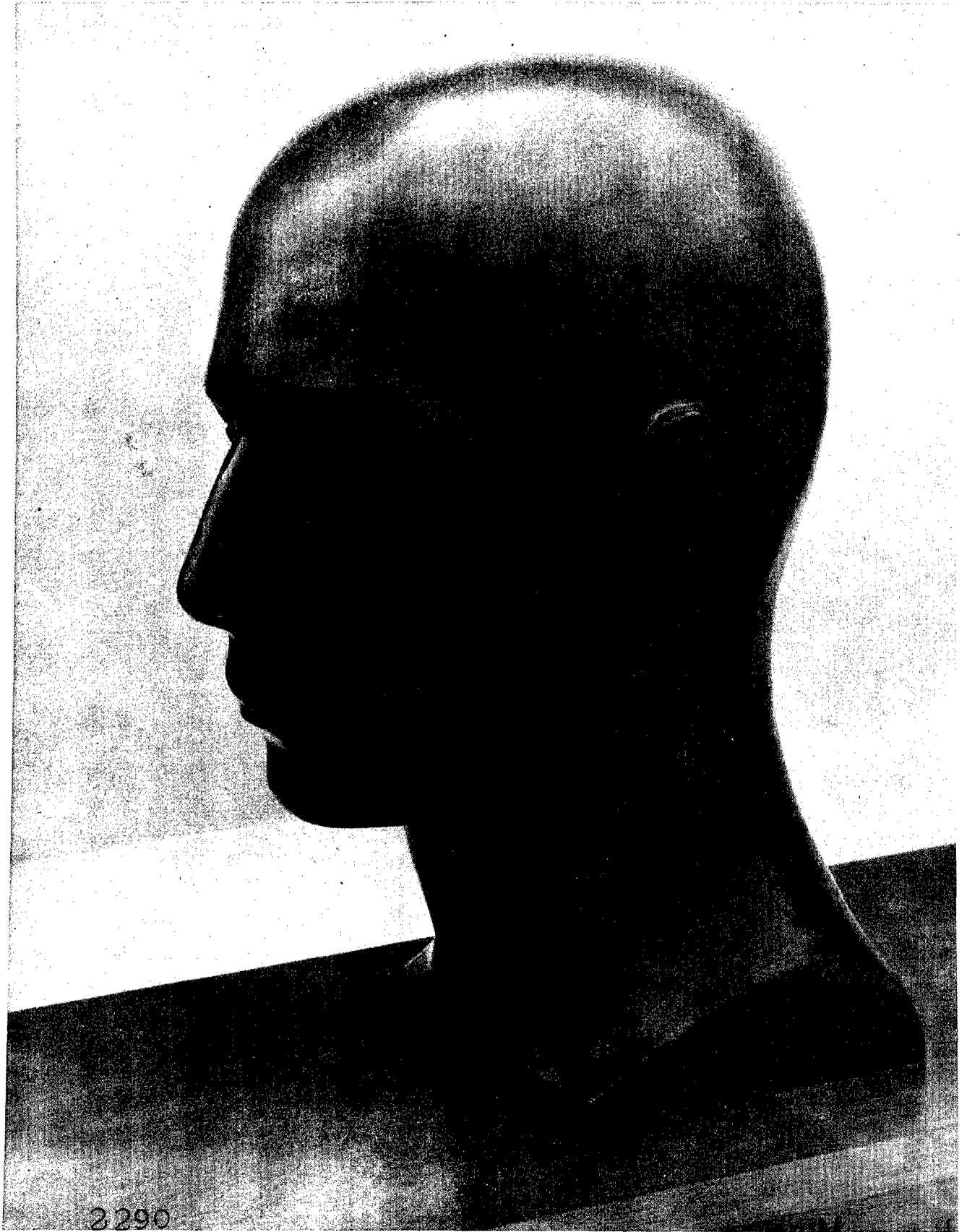

2290

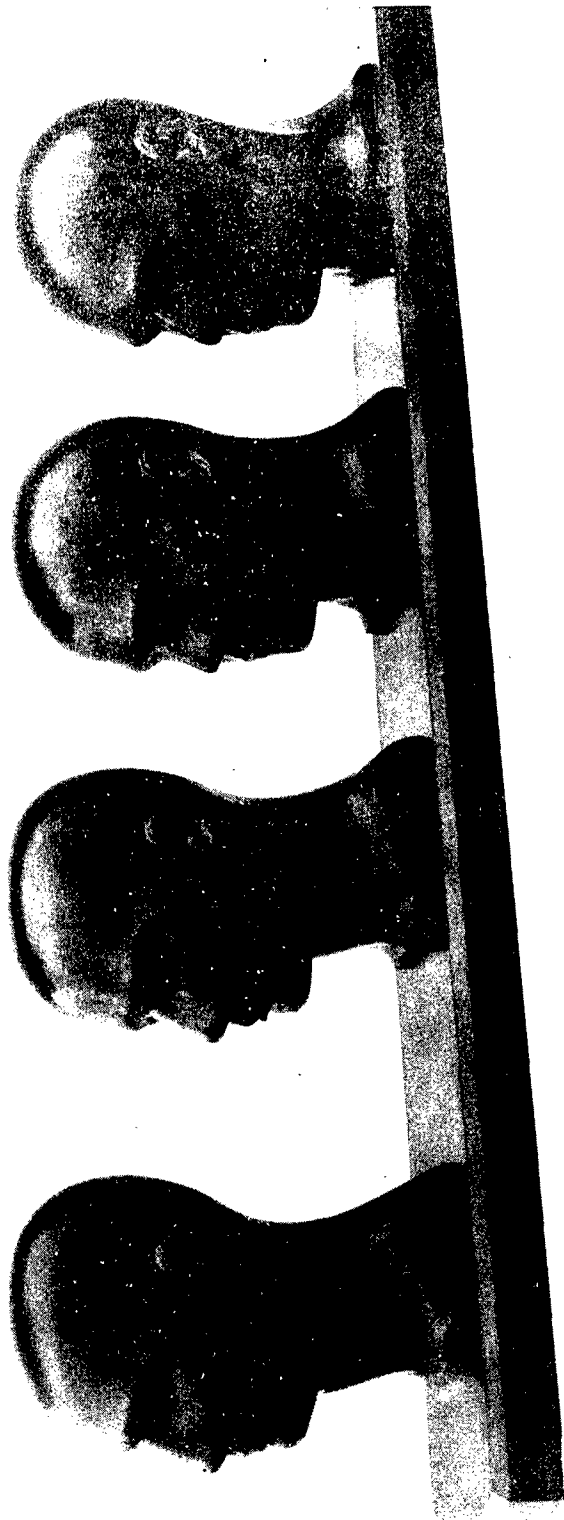

2288

Figure III, 10.

considerably in their requirements for various sizes of helmets, but when pooled, presented totals that to all practical purposes were the 10-40-40-10 ratio initially predicted.

DISTRIBUTION OF HEAD CIRCUMFERENCES
for
HELMET SIZES

Circumference	Aviation Cadets	Fighter & Photo-Recon. Pilots	Total Bombardment Aircrew	Total Very Heavy Bombardment Aircrew	WASP	Flying Nurses
510-540 mm. (Small)	8.66	1.34	10.94	9.98	1.25	45.76
541-565 mm. (Medium)	43.93	23.76	41.44	39.67	30.18	45.77
566-590 mm. (Large)	40.00	54.70	38.86	40.44	61.00	8.44
591-620 mm. (Extra Large)	7.41	20.18	8.74	9.88	7.54	0.00

Change in the relative proportion of types of aircraft operating at any given time, of course, would change the picture of overall procurement. For example, note the shift in percentages of helmet sizes required for Very Heavy Bombardment at different fields.

Size	Salina	Great Bend	Pratt	Total
Small	14.6	11.2	13.0	12.8
Medium	32.4	40.3	38.0	37.5
Large	34.6	41.6	31.1	37.6
Extra Large	18.5	6.8	16.8	12.7

This distribution illustrates how issue size percentages vary from issue point to issue point among aircrew manning a particular type of aircraft and how total percentages for one type may vary from the picture for overall procurement.

The problem of earphone receptacles in the helmet and their proper placing has also been investigated and the basic data regarding the location, size, and angulation of the ears necessary for any further study along this line are presented in the following table.

MEANS AND RANGES OF MEASUREMENTS
FOR
DESIGN OF EARPHONE MOUNTINGS

	Mean (mm)	Range
Supra-auricular (head breadth just above ears.)	152.44	139-164
Bi-zygomatic (face breadth just in front of ears.)	140.90	134-152
Bigonial (jaw breadth just below and in front of ears.)	114.30	101-126
Minimum (breadth just below ears.)	122.10	102-143
Bi-mastoid (breadth over mastoids.)	136.50	118-148
Ear height (maximum length of ear.)	66.70	57-80
Ear breadth	36.90	30-45
Ear angle (angle of ear projection from plane lying against zygomatic bones and the mastoid process.)	29.80°	17-39°

GOGGLES

The anthropometric aspects of the goggle problem are relatively simple. The most important dimension relating to the face is the bi-ocular, or breadth between the outside corners of the eyes. The goggle can be no smaller than the largest encountered, 103 mm., and should be no larger than this, because a high degree of unnecessary cramping between the goggle and the helmet will occur.

The other aspect of the problem, which must follow the first, is that of obtaining proper size integration between the goggles, helmet, and the oxygen mask. Figures III, 1 and III, 2 illustrate how this was attained during the work conducted in World War II.

A further discussion of the integration between the goggle and the mask will be found in the following section.

OXYGEN MASKS

To the casual observer, the human face, collectively speaking, is a conglomeration of greatly variable features which amalgamate themselves into a set of topographic mounds and depressions which remain in our memory as the "face". Because of the extreme complexity and variability of these features, there has been little effort made until recently to define the total in a metric manner so that objective approaches can be used in the development of items of equipment which come in contact with the face. The basic problem of the project first carried on in the Aero Medical Laboratory was to attain such an objective. Consequently, a basic series of 1454 Air Force personnel was measured, and, subsequently, about 1500 were added to this series for check purposes. The final working data were resolved into seven head and face types which are shown in Figure III, 11.

So far as the use of an oxygen mask is concerned, there are certain basic patterns which are quite constant regardless of the superficial aspects of the mask. These are due to the fundamental structural anatomy of the human face. Dimensions taken laterally on the face are most commonly on soft tissues, which are subject to a considerable degree of compressibility. Measurements taken vertically on the face encounter bony or cartilaginous structures, which are quite definite in their position. An oxygen mask must, therefore, either be made in sufficient sizes to accommodate the bony projections or shall be sufficiently pliable to do so. The great problem is to determine the proper compromise.

Inasmuch as the vertical dimension of the face from the root of the nose to the base of the chin is what might correspond to the length of the hand in gloves and the length of the foot in shoes, it has been taken as a primary reference line in all the development and assessment of oxygen masks. It will vary in the white male from 101 to 146 mm.; in the negro from 112 to 152 mm.; and in the white female from 96 to 136 mm. Figure III, 12 shows how sub-groups of the male white and female white populations will be distributed on face lengths. Therefore, in order to obtain the small number of sizes which can be efficiently used, these basic length dimensions must be considered.

Considering first this variation in length of face, which in the white male is about $1\frac{7}{8}$ inches, we can work with a possible total fit variation of only about $\frac{1}{2}$ inch of nasal bone on any one individual. Having only this $\frac{1}{2}$ inch available as an anatomical tolerance permitted us by nature, it is then our problem to determine first the pliability of a single oxygen mask in attaining the maximum degree of behaviour within the total range of $1\frac{7}{8}$ inches. If pliability is small, the mask must ride up and down on $\frac{1}{2}$ inch of nasal bone, and assuming this pliability to remain constant in any size of mask, it would require four sizes to cover adequately the $1\frac{7}{8}$ inches.

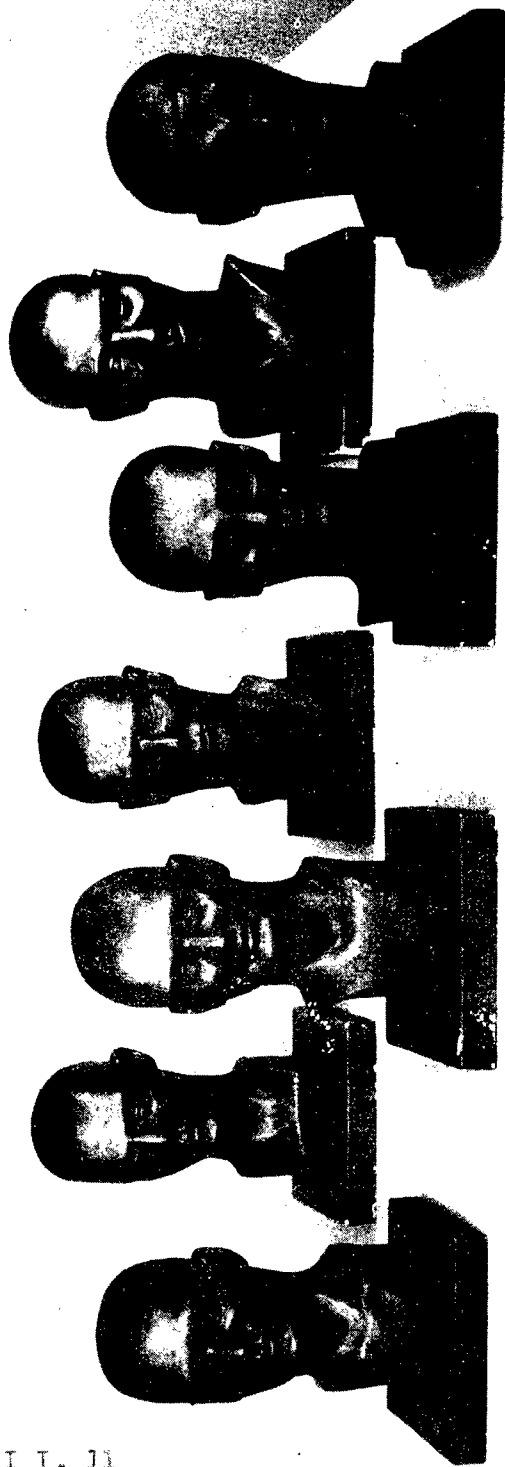

Figure I.I, II

DISTRIBUTION OF NASION-MENTON
for
OXYGEN MASK SIZES

Circumference	Fighter & Commissioned		Enlisted		Total		Very Heavy		Flying		ROTC	
	Aviation Photo-Recon. Cadets	Pilots	Bombardment Airorew	Bombardment Airorew	Bombardment Airorew	Bombardment Airorew	Total Issue	Bombardment Airorew	WASP Nurses	Nurses	Nurses	Negroes
96-116 mm. (Small mask)	11.02	13.71	10.07	10.85	10.52	10.83	10.83	13.83	50.62	71.82	5.30	
117-132 mm. (Medium mask)	76.92	81.23	76.60	76.59	76.59	76.96	75.78	48.69	28.18	71.97		
133-152 mm. (Large mask)	12.06	5.06	13.33	12.66	12.99	12.21	10.37	0.69	0.00	22.73		

Figure III, 12.

However, experience has taught us that four sizes offer almost in geometrical proportion an increase in the distribution and supply problem over one size. Ideally then, the best possible oxygen mask would consist of a single size which would work perfectly on 100% of the individuals. However, no oxygen mask developed to date has succeeded in attaining this degree of perfection and the best possible compromise which has as yet been arrived at has been a system of three sizes adapted in such a manner as to fit about 98% of the personnel.

Since, to date, three sizes of mask have been found to be most satisfactory for general use, the following discussion will be based upon this theory.

Referring solely to the male white information, it will be seen from the graph, Figure III, 13, that the extreme ranges are 101 mm. and 146 mm., giving us a total of 46 mm. of variation in the face length. This entire range has been divided for practical purposes into three approximately equal thirds, a short 15 mm., a middle 15 mm., and a long 16 mm. It will be seen that each one of these thirds represents slightly over 1/2 inch, and, as seen above, no mask utilized to date will tolerate more than 1/2 inch. Therefore, under the best possible conditions there cannot be more than a middle 12 mm. with a short and long group of 12 mm. each, giving us a total of 36 mm. available for three sizes of mask. Under the best conditions, a three size system of oxygen masks can then be expected to cover 36/46 of the entire range. In order, then, to get the best possible use out of the three sizes of masks, we must insure that the medium size of the mask fits first the middle 12 mm. in the entire range, and that the short or small size fits the next lower 12 mm., and the large size the next longer 12 mm. Even this approach requires that the small size mask shall fit everybody falling at its upper range because if it does not the medium must take up this difference and fit faces which are smaller than it was designed to cover. Similarly, the same fact holds for the relationship between the medium and large sizes. Therefore, it is quite often necessary to allow a certain degree of overlap between small and medium sizes in tolerance and between medium and large sizes, which will further reduce the extreme range which can be accommodated. Even so, realizing these limitations, if the masks are properly designed to size requirements, it should still be possible to fit over 90% of the population involved in these three sizes. Actually, experience with the A-14 mask has indicated that better than 98% can be fitted, allowing some discomfort on the very small and the very large faces.

The only possible way seen at present to be able to gain more than the 1/2 inch size tolerance from any one size mask is to design the mask in such a manner that it may be permitted to fluctuate to some extent vertically on the chin. This may be attained in two or more ways. One, by building a very low chin and allowing it to slide back and forth on the chin, or, two, by building a mask which sits on the frontal aspect of the chin rather than under it. The latter case was initially tried on the A-13 oxygen mask and it was found that a

NASION-MENTON FREQUENCY
1450 CADETS

SHORT 15MM. MIDDLE 15MM. LONG 16MM.

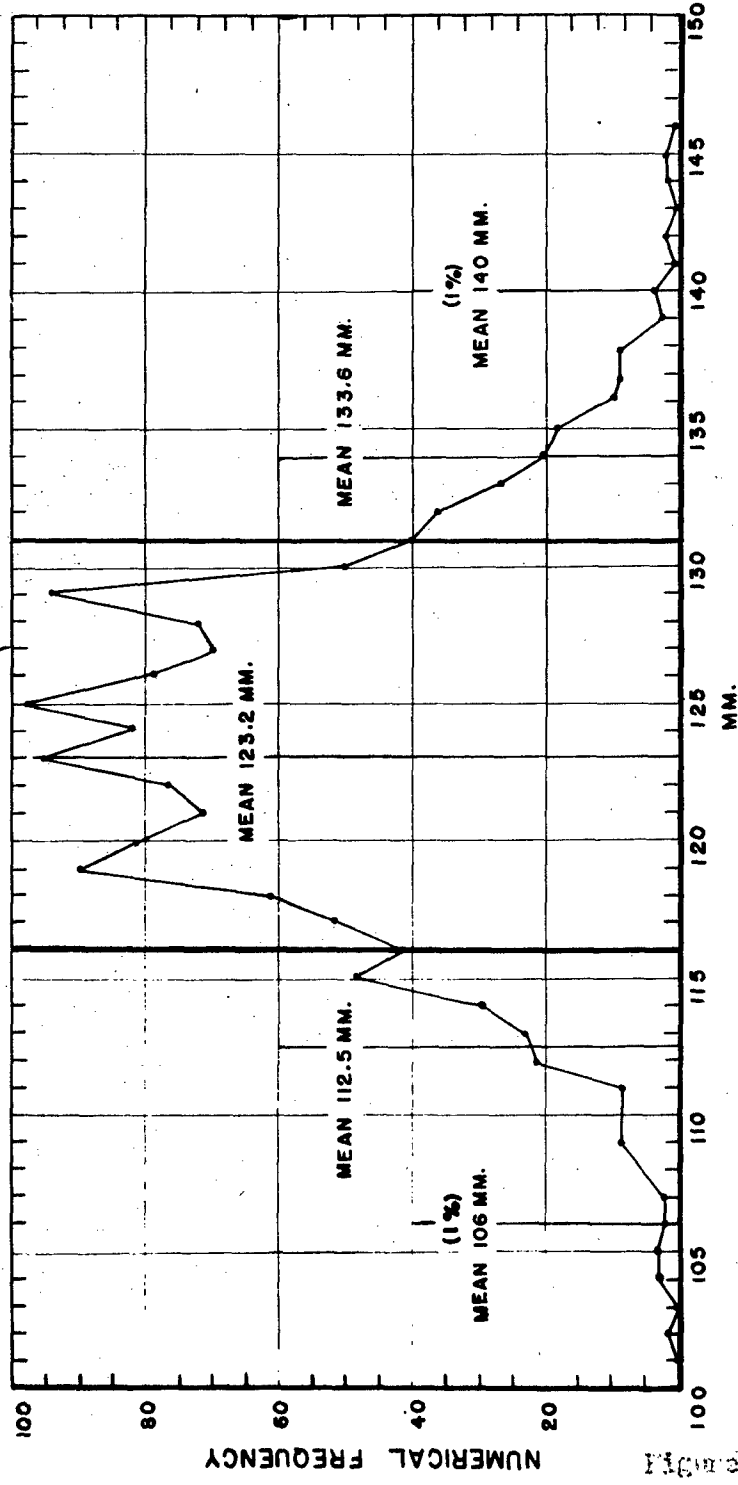

4575U AML

Fig. 10. 15. 1941

wide range of tolerance could be obtained. However, the necessity for adding chin and cheek protection against flash burn and frostbite cut down this high degree of tolerance somewhat. The final answer to this problem is in the future of oxygen mask design.

So far we have dealt only with the gross problem of size relationships in masks. There are many others of a more detailed nature which should be given in order that they may be considered in any future work along these lines. First is the very difficult problem of assaying a mask's behaviour in terms of its relationship to the bony portion of the nose. The lower edge of the nasal bones usually lies at an angle of about 45 degrees to the horizontal and to some extent will limit the manner in which the nasal portion of the mask may be designed. It is highly essential from the standpoint of comfort that an oxygen mask does not contact the nose below this lower margin of the nasal bones. If it does it will easily restrict the nares enough to restrict respiration. This appears on the surface to be a rather simple problem, but the fact that a constriction of only $1/32$ of an inch is sufficient to restrict breathing will indicate how difficult it is to stay away from this result. Therefore, geometrically speaking, we are working with a triangular area on the nose which is about 12 mm. long on the short side and 29 mm. long on the base. These two sides intersect at approximately right angles and the other side of the triangle would then be about 31 mm. These dimensions, of course, are average and the variations involved, particularly on the longer of the two sides referred to, may go down to as low as 20 mm. on small or medium faces, and will, of course, be the determining factors in the nasal aspect of the mask itself.

Tied up with this relationship to the nasal bones is the very real operational problem of compromise with the fit of the goggles over the mask in order to obtain the maximum possible visual field, and also to retain the maximum degree of comfort. Operationally speaking, it has been found that the determining factor on the use of an oxygen mask so far as its relationship with the goggles is concerned is that related to comfort. If the mask is not comfortable we can expect trouble. If it is comfortable, the man will tolerate some visual restriction. This does not mean, however, that we should ignore the attempt to get as much visual field as possible from the combined pieces of equipment, and every effort should be made in the development of masks and goggles together to attain the fullest degree of integration between them.

There are certain basic criteria which can be adhered to in getting first approximations to the minimum restriction of vision with the maximum degree of comfort. The first one is the factor involved in the relationships to the bony portion of the nose. The second is the minimum allowable clearance between the mask itself and the nose. It certainly should not be below $1/8$ inch, because any tension on the mask will cause it to "mush" into the face and further reduce this difference. Direct contact between the fleshy nose and the nasal portion of the mask should not be permitted because it will immediately introduce the factors of nasal restriction again. Using this minimum dimension, the next factor which must be considered is the thickness of the mask, itself,

over the nose, which must be as low as possible, and the angular relationship of the nasal portion of the mask, which should be as nearly parallel as possible to the most pronounced nose to be encountered and this can reach as high as 40 mm. angular dimension at the broadest part of the nose.

Next comes the consideration of the physical requirements of the mask as a piece of equipment. As noted above, the ideal number of sizes is one, but when it comes to the physical aspect of the mask in terms of weight the absurd ideal is that it weigh nothing. It shall have no bulk. This, of course, is an impossibility, so the objective, then, is to hold the weight and the bulk to the lowest practicable minimum. The first factor to consider in attaining these objectives is to retain in the design the smallest possible internal volume which can be tolerated by the face. This sounds easy enough to attain, but at the present time we must still consider the requirements introduced by the sizes of the best possible valves and microphone to be installed in the mask, and every attempt to hold the internal volume down is thwarted to some extent by the addition of the necessary valve systems. Because of the limitations offered by the valve systems, it therefore becomes necessary to give further consideration to the possibilities of reducing the sizes even lower.

Detailed data on the techniques of measuring the human head will be found in the appendices. (Appendix 2).

FLYING CLOTHING

COVERALL TYPE

Coverall type flying suits are most usually produced in the summer or other light forms.

At the time the program of size check of Army Air Forces' flying clothing was initiated, production of the AN-S-31a flying coverall was under way. Materials, details of workmanship, and finished dimensions of these garments were specified. Manufacturers cut and graded their own patterns submitting one sample for approval before beginning production. It was the duty of the Army Air Force resident representative to check size by use of the dimensions given in the specification.

A check of items drawn from production runs indicated that manufacturers had widely varying ideas of what constituted a particular size of garment. Suits of the same labelled size varied as much as $7 \frac{1}{4}$ inches in one dimension, a situation which further complicated problems of procurement and issue. Specified finished dimensions to be checked by the resident inspectors obviously were not a satisfactory method of size control. As an expedient to reduce variability as much as possible, the make of coverall which showed the fewest deviations from specified tolerances was selected and tested on a range of body

sizes to determine adequacy of coverage. When these points were established, the patterns used by this manufacturer were copied and sent to all other manufacturers.

When the F-1 and L-1 flying suits were projected, the standard procedure outlined above was followed. Later comparisons demonstrated that not only had variability been reduced considerably, but also the small variation present had been fairly well stabilized in manufacture.

Sizing procedures conducted on the K-1 and L-1 suits should be applicable to any other coverall garment designed in the future. Distribution charts, such as those shown in Figures III, 14; III, 15; III, 16; III, 17; and III, 18 will do much to guide the observer. Care, however, must be taken to check these charts against any new types of flying populations before they can be utilized directly. If a check series shows much deviation from that shown in the charts, entirely new charts must be prepared.

TWO-PIECE TYPE

Two-piece garments are usually prepared for intermediate, heavy, and electrically-heated suits.

Predecessors of the intermediate weight flying clothing were the A-3, B-3, and AN-J-4 - AN-T-35 shearling suits. Certain developments of heavy clothing followed them, but these were never extensively used since the intermediate type worn over electrically heated clothing served the same purpose.

An analysis was first made of this shearling clothing to determine how well it was filling its functional requirements and what changes could be foreseen as necessary in later clothing of that general type. The following shortcomings were noted:

- 1) A need for one size (34) smaller than was being manufactured, and the manufacture of two sizes (46 and 48) larger than needed.
- 2) Design specifications not based on the actual group to be fitted, resulting in sleeves too long and waists too large for the basic measurement of chest girth, etc.
- 3) A confusing system of size labelling, with the same label (applying only to chest girth) found on both the jackets and trousers, thus ignoring the range of waist size found with each chest size.
- 4) Constructional features which increased bulk unnecessarily and retarded functional efficiency.

The first intermediate flying suit (B-10 jacket, A-9 trousers), already in production when routine size analysis was undertaken, partook of most of the faults outlined above, with the addition that issue experience indicated the jacket was running one size too small. For example, the first size specifications called for a trouser waist only two inches less than the chest girth of the

individual. This meant that practically every man wearing a jacket which fitted him would find the trousers entirely too large since the average drop from chest to waist is six inches, with jacket and trouser always being issued as a unit. In later specifications the differential was increased to four inches.

With the standardization of the B-15 jacket and A-11 trouser, the inadequacies apparent in earlier flying suits of this type were eliminated. Size control was exercised from the design stage onward through the use of preliminary size tests and routine check measurements. Both this suit and its successor, the B-15a, A-11a combination, showed remarkable consistency in adherence to standards despite the large number of manufacturers making them. These two types of intermediate suit demonstrate the high degree of stability that can be obtained by proper supervision and control from design through production.

ELECTRICALLY-HEATED SUITS

The history of the application of sizing techniques and predicted procurement schedulings to electrically heated clothing is the most incomplete and unrewarding of any of the projects undertaken on flying clothing. This was largely due to the fact that electrically heated clothing was a critical item throughout the war, and, as such, its designs and procurements were rushed in every case. As a result, size evaluation and testing were post facto. However, several lessons were learned as to what not to do.

The F-1 electrically heated flying suit, a coverall type garment, did not come within the jurisdiction of the sizing program since its production was completed by that time. Later examination indicated that sizing from the standpoint of the design specifications was faulty.

The F-2 suit was already well in production when the first one was size tested. However, difficulties had been experienced and modifications made from the start of production. The first size analysis demonstrated serious faults, particularly in the trousers, but shortages apparent in supply reports show that these had not been satisfactorily dealt with by the time the F-2 was being replaced by the F-3.

Estimates of size coverage and predicted procurement scheduling for the F-3 suit were made on the basis of design specifications; no samples were available as it was felt that to manufacture them and conduct fitting trials would consume too much time. Later, when production had begun and sizing samples were available, testing revealed that three sizes of jacket and one size of trouser could be eliminated. Meanwhile, all of the original sizes were being manufactured. Further to speed up production, the initial orders placed had all been for one size. Thus the procurement scheduling provided after fitting trials never was followed or even approximated.

Not long after issue began, overseas reports indicated serious shortages,

but, by then, analysis necessary to clarify the difficulty was blocked by a number of factors:

- 1) The F-3 suit had never been produced according to the sizes and percentages recommended so that there was no basis for starting such analysis.
- 2) No breakdown of the percentages of sizes in individual shipments to overseas theaters was available.
- 3) No data were available on how the suits were issued or how they were fitted; and on a critical item knowledge of this is particularly important since issue may well not follow desired size too closely.
- 4) No data were available on what was worn under the suits. Work on sizing had indicated that a relatively minor increase in the bulk of underclothing beyond that recommended for wear could shift percentages required considerably.

Thus, although the recommended procurement scheduling was supported by an issue and service test conducted in the zone of the interior, it must remain a moot question for overseas issue. This history of electrically heated clothing raises the question of whether any article is ever so critical as to warrant the disregard of adequate design and size analysis. The speed of initial production must be balanced against later delays incident to design changes, shifts in production, flights lost due to lack of equipment, etc.

Garments made in two pieces should be tested for size on charts shown in Figures III, 19; III, 20; III, 21; III, 22; III, 23; III, 24. Again it should be emphasized that these charts are typical, and should not be construed as representative of any population until after a check series has been measured and proved.

STATURE AND CHEST TOTAL BOMBARDMENT
RATIO 6 ENLISTED MEN: 4 OFFICERS **PERCENTAGES**

STATURE	CHEST												
	32	33	34	35	36	37	38	39	40	41	42	43	
60													
.5				0.096		0.096							0.192
61					0.096								0.096
.5													
62		0.096	0.192	0.096	0.192								0.576
.5	0.096	0.096			0.096								0.288
63	0.096			0.096	0.192	0.096	0.096		0.096				0.672
.5	0.096									0.096			0.192
64		0.192	0.288	0.096	0.096	0.192	0.288		0.096				1.248
.5		0.096	0.096	0.866		0.678		0.096					1.832
65		0.096		0.192	0.294	0.390	0.192	0.096	0.096				1.356
.5			0.476	0.582	0.774	1.160	0.582	0.096		0.096			3.766
66			0.486	0.480	0.770	0.774	0.288	0.096					2.894
.5				1.058	0.962	1.068	0.678	0.192	0.192				4.150
67				0.774	1.068	1.362	0.294	0.486	0.192		0.192		4.368
.5		0.096	0.972	1.266	1.934	1.646	1.458	0.582	0.870	0.192			9.016
68			0.480	0.972	1.646	1.544	1.058	0.866	0.192		0.096		6.854
.5			0.486	1.154	1.346	1.848	1.346	0.582	0.096	0.390		0.096	7.344
69		0.192	0.288	0.582	1.058	1.742	1.058	0.384	0.288	0.192	0.096		5.880
.5		0.384	0.688	1.544	3.676	2.900	1.934	2.024	0.876	0.572			14.578
70	0.096		0.774	0.572	1.160	1.448	0.866	0.582	0.192	0.288	0.096		6.074
.5			0.288	0.486	1.448	1.448	1.068	0.780	0.384	0.192	0.192		6.286
71			0.096	0.870	0.572	1.448	1.068	1.352	0.288	0.096	0.288		6.078
.5				0.288	0.972	1.726	1.844	1.160	0.674	0.288		0.096	7.048
72				0.096	0.288	0.582	0.384	0.096	0.096	0.096		0.096	1.734
.5				0.096	0.192	0.480	0.678	0.582	0.096	0.096	0.096		2.316
73			0.288	0.486	0.386	0.476	0.582	0.096	0.288	0.192			2.794
.5					0.096	0.096	0.192		0.096	0.096	0.096		0.672
74							0.096	0.192	0.096	0.288			0.672
.5					0.096	0.192	0.096	0.096					0.480
75							0.096						0.096
.5					0.096			0.096					0.192
76													
.5						0.096							0.096
	0.38	1.25	5.88	12.75	19.51	23.49	16.24	10.53	5.20	3.17	1.15	0.29	99.841

4375 P AML

Figure III, 14.

STATURE AND CHEST TOTAL ISSUE
RATIO I FIGHTER PILOT : 92 TOTAL BOMBARDMENT PERCENTAGES
CHEST

STATURE	32	33	34	35	36	37	38	39	40	41	42	43	44	
60														
.5				0.09		0.08								0.17
61					0.09									0.09
.5														
.62		0.09	0.14	0.09	0.17									0.49
.5	0.08	0.09			0.09									0.26
.63	0.09			0.08	0.17	0.08	0.11		0.08					0.61
.5	0.08				0.03					0.08				0.19
64		0.17	0.26	0.15	0.12	0.23	0.26		0.08					1.27
.5		0.08	0.11	0.82	0.03	0.60		0.09						1.73
65		0.09	0.06	0.18	0.38	0.93	0.20	0.15	0.08					2.07
.5			0.47	0.60	0.72	1.20	0.55	0.12		0.08				3.74
66			0.52	0.56	0.77	0.71	0.26	0.09	0.06					2.97
.5		0.06	0.06	1.08	1.00	1.09	0.67	0.20	0.24					4.40
67			0.09	0.88	1.10	1.39	0.35	0.45	0.17		0.17			4.60
.5		0.15	0.89	1.37	1.90	1.66	1.57	0.58	0.87	0.18				9.17
68			0.47	0.99	1.54	1.48	1.11	0.85	0.21	0.03	0.09			6.77
.5		0.03	0.56	1.23	1.35	1.74	1.28	0.55	0.08	0.35		0.08		7.25
69		0.20	0.26	0.58	1.21	1.69	0.99	0.35	0.30	0.17	0.85			6.60
.5		0.36	0.66	1.40	3.49	3.01	1.08	2.03	0.87	0.56				14.20
70	0.08		0.70	0.66	1.23	1.53	0.81	0.58	0.21	0.29	0.09			6.18
.5			0.26	0.46	1.41	1.62	1.22	0.75	0.38	0.20	0.17			6.47
71		0.03	0.09	0.78	0.65	1.44	0.95	1.29	0.29	0.12	0.26			5.90
.5				0.26	0.92	1.81	1.82	1.14	0.68	0.32		0.09	0.32	7.36
72			0.03	0.09	0.36	0.65	0.42	0.09	0.12	0.09		0.09		1.94
.5				0.08	0.21	0.44	0.60	0.55	0.12	0.08	0.12			2.20
73			0.27	0.44	0.36	0.47	0.58	0.09	0.26	0.18				2.65
.5					0.09	0.08	0.18		0.09	0.09	0.09			0.62
74							0.08	0.18	0.09	0.27				0.62
.5					0.12	0.18	0.09	0.09						0.48
75							0.09			0.03				0.12
.5					0.09			0.09						0.18
76														
.5							0.09							0.09
	0.33	1.37	5.90	12.87	19.60	24.11	16.08	10.31	5.28	3.12	1.84	0.26	0.32	101.29

4275N AML

Figure III, 15.

STATURE AND CHEST
VERY HEAVY BOMBARDMENT

STATURE	CHEST													TOTAL
	32	33	34	35	36	37	38	39	40	41	42	43	44	
60.5														
61		.173												.173
61.5														
62				.173	.173									.346
62.5							.173							.173
63				.173										.173
63.5		.173			.173	.347								.693
64					.173			.173						.346
64.5				.347			.347	.173						.867
65	.173		.173	.347	.520	.520							.173	1.906
65.5			.173	.347	.694	.520	.347			.173				2.254
66			.173	1.215	.520	.347	.694	.347	.520	.173	.173			4.162
66.5		.173	.520	.173	.520	.868	.694			.173				3.121
67		.520	.694	.868	1.041	.520	.520	.173	.347		.173			4.856
67.5	.173	.173	1.041	1.041	1.041	1.909	.694	.868						6.940
68		.347	.347	1.388	1.041	1.562	1.562	.694	.868	.347				8.156
68.5			.347	.868	2.951	1.736	1.388	1.388	.694		.173		.173	9.718
69		.173		1.909	.868	2.951	2.256	.868	1.041	.694	.173			10.933
69.5		.347	.694	.868	1.041	1.041	1.215	1.388	.173	.347	.173	.347		7.634
70		.173	.520	.520	1.388	1.562	.868	1.562		.868	.173			7.634
70.5			.347	.520	1.041	1.909	2.083	1.215	.694	.173			.173	8.155
71			.173	1.562	.173	1.388	.347	1.041	.520	.520	.173			5.897
71.5			.173	.694	.520	.868	1.388	1.388	.347	.347	.347	.347		6.419
72				.173	.347	.694	1.562	.520	.347					3.643
72.5						.173		.520		.347	.347	.173	.173	1.733
73						.347	.347	.173	.173		.173			1.213
73.5							.173			.347	.173			.693
74							.520			.347				.867
74.5							.173			.173				.346
75								.173	.173					.346
75.5														
76														
76.5														
	.346	2.252	5.375	13.186	14.225	19.262	17.178	12.837	5.897	5.029	2.251	.867	.692	99.397

4391G AML

Figure III, 16.

STATURE AND TORSO BOMBARDMENT
RATIO 4 OFFICERS: 6 ENLISTED MEN PERCENTAGES
TORSO CIRCUMFERENCE

STATURE	58	59	60	61	62	63	64	65	66	67	68	69	70	71	72	73	
60																	
.5	0.10		0.11														0.21
61					0.10												0.10
.5																	
62	0.11	0.10	0.10	0.10	0.10		0.11										0.62
.5	0.11	0.10			0.11												0.32
63		0.10		0.11	0.21		0.11										0.53
.5				0.11	0.21												0.32
64	0.10		0.20	0.21	0.63	0.11	0.11										1.36
.5		0.11		0.31	0.61	0.20	0.19	0.11	0.11								1.64
65			0.20	0.20	0.40	0.43	0.11										1.34
.5	0.10		0.50	0.63	0.52	1.02	0.82										3.59
66			0.10	0.62	1.01	0.31	0.61	0.11									2.76
.5		0.11	0.21	0.71	1.11	0.51	1.03	0.21	0.10								3.99
67			0.32	0.21	0.84	1.06	0.82	0.62	0.21	0.21							4.29
.5		0.10	0.31	0.41	1.25	2.37	1.55	2.17	0.73	0.19	0.10	0.10					9.28
68			0.20	0.73	0.71	1.72	1.59	0.94	0.71	0.10	0.11						6.81
.5				0.31	1.27	1.44	1.34	1.73	0.81	0.40	0.11						7.41
69				0.11	0.41	1.63	0.91	1.37	1.23	0.10	0.21	0.11					6.08
.5			0.11	0.19	1.22	3.25	2.55	2.54	2.65	1.42	0.70	0.10					14.73
70				0.10	0.20	0.50	1.40	1.72	1.63	0.21	0.20	0.19					6.15
.5				0.11	0.11	0.62	1.01	1.35	1.33	0.89	0.32	0.32					6.06
71						0.30	1.23	1.30	1.54	0.79	0.81						5.97
.5					0.19	0.10	0.31	2.05	1.73	1.63	0.70	0.10	0.31	0.11			7.23
72								0.20	0.40	0.59	0.30	0.11	0.19				1.79
.5								0.11	0.41	0.49	0.74	0.40		0.11			2.26
73					0.11	0.11	0.10	0.40	0.68	0.79	0.40	0.10	0.11	0.10			2.90
.5										0.19	0.30	0.10		0.10			0.69
74									0.10	0.10	0.10		0.11	0.19		0.10	0.70
.5									0.10		0.29			0.10			0.49
75												0.10					0.10
.5											0.10			0.10			0.20
76																	
.5										0.10							0.10
	0.52	0.62	2.36	5.17	11.32	15.68	16.01	17.23	14.55	8.45	5.15	1.33	0.83	0.70		0.10	100.02

4375-0 AML

Figure III, 17.

STATURE AND TORSO CIRCUMFERENCE **TOTAL ISSUE**
RATIO 1 FIGHTER PILOT: 9.2 TOTAL BOMBARDMENT **PERCENTAGES**
 TORSO CIRCUMFERENCE

STATURE	58	59	60	61	62	63	64	65	66	67	68	69	70	71	72	73	
60																	
.5	0.09		0.10														0.19
61					0.09												0.09
.5																	
62	0.10	0.09	0.09	0.09	0.09		0.10										0.56
.5	0.10	0.09			0.10												0.29
63		0.07	0.04	0.10	0.21		0.10										0.52
.5		0.03		0.10	0.18												0.31
64	0.09	0.03	0.24	0.24	0.56	0.10	0.10										1.36
.5		0.10	0.06	0.31	0.55	0.18	0.18	0.10	0.10								1.58
65				0.24	0.42	0.38	0.13	0.03									1.20
.5	0.09			0.62	0.55	1.11	0.74	0.03									3.14
66				0.61	1.04	0.44	0.55	0.10	0.03								2.77
.5		0.10	0.21	0.86	0.13	0.58	1.01	0.24	0.09								4.22
67		0.03	0.34	0.24	0.96	1.09	0.90	0.64	0.18	0.18							4.56
.5	0.03	0.09	0.42	0.40	1.36	2.37	1.89	2.03	0.68	0.21	0.09	0.09					9.46
68			0.18	0.73	0.73	1.59	1.59	1.02	0.67	0.12	0.10						6.73
.5				0.31	1.27	1.48	1.39	1.69	0.73	0.36	0.10						7.33
69				0.13	0.40	1.65	0.95	1.33	1.13	0.09	0.21	0.10					5.99
.5			0.13	0.25	1.16	3.18	2.52	2.38	2.58	1.34	0.67	0.15					14.36
70				0.09	0.18	0.58	1.47	1.65	1.59	0.27	0.21	0.18					6.22
.5				0.10	0.10	0.61	1.08	1.36	1.53	0.85	0.34	0.31					6.28
71						0.34	1.16	1.31	1.41	0.78	0.73		0.03				5.76
.5					0.18	0.12	0.44	1.96	1.69	1.52	0.76	0.15	0.28	0.10	0.03		7.23
72					0.03			0.06	0.27	0.43	0.60	0.28	0.10	0.21			1.98
.5								0.10	0.37	0.46	0.71	0.36	0.03	0.13			2.16
73					0.10	0.10	0.09	0.35	0.66	0.72	0.40	0.12	0.10	0.09			2.73
.5											0.18	0.28	0.09		0.09		0.64
74										0.09	0.09	0.09		0.10	0.18	0.09	0.64
.5										0.12		0.27			0.09		0.48
75													0.12				0.12
.5												0.09			0.09		0.18
76																	
.5										0.09							0.09
	0.50	0.63	1.81	5.42	11.39	15.90	16.35	16.86	14.17	8.11	4.98	1.44	0.85	0.64	0.03	0.09	99.17

4375 M AML

Figure III, 18.

CHEST AND SLEEVE HEAVY BOMBARDMENT
RATIO 6 ENLISTED MEN : 4 OFFICERS PERCENTAGES

SLEEVE

CHEST	28	29	30	31	32	33	34	35	36	37	
32	0.21	0.10				0.10					0.41
33	0.19	0.19	0.41	0.20	0.31						1.30
34	0.31	0.40	1.66	1.82	1.39	0.19					5.77
35	0.30	0.92	2.86	3.38	3.86	1.18	0.32				12.82
36	0.20	1.14	2.90	6.92	6.04	2.18	0.20				19.58
37	0.11	1.25	3.23	7.10	6.72	3.55	0.98	0.10			23.04
38	0.11	0.52	2.08	4.82	4.92	3.08	0.82	0.10			16.45
39		0.11	0.81	2.76	3.80	2.75	0.69	0.10			11.02
40		0.21	0.63	1.12	1.45	1.28	0.30		0.10		5.09
41			0.32	0.50	0.83	1.01	0.38				3.04
42			0.20	0.20	0.41	0.10	0.30				1.21
43				0.11		0.10	0.10				.31
	1.43	4.84	15.10	28.93	29.73	15.52	4.09	0.30	0.10		100.04

4383 -F- AML

Figure III, 19.

CHEST AND SLEEVE TOTAL ISSUE
RATIO 1 FIGHTER PILOT : 9.2 TOTAL BOMBARDMENT PERCENTAGES

SLEEVE

CHEST	28	29	30	31	32	33	34	35	36	
32	0.18	0.09				0.09				0.36
33	0.18	0.21	0.43	0.27	0.34					1.43
34	0.28	0.43	1.79	1.78	1.40	0.18				5.86
35	0.28	0.95	2.85	3.56	3.87	1.15	0.28			12.94
36	0.21	1.11	2.84	6.97	5.94	2.29	0.21			19.57
37	0.10	1.13	3.26	6.86	7.04	3.81	1.10	0.03		23.33
38	0.10	0.52	1.94	4.70	4.82	3.11	0.83	0.12		16.14
39		0.13	0.79	2.65	3.78	2.64	0.67	0.09		10.75
40		0.18	0.62	1.10	1.57	1.25	0.31	0.15		5.18
41			0.28	0.49	0.77	0.98	0.39	0.06	0.09	3.06
42			0.18	0.18	0.36	0.09	0.31			1.12
43				0.10		0.09	0.09			0.28
44							0.03			0.03
	1.33	4.75	14.98	28.66	29.89	15.68	4.22	0.45	0.09	100.05

4383-B-AML

Figure III, 20.

SLEEVE AND CHEST
VERY HEAVY BOMBARDMENT

	SLEEVE												
CHEST	27	28	29	30	31	32	33	34	35	36	37	38	
32					.352								.352
33			.352	.528	.704	.176	.528	.176					2.464
34		.176	.176	.704	1.584	1.232	1.056	.176					5.104
35	.176	.176	.704	1.056	5.105	3.697	1.936	.528	.176				13.554
36			.176	2.112	3.345	4.577	2.464	1.056					13.730
37			.704	1.584	4.577	5.809	3.697	1.936	.528				18.835
38			.352	1.584	1.408	5.633	4.929	2.288	.704	.352			17.250
39			.176	.880	.880	4.577	3.697	1.936	1.232		.352		13.730
40				.528	1.408	1.760	1.408	.528	.352				5.984
41			.176		.528	1.056	1.408	.880	.704		.176		4.928
42					.528	.176	1.056	1.176	.352			.176	2.464
43					.176		.352	.352					.880
44						.352	.176	.176					.704
	.176	.352	2.816	8.976	20.595	29.045	22.707	10.208	4.048	.352	.528	.176	99.979

4391F AML

Figure III, 21.

WAIST AND INSEAM HEAVY BOMBARDMENT
RATIO 6 ENLISTED MEN:4 OFFICERS PERCENTAGES

	INSEAM												
WAIST	27	28	29	30	31	32	33	34	35	36	37	38	
26	0.10		0.10										0.20
27					0.20	0.11		0.10					0.41
28		0.10	0.21	0.51	0.51	1.49	1.11	0.21	0.17				4.31
29	0.10	0.40	1.02	1.52	3.05	2.54	2.11	0.67	0.29				11.70
30	0.19	0.31	1.34	1.95	4.29	5.99	4.72	1.62	0.61		0.10		21.12
31		0.31	1.23	3.39	4.99	6.26	4.48	1.84	1.13	0.11			23.74
32	0.11	0.11	0.82	2.69	3.26	3.88	4.89	2.81	1.01	0.11		0.10	19.79
33		0.11	0.52	1.31	2.26	1.51	1.85	1.52	0.10	0.10			9.28
34		0.11	0.40	0.60	1.03	1.44	1.02	0.10	0.17				4.87
35			0.19	0.11	0.42	0.81	0.28	0.58	0.28				2.67
36					0.30	0.30	0.20	0.10					0.90
37		0.11	0.11			0.42	0.11						0.75
38						0.11							0.11
39			0.11			0.10							0.21
	0.50	1.56	6.05	12.08	20.31	24.96	20.77	9.55	3.76	0.32	0.10	0.10	100.06

4383A-AML

Figure III, 22.

WAIST AND INSEAM TOTAL ISSUE
RATIO I FIGHTER PILOT : 92 TOTAL BOMBARDMENT PERCENTAGES
INSEAM

WAIST	27	28	29	30	31	32	33	34	35	36	37	38	
26	0.09		0.09			0.03							0.21
27					0.24	0.13		0.15					0.52
28		0.09	0.21	0.58	0.71	1.71	1.23	0.27	0.19				4.99
29	0.09	0.36	0.98	1.71	3.16	2.85	2.22	0.79	0.27				12.43
30	0.18	0.28	1.26	2.03	4.35	5.97	4.74	1.75	0.61	0.03	0.09		21.29
31		0.28	1.13	3.12	5.05	5.98	4.37	1.90	1.10	0.10			23.03
32	0.10	0.13	0.77	2.62	3.22	3.74	4.60	2.80	0.95	0.10		0.09	19.12
33		0.13	0.46	1.38	2.11	1.56	1.88	1.43	0.09	0.09			9.13
34			0.36	0.58	0.92	1.38	1.01	0.25	0.19				4.69
35			0.18	0.10	0.40	0.76	0.22	0.57	0.26	0.03			2.59
36					0.28	0.31	0.18	0.09					0.86
37		0.10	0.10			0.37	0.10						0.67
38						0.10							0.10
39			0.10			0.09							0.10
	0.46	1.37	5.64	12.12	20.44	24.98	20.62	10.00	3.66	0.35	0.09	0.09	99.82

4383-D- AML

Figure III, 23.

**INSEAM AND WAIST
VERY HEAVY BOMBARDMENT**

WAIST	INSEAM													
	26	27	28	29	30	31	32	33	34	35	36	37	38	
26							.521	.173						.694
27				.173	.347	.347	.347	.173						1.387
28				.347	.695	.521	1.565	.869	.347	.173	.173			4.690
29		.173	.347	.869	1.043	2.782	3.130	.869	2.260	.521	.173			12.167
30				.521	1.565	3.478	3.304	5.043	3.304	.869	.173			18.257
31			.347	.695	1.391	4.000	5.217	5.217	2.782	1.217	.173			21.039
32			.173	.173	1.217	2.434	4.521	2.956	2.434	.521	.521	.347		15.297
33			.347	.521	.869	.869	3.304	2.434	2.086	.521	.173			11.124
34			.173	.173	.347	1.391	1.913	1.565	1.043	.521				7.126
35				.347	.521	.521	1.043	.869	.173					3.474
36					.521	.521	1.043	.173	.347					2.605
37					.173	.173	.347	.173	.173					1.039
38				.173			.173	.173						.519
39							.173		.173					.346
40					.173									.173
	.173	1.387	3.992	8.689	17.037	26.601	20.687	15.122	4.343	1.386	.347			99.764

4391D AML

Figure III, 24.

GLOVES

The sizing program as it related to gloves was not completed by the conclusion of World War II. Progress is evidenced by the fact that all types of gloves had been size tested and procurement schedules drawn up. Likewise, the mechanical means of adequate inspection of the stretched width of gloves in the form of an inside caliper, known as a glove-size gauge was developed. By this device the amount of pressure applied is uniform, assuring a constant stretch tension in the measurement of the glove, thus eliminating the variable factors of strength and skill of the inspector. Figures III, 25 and III, 26. But the glove manufacture, itself, is complicated by alternatives which apply to measurement and cutting:

- 1) Two types of measurement scale may be used involving the English inch and the Paris inch.
- 2) Two types of hand measurement may be used, circumference with the hand flexed and circumference with the hand extended.
- 3) Two types of gloves, one in which measurement is taken with the leather fully stretched and the other in which stretch measurement cannot be used (block or clicker cut gloves).

Combinations of these might also occur; specified finished dimensions in English rule, leather dimensions in French rule, etc. Add to this a large number of manufacturers working on relatively small, short time contracts, plus serious shortage of well trained inspectors and the outlook for efficient size control is dark.

Hand measurements taken on Army Air Force flyers consisted of a length and a breadth dimension. Hand circumference, which is assumed to be the most important measurement for glove size in a scheme of general issue, was found to be highly correlated with hand breadth ($.94 \pm .02$) making possible the direct use of the latter measurement for size scheduling. In size testing both hand circumference and hand breadth were taken on all subjects, the former used to assess glove size in relation to hand size, and the latter as an index of how closely the test series was approximating the range of hand size found in the large series. Figure III, 27.

The earliest work on size testing of gloves indicated serious difficulties which shall be discussed as they apply to particular types.

F-2 and F-2A Gloves: Like other electrically heated clothing, these items were critical throughout production and the usual difficulty was experienced in obtaining samples for use in size analysis. The first size test, performed on two gloves (sizes 9 and 10), the only ones which could be spared, clearly demonstrated that the finger circumference dimensions in the size 9 were much too small even for some size 8 hands. This size anomaly was brought to the attention of the agencies concerned, and, with the assurance that it would be corrected immediately, a scheduling was provided.

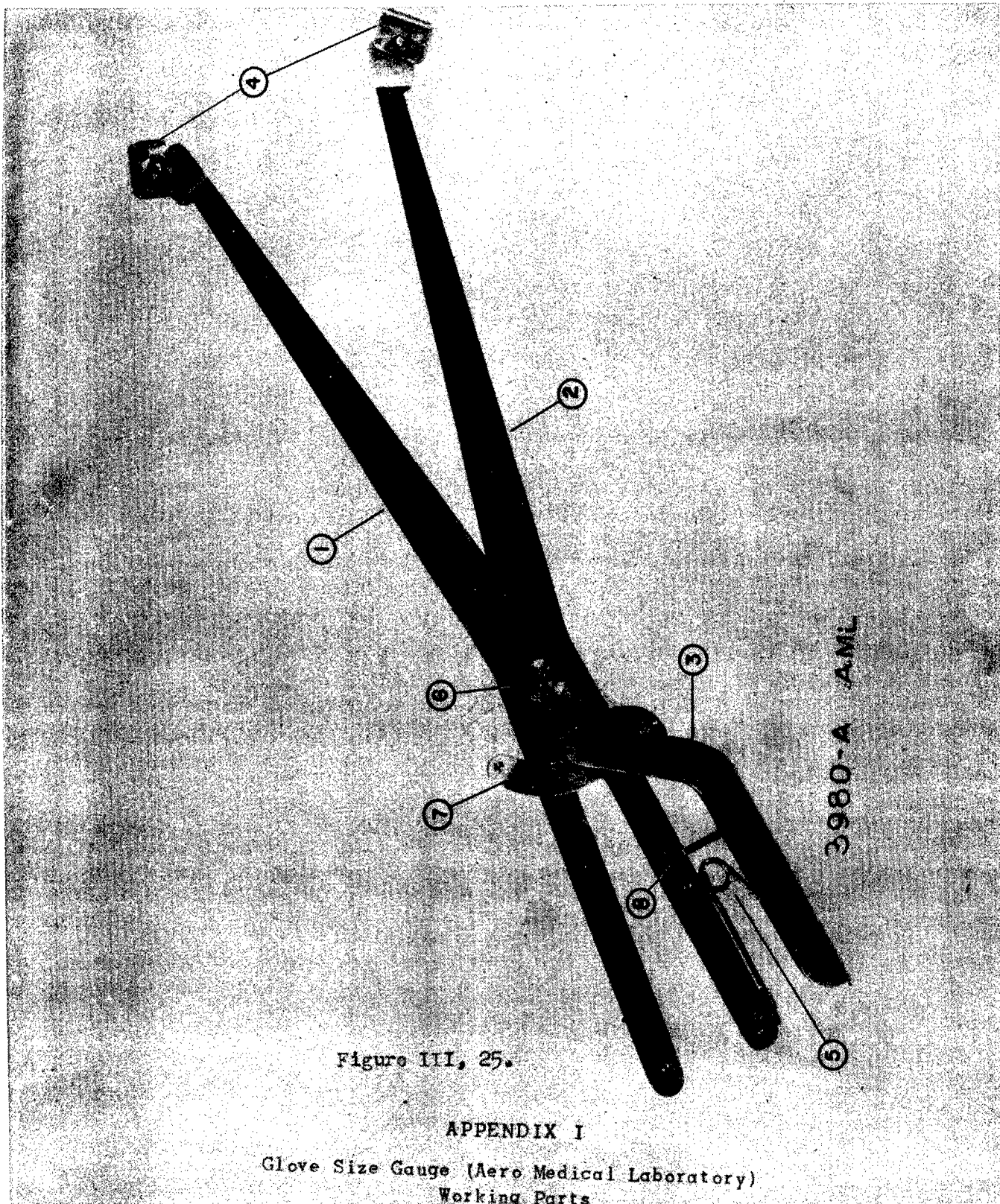

3980-A AML

Figure III, 25.

APPENDIX I

Glove Size Gauge (Aero Medical Laboratory)
Working Parts



Figure III, 26.

HAND BREADTH / HAND CIRCUMFERENCE

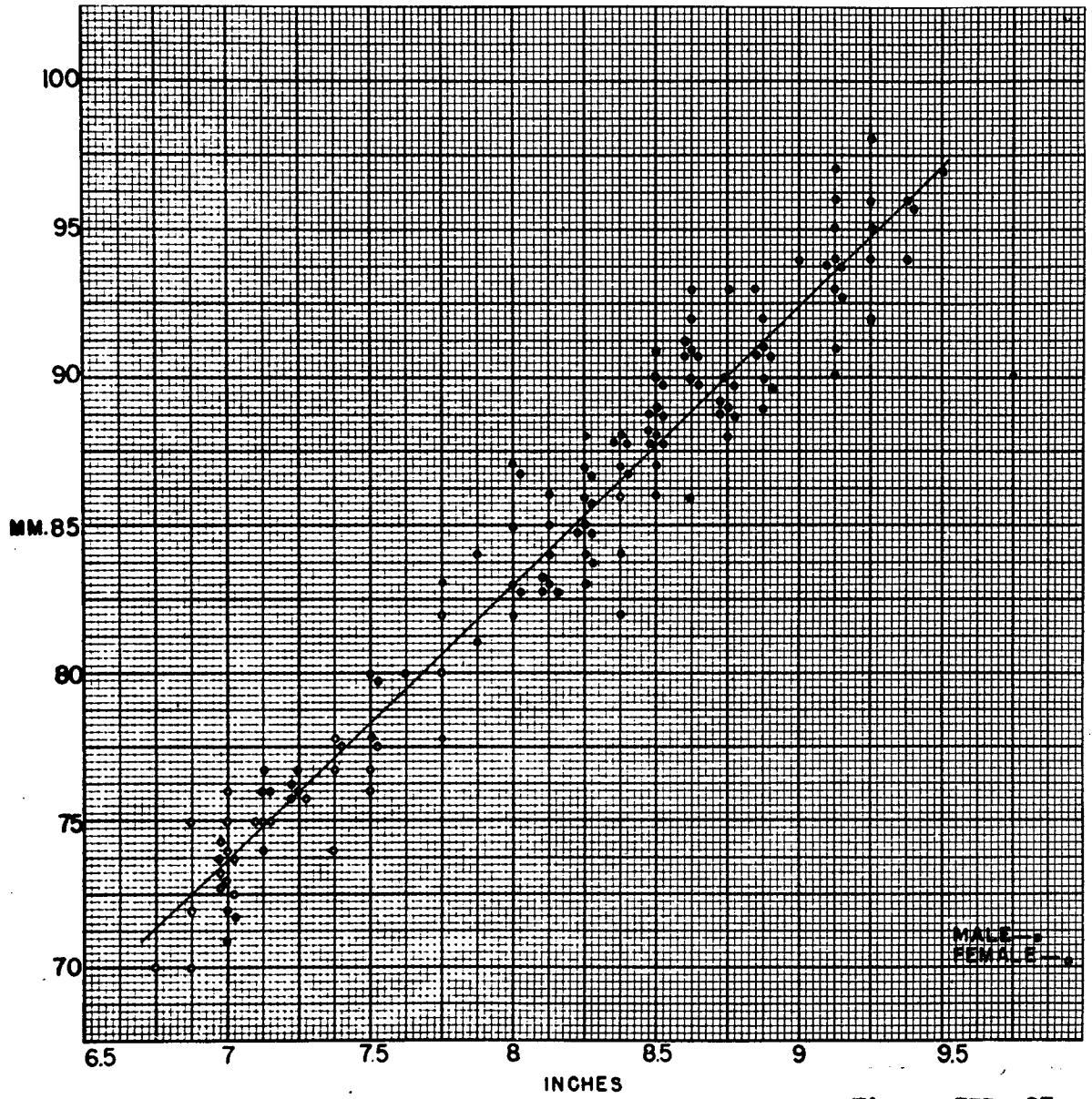

Figure III, 27.

4420A AML

Some five months later, no production samples having been received on this "critical" item in the meantime, information from issue points proved that the required change never had been made. It was explained that this change was to be incorporated in another revision which would result in a new type of pattern and that production of the new pattern had been delayed. This experience pointed up the difficulties of inadequate follow-up to insure prompt remedial action.

At the same time it was learned that the F-2 scheduling had been applied to procurement of every type of glove being manufactured for the Army Air Forces, apparently on the naive assumption that a schedule for one glove could equally well be applied to any other. A new scheduling was provided with the hope of balancing off with the original production scheduling, and recommendations were made for revision of the stretched width of the leather shell. However, within a few months of the end of hostilities in Europe, production reports were far out of line with the recommended schedule.

B-3 and B-3A Gloves: Size test of the B-3 glove on ninety-three male subjects showed that while thirty-eight took a labelled glove size corresponding to their hand size, fifty-five chose a glove from one to two labelled sizes larger than their hand size. With this in mind, as a preliminary to size test and procurement scheduling of B-3A gloves, an extensive examination was conducted on production size samples to determine the degree of adherence to specified dimensions. Of forty gloves, representing eight manufacturers, twenty-two were found whose leather measurements were not within the tolerance for their labelled size.

On the basis of this examination six pairs of gloves of each size were drawn from the production run of every manufacturer and similarly examined. This procedure verified the results of the previous examination, namely, that the gloves were more frequently outside than within the acceptable tolerance. Additional check was made at a specialized depot and steps were taken to tighten up on inspection requirements.

During the inspection one set of each type of B-3A glove (PK, Guage, and Deerskin) was selected for conformance to minimum size in leather measurements. These were used in a size test which formed the basis for recommended procurement scheduling. Meanwhile specification change for finished stretched width of the gloves was initiated.

A-11A Gloves: Investigation of this type of glove followed the same lines as that of the B-3A. The first inspection showed that twenty-eight out of forty-four gloves, representing six manufacturers, were outside specified tolerances. Similar production draws were made for further inspection and a size test was conducted on minimum size gloves.

A-9A Gloves: The first size test performed revealed that (1) the gloves did not conform to specified measurements, and (2) in the set examined, the thumb of the medium size gloves was much too small. Further work at a later

date on a series of gloves indicated that the specified measurements still were not being approximated. The inadequate thumb size was also found in other gloves of this type and action was initiated to correct it.

D-3 and D-3A Gloves: The first size test which employed D-3 gloves gave a curious distribution of glove size over a range of hand size: Small-0, Medium-7, Medium or Large (no choice)-6, Large-7. At the time this could be attributed to (1) inadequate size grading or (2) a wool insert that was too heavy. A later test on D-3A gloves with lighter wool inserts placed the blame on the size grading abetted by the fact that, being a cold weather glove, individuals preferred a relatively loose fit. This was further supported by the shortages which had developed in stock as evidenced by the fact that only the large size glove was being procured for some time before the end of hostilities. An extra-large size glove was also being considered for procurement.

A review of what has been done about glove size in relation to hand size and its ramifications into glove design and function during the war leaves a feeling that little of basic value has been accomplished. The problem was dealt with as one of covering hands with gloves already standardized and in production rather than that of first determining what the functional and size requirements of hands were and then setting out to satisfy them. Certainly a serious reconsideration of the entire problem is needed before any sizeable glove procurement is made again. Such an evaluation should take into account the following problems:

- 1) Functional requirements -- what is the glove intended for, what operations must be performed with it? Considerations such as these should vitally influence design.
- 2) Size requirements -- is hand circumference the only measurement that need be taken into account in a scheme for general issue; are hand and finger length equally important for an efficient glove?
- 3) Issue requirements -- granted a functionally efficient and well-sized glove, what steps can be taken to insure that every man is properly fitted at issue?
- 4) Inspection requirements -- the development of methods of inspection that can be rapidly and effectively employed by relatively unskilled individuals to insure correct manufacturing practise. The glove-size gauge is an answer but only one answer to this problem.

FOOTGEAR

Post Army Air Force footgear have not required individual fittings in length and width. Fit was generally specified by a range of foot or shoe size to be covered. This reduced the work in this field to manageable proportions requiring only a collection of information on sizes of shoes worn for an adequate sample of flying personnel, Figures III, 28; III, 29; III, 30; III, 31. Foot length and breadth were taken on the Cadet-Gunner anthropometric series and, later, on those groups measured for analysis of clothing size distribution, but plots of these dimensions against shoe lengths and widths worn indicated poor predictability of shoe size from foot dimensions. As an example, it was found that feet varying 1.4 inches in length wore the same labelled length size of shoe. While this could form the basis for an interesting study of shoe size in relation to foot size, it had little practical value for the problem of scheduling sizes of boots and inserts.

Electrically Heated Footgear: The work of size testing and scheduling unfortunately repeats the pattern outlined above for electrically heated clothing. The F-2 insert was scheduled on the basis of design specifications for size coverage alone since, at the time, production was being expedited. Several months later two independently conducted size tests proved that the inserts were fitting larger feet than the design specifications call for, and a rescheduling was necessary. Toward the end of production, routine size check of manufacturers which had just been initiated picked up a design construction fault which caused the toe of the insert to buckle inward effectively reducing the size of foot comfortably accommodated. This is again a case in which early haste in production caused later delay in procurements and, consequently, issue.

Q-1 Electrically Heated Insert: The primary scheduling of this overshoe was made on the basis of experimental samples without wiring installed. These samples were assured to be exact models of the production inserts. However, the first size test of actual production inserts revealed that the experimental samples were a good half size larger. Change in procurement scheduling was necessary. This taught a further lesson of procedure in size analysis: never permit any item to be used in size test as a basis for procurement scheduling unless it is a production model or the equivalent. The use of design specifications and experimental samples for analysis of size coverage both have proved to be misleading.

A-9 Flying Boot: Items of clothing already out of production can also be of importance for sizing work and should be carefully checked for adequacy before re-issue as evidenced by the A-9 overshoe. This boot was discontinued before the program of size analysis was initiated. However, surpluses of all sizes were available in stock, and it was thought that these could be issued for wear over the high top GI shoe as a lighter weight substitute for the A-6 and A-6A shearling boot. A light weight boot was desired in the Pacific theater.

**SHOE SIZE DISTRIBUTION — FIGHTER PILOTS
IN PERCENTAGES**

BREADTH

SIZE	AAA	AA	A	B	C	D	E	EE	EEE	FIGHTER
5										
5 1/2						0.32		0.32		0.64
6						1.28	0.32			1.60
6 1/2				0.32	1.92	1.60	0.32	0.64		4.80
7				0.96	1.29	2.89	0.64			5.78
7 1/2			0.32	0.32	1.92	7.07				9.63
8				0.64	3.21	5.14	1.92	0.32		11.23
8 1/2				2.25	7.40	6.75	0.96			17.36
9			0.96	0.64	5.79	5.14	0.96			13.49
9 1/2		0.64	0.64	2.89	5.49	8.03	0.32			18.01
10			0.32	1.61	3.53	1.61				7.07
10 1/2				1.61	1.28	2.56	0.32			5.77
11			0.96	0.64	0.32	0.64				2.56
11 1/2			0.32		0.32	0.64				1.28
12			0.32			0.32				0.64
12 1/2										
13										
13 1/2										
14										
14 1/2										
		0.64	3.84	11.88	32.47	43.99	5.76	1.28		99.86

4383-C-AML

Figure III, 28

SHOE SIZE DISTRIBUTION - BOMBARDMENT
RATIO 4 HEAVY: 1 MEDIUM
IN PERCENTAGES

BREADTH

SIZE	AAA	AA	A	B	C	D	E	EE	EEE	BOMBARDMENT
5					0.10					0.10
5 1/2					0.11	0.10	0.10			0.31
6					0.20	0.72	0.31			1.23
6 1/2			0.11		0.10	1.13	0.41	0.11		1.86
7				0.31	1.03	2.20	1.26	0.52		5.32
7 1/2				0.52	1.56	3.05	0.41	0.41		5.95
8			0.20	0.72	3.32	4.58	1.48	0.72		11.02
8 1/2			0.31	1.99	4.16	7.38	1.13	0.93	0.11	16.01
9			1.16	1.89	5.19	5.51	1.67	0.31		15.73
9 1/2		0.10	0.11	1.78	5.30	6.21	1.34	0.11		14.95
10			0.61	2.61	3.34	4.67	0.62	0.20		12.05
10 1/2	0.10		0.83	1.03	2.43	2.38	0.72	0.20		7.69
11		0.10	0.31	0.72	1.65	1.03	0.40			4.21
11 1/2			0.42	0.51	0.82	0.41				2.16
12	0.11			0.30	0.40	0.10				0.91
12 1/2		0.11		0.10						0.21
13										
13 1/2										
14										
14 1/2	0.10									0.10
	0.31	0.31	4.06	12.48	29.71	39.47	9.85	3.51	0.11	99.81

4383-E-AML

Figure III, 29.

**SHOE SIZE DISTRIBUTION-TOTAL ISSUE
RATIO I FIGHTER PILOT : 9.2 TOTAL BOMBARDMENT
IN PERCENTAGES**

BREADTH

SIZE	AAA	AA	A	B	C	D	E	EE	EEE	
5					0.05					0.05
5 1/2					0.06	0.21	0.05	0.16		0.48
6					0.10	1.00	0.32			1.42
6 1/2			0.06	0.16	1.01	1.36	0.36	0.38		3.33
7				0.64	1.16	2.54	0.95	0.26		5.55
7 1/2			0.16	0.42	1.74	5.06	0.20	0.20		7.78
8			0.10	0.68	3.26	4.86	1.70	0.52		11.12
8 1/2			0.16	2.12	5.78	7.06	1.04	0.46	0.06	16.68
9			1.06	1.26	5.49	5.32	1.32	0.16		14.61
9 1/2		0.37	0.38	2.34	5.40	7.12	0.83	0.06		16.50
10			0.46	2.11	3.44	3.14	0.31	0.10		9.56
10 1/2	0.05		0.42	1.32	1.86	2.47	0.52	0.10		6.74
11		0.05	0.64	0.68	0.98	0.84	0.20			3.39
11 1/2			0.37	0.26	0.57	0.52				1.72
12	0.06		0.16	0.15	0.20	0.21				0.78
12 1/2		0.06		0.05						0.11
13										
13 1/2										
14										
14 1/2	0.05									0.05
	0.16	0.48	3.97	12.19	31.10	41.71	7.80	2.40	0.06	99.87

4383- AML

Figure III, 30.

**SHOE LENGTH AND WIDTH
VERY HEAVY BOMBARDMENT**

LENGTH	WIDTH								
	AA	A	B	C	D	E	EE	EEE	
5				.176					.176
5 1/2							.176	.176	.352
6						.528			.528
6 1/2					1.408	.704	.176		2.288
7				1.584	1.408	1.408	.176		4.576
7 1/2		.352	.176	2.112	4.577	.528	.176		7.921
8	.176	.176	1.408	3.345	4.577	.528	.352		10.562
8 1/2	.352	.352	2.288	3.873	6.514	1.408	.704		15.491
9		.352	2.816	5.809	5.281	1.232			15.490
9 1/2		.528	3.169	4.753	6.161	.704	.704		16.019
10		.704	1.760	4.049	2.992	.704			10.209
10 1/2	.176		1.584	3.345	2.288	.528	.176		8.097
11	.352	.528	.704	.880	1.056	.528			4.048
11 1/2			.704	.352	1.056	.352			2.464
12		.176	.352	.880	.176				1.584
12 1/2					.176				.176
13									
13 1/2									
14									
14 1/2									
	1.056	3.168	14.961	31.158	37.670	9.152	2.640	.176	99.981

43918 AML

Figure III, 21.

The four sizes of A-9 overshoe were examined with a view to adaptation for this purpose, and it was found that approximately 83% of men could be accommodated wearing the GI shoe under it. If the Q-1 electrically heated overshoe were worn also, the percent accommodated was reduced to 50. But this was not all of the story. A serious difficulty arose from the fact that the A-9 overshoe was never meant to be worn with conventional type foot gear. Since it was originally built for use with the F-1, and F-2 types of insert, the sole was constructed with an arch support and raised heel to supply the features of conventional foot support. When the GI shoe was superimposed upon this formed sole, the heel of the foot was raised as much as 2 1/4 inches above the floor. In addition, the built-in arch support caused the foot to roll outward to the side. Most subjects objected strenuously to this feeling and said that they would not want to wear the boot if anything else were available. In the light of these facts, recommendation was made that the overshoe not be used, but that if there were a requirement for a lighter boot, it should be developed for specific size coverages and functional conditions.

A-6 Shearling Boot: Following the lead of the A-9 overshoe, the A-6 boot was initially procured in four sizes with no check to determine what ranges of shoe size these accommodated. Thus when wearing of the high top GI shoe for flights became a requirement in most theaters of operations and later still, when the Q-1 insert was designed to cover this shoe, additional sizes, (XX-L, XXX-L) had to be procured. Routine size checking of samples drawn from manufacturers' production was done with GI shoes representing top size for accommodation as indicated on the label. Due to the start on an inadequate number of sizes, the larger sizes of the boot remained a critical production item.

SUMMARY AND CONCLUSIONS

It cannot be stated definitely how successful the size control program was from the standpoint of issue, for the means of checking it through on every item with which it was concerned were not available. In those few cases where circumstances were favorable and some check was possible (e. g. helmets), the results were very encouraging.

At its inception the program was faced with the task of bringing some uniformity into a number of types of clothing badly needed for issue, made according to no standard patterns and therefore not standardized as to size, with the addition that little was known about the actual size of the men to be fitted. As a result, the first attempts were of a stop-gap nature, minor changes and compromises designed to hold to a minimum interference with production. In some cases this primary obstacle was never successfully hurdled, witness electrically heated clothing and its recurring difficulties.

As new types of clothing were developed and opportunity was offered for the application of size techniques from the design stage onward, there was evidence of sharply decreasing variability both within a single manufacturer's production and between manufacturers. This holds out a prospect for more con-

trolled issue procedure, hence more reliable issue reports which can be re-applied to procurement schedules.

In the final analysis, it is felt that whatever happened in the size control program during the war is of little moment unless mistakes that have been made and difficulties encountered add up to a body of experience which can and will be applied in the future. The outline of a method culled from this experience is presented below. Some of it has already been organized and is functioning, other phases are suggestive of organization for the more efficient handling of the problem.

1. Design Control. The function of design is now and should be in the future an Army Air Force responsibility. The present organization has handled the problem well and might well carry it on in the postwar period whatever the demands on clothing.

2. Size Control. This falls into four major divisions:

a) Knowledge of the population to be fitted: This changes from time to time, and the samples drawn from it at one period, such as the present with its greatly expanded organization, cannot be applied uncritically to a later organization perhaps selected on a different basis. The personnel required for surveys of this type need not be great in number or extensively trained. Any man capable of being trained to take tailors' measurements and of accurately recording them can do the work.

But only half of the job is done when the survey is completed, for the information must be put into a useful form. The most effective way of doing this is the percentage chart which defines the population in terms of frequencies in any two dimensions (e. g. chest and sleeve, waist and inseam). These charts are so constructed that the percentages represent occurrences up to and including the number represented. Thus, thirty-six inches in chest equals the percentage of individuals with a measurement ranging from 35.1 up to and including 36 inches, not a distribution ranging from 35.5 to 36.5 inches. This is dictated by the functional design of clothing. A size 36 jacket is made to fit a man with a chest circumference of 36 inches as a top, not 35.5 to 36.5 inches.

b) Fitting trials are necessary in this procedure and must be carried out with a knowledge of the size of the population already available. This can be supplied by the percentage charts which inform the tester both what range of body size he must expect to cover and how he can most effectively spot his test subjects to cover the range.

Analysis of the fit of a garment can be accomplished by any individual who is reasonably observant and knows what the garment was designed for. This latter aspect is very important, for unless the tester is cognizant of such matters as what is to be worn under an article of clothing, under what conditions of activity will it be worn, with what other clothing must it be integrated, etc., he is not competent to conduct a valid size test.

Fitting trials should always be accomplished upon clothing which represents the final design stage so that later modifications causing an alteration of fit are ruled out. If a change is contemplated while a garment is in production, fitting trials should be conducted immediately. Experience has amply demonstrated that mere assurances that the change will not affect size are not to be depended upon and that speed of production at any price does not pay in terms of items available for issue.

c) Standardization control is essential and may be attained by cutting standard patterns from a tested master pattern. The system now functioning operates according to this plan, and the Army Air Forces should never again put itself in the position of depending upon individual manufacturers' ideas of what constitutes a size whether specified check measurements for the finished product are available or not. This old system is complicated, sloppy, and expensive.

d) Size checks are the final test of the developmental process leading from design to issue. Its functions are best maintained if they are centralized at the point where steps can be taken most effectively for corrective action. It has become obvious during the war that resident inspectors, if they are handling a procurement of any size, have more than enough to do if they properly inspect details of construction and workmanship. To burden them additionally with the duty of check measurements reduces overall efficiency.

What is needed to maintain an effective size check with respect to personnel required and their functions? This, of course, will vary with the size of the procurements but will be discussed here from the standpoint of the immediate past.

1. At least two individuals should be continually available for the routine process of check measurements, analyzing these, reporting, contacting proper agencies when corrective action is needed, and, equally important, following up to be sure that such action is taken expeditiously. Many difficulties encountered in the past can be directly attributed to a lack in this last field of activity.

2. At least one person should be available to maintain liaison with other agencies involved in the entire process from design to issue.

3. At least one person should be available on a part time basis to check Purchase Orders, Production Reports, etc., to determine the relation of procurement and production to schedules. He would also serve as an observer on all field tests of personal equipment where size function is involved.

RECOMMENDED PERCENTAGES FOR CLOTHING PROCUREMENT AND ISSUE

The following recommended procurement and issue schedulings, an excerpt from the Personal Equipment Officers' Handbook, are presented as an overall picture of the distribution of sizes of Army Air Force clothing as predicted from the surveys of body size of flying personnel. These percentages represent a sampling of the population concerned during World War II, and they should not be projected into postwar use unless a careful check survey is done to determine their validity. They can afford a basis of comparison with future issues when such data are available.

Listed below are the types of flying clothing now in production, and being issued. The ranges of dimensions to be accommodated are suggestive, not mandatory. In general, better fits will result if these ranges of measurements are followed, but individual cases will demand some deviation.

The predicted percentages for procurement and issue are based on the performance of the items with respect to the range of body dimensions and clothing worn. No other consideration enters into their calculation; therefore, they are inevitably modified by such factors as stock overages and shortages, the type of population to be fitted, issue experience, etc.

MEASUREMENTS

- Sleeve:** Subject raises arm to the side until horizontal and bends elbow until upper arm and forearm form an angle of about 60°. Measurement is taken from the middle of the back, over the point of the elbow to the wrist, (styloid process of the ulna).
- Chest:** A circumference taken as high as possible under the arms.
- Waist:** A circumference taken at the belt line just above the hip bones.
- Inseam:** Subject stands erect with feet slightly parted. Measurement taken with end of tape snug in crotch to sole of shoe where it joins the heel.

A cloth tape which has been checked for accuracy may be used for measuring. The tape must not be pulled tight in any of the measurements.

PERCENTAGE TABLES

The percentage tables presented below are derived from the general percentage distribution charts which have been discussed earlier. By testing a garment's tolerance over a variety of the population, its fit over carefully defined groups may be defined by the test, and the tables are then merely the added percentages which have fallen into one size-fit category.

K-1 and L-1 Light Flying Coverall

<u>Size</u>	<u>Stature</u>	<u>Chest</u>	<u>Predicted Percentages</u>
Small Short	60.5"-65.5"	32"-35"	3.82
* Medium Short	60.5"-65.5"	36"-39"	6.40
Small Regular	66.0"-70.5"	32"-35"	14.58
Medium Regular	66.0"-70.5"	36"-39"	47.41
Large Regular	66.0"-70.5"	40"-44"	6.62
* Medium Long	71.0"-76.5"	36"-39"	18.32
Large Long	71.0"-76.5"	40"-44"	3.80

* Men who have a chest circumference greater than 39" but stature less than 66" may take Medium Short, Medium Regular, or Large Regular, depending upon fit. Men who have a chest circumference less than 36" but stature in excess of 70.5" may take Medium Long, Small Regular, or Medium Regular.

B-15, A-11, and B-15A, A-11A Intermediate

Jacket:

<u>Size</u>	<u>Chest</u>	<u>Sleeve</u> (Ideal Accommodation)	<u>Predicted Percentages</u>
34	32"-34"	32.5"	8.0
36	35"-36"	32.5"	32.0
38	37"-38"	32.5"	39.0
40	39"-40"	33.0"	16.0
42	41"-42"	34.0"	4.0
44	43"-44"	34.0"	1.0

Trouser:

<u>Size</u>	<u>Waist</u>	<u>Inseam</u>	<u>Predicted Percentages</u>
28	26"-28"	Entire Range	5.0
30	29"-30"	Accommodated	35.0
32	31"-32"	in Each Size	42.0
34	33"-34"		14.0
36	35"-36"		3.0
38	37"-38"		1.0

F-3 and F-3A Electric Suit

Jacket:

<u>Size</u>	<u>Chest</u>	<u>Sleeve</u>	<u>Predicted Percentages</u>
Small Regular	32"-35"	Entire Range	20.0
Medium Regular	36"-39"	Sleeve Length	66.0
Large Regular	40"-44"	Accommodated	14.0

F-3 and F-3A Electric Suit Continued

Trouser:

<u>Size</u>	<u>Waist</u>	<u>Inseam</u>	<u>Predicted Percentages</u>
Small Regular	26"-30"	27"-31"	16.0
Medium Regular	31"-34"	27"-31"	35.0
Large Regular	35"-38"	Entire Range	5.0
Small Long	26"-30"	32"-36"	23.0
Medium Long	31"-34"	32"-36"	21.0

Gloves

<u>Size</u>	<u>A-11A</u>	<u>F-2</u>	<u>B-3</u>	<u>D-3</u>
8 - Small	8.0%	8.0%	20.0%	5.0%
9 - Medium	45.0%	45.0%	35.0%	25.0%
10- Large	35.0%	35.0%	35.0%	75.0%
11- Extra-large	12.0%	12.0%	10.0%	

A-6 Heavy Boot

<u>Size</u>	<u>Shoe Size</u>	<u>Predicted Percentages</u>
Small	4 1/2 - 5 1/2	1.0
Medium	6 - 7	10.0
Large	7 1/2 - 8 1/2	35.0
Extra Large	9 - 10	41.0
XX- Large	10 1/2 - 11 1/2	12.0
XXX- Large	12 - 13	1.0

Q-1 Oversock Insert

<u>Size</u>	<u>Shoe Size</u>	<u>Predicted Percentages</u>
Small	5 1/2 - 7	8.82
Medium	7 1/2 - 8 1/2	32.98
Large	9 - 10	42.73
X- Large	10 1/2 - 11 1/2	14.06
XX- Large	12 - 13	1.22

WOMEN'S FLYING CLOTHING

At the time that the Women Army Service Pilot (WASP) organization was activated and the number of Flight Nurses trained by the School of Air Evacuation was increasing rapidly, it was decided to obtain basic body size data on samples drawn from these groups. Standards for selection had already been established along the lines of height, weight, and age, but the frequencies and distributions within the groups were not known. Many problems connected with use of female personnel in the Army Air Forces could be anticipated and clothing requirements were not the least of these.

It was not known to what extent these female specialists would be employed, and, rather than wait until that time when the lack of such data had become an obstacle to the accomplishment of these programs, surveys were undertaken immediately. Head, face, hand, and body measurements were taken on 447 women pilot trainees and on 152 flying nurses. Helmet and oxygen mask sizes were calculated from the head and face measurements and made available; see page 25, and Figure III, 12, page 29. Size test of gloves was carried out, using subjects in the same manner as that outlined for the male population, and percentage charts, Figures III, 32; III, 34; III, 35; III, 36; III, 37; III, 38; and III, 39, were compiled for clothing size testing. Details of clothing size to cover the range of body size were worked out and communicated to the responsible agencies. Also for a period of time two WASP's were assigned to the testing of various clothing outfits under flight conditions.

Later the WASP program was discontinued and the sizes permitted for Flight Nurses increased almost to the limits previously permitted for WASP's. This fact made the WASP data still applicable. Work was carried on in the sizing of nurses' uniforms and other clothing, but procurements were small and this never became a major activity.

RECOMMENDED PERCENTAGES FOR WOMEN'S FLYING CLOTHING

Restrictions regarding size requirements for nurses in this category have been changed to permit sizes up to six feet tall and one hundred and sixty-five pounds in weight. For this reason two schedules, "light" nurses (up to 135 lbs.) and "heavy" nurses (up to 165 lbs.) have been determined.)

Size	JACKET		SUITS: L-1 and K-1		
	"Light" %	"Heavy" %	Size	"Light" %	"Heavy" %
12	30.0	13.0	24	22.0	12.0
14	44.0	41.0	26	43.0	31.0
16	17.0	28.0	28	28.0	41.0
18	7.0	14.0	30	5.0	13.0
40	2.0	3.0	32	2.0	2.0
42		1.0	34		1.0

CAPS

<u>Size</u>	<u>"Light"</u> <u>1/2 Sizes %</u>	<u>"Heavy"</u> <u>1/2 Sizes %</u>
20	2.0	1.0
20 1/2	8.0	7.0
21	32.0	25.0
21 1/2	41.0	31.0
22	12.0	26.0
22 1/2	4.0	8.0
23	1.0	2.0

GLOVES

<u>Size</u>	B-3A		A-11A	
	<u>"Light" %</u>	<u>"Heavy" %</u>	<u>"Light" %</u>	<u>"Heavy" %</u>
6 1/2	22.0	29.0		
7	33.0	37.0	29.0	22.0
7 1/2	30.0	23.0	47.0	42.0
8	15.0	11.0	18.0	25.0
8 1/2			6.0	11.0

ARM LENGTH AND CHEST CIRCUMFERENCE WASP
PERCENTAGES

ARM LENGTH (CM.)	CHEST (IN.)														
	30	31	32	33	34	35	36	37	38	39	40	41	42	43	
65.5						0.45									0.45
66.3					0.45		0.22	0.22	0.22						1.11
67.1				0.22		0.45	0.22								0.89
67.9		0.22	0.22	0.22	0.90		0.22	0.22	0.22						2.22
68.7	0.22		0.22	1.12		0.22	0.22	0.22	0.45	0.22					2.89
69.5		0.90	0.45	1.12	1.57	1.12	1.79	0.67							7.62
70.3	0.22	0.22	1.12	1.57	1.35	2.47	0.67	1.12	0.45	0.22					9.41
71.1			0.67	0.67	1.79	2.02	2.02	0.22	0.22	0.90					8.51
71.9		0.45	0.22	1.35	1.35	2.69	1.35	1.12		0.45	0.22			0.22	9.42
72.7		0.22	0.45	1.57	1.12	1.79	2.02	1.57	0.45	0.67	0.22	0.22			10.30
73.5			0.45	1.35	1.57	2.91	1.35	0.45	0.45		0.67	0.22			9.42
74.3			0.67	0.67	2.24	1.35	1.57	2.24	0.90	0.45	0.22				10.31
75.1		0.22		1.12	2.02	1.12	1.35	1.35	1.12	0.67	0.45	0.22			9.64
75.9				0.45	0.90	0.90	1.35	1.35	0.22	0.67					5.84
76.7				0.22	0.45	0.45	1.12	0.67	0.90		0.45				4.26
77.5			0.22	0.45	0.22	0.22	0.90	0.45	0.90			0.22			3.58
78.3					0.45	0.67	0.22		0.22						1.56
79.1						0.22	0.67	0.22							1.11
79.9						0.45	0.22		0.22			0.22			1.11
80.7					0.22		0.22								0.44
81.5									0.22						0.22
	0.44	2.23	4.69	12.10	16.60	19.50	17.70	12.09	7.16	4.25	2.23	1.10		0.22	100.31

4391C AML

Figure III, 32.

ARM LENGTH AND CHEST FLYING NURSES
PERCENTAGES

ARM LENGTH (CM)	CHEST (IN.)													
	30	31	32	33	34	35	36	37	38	39	40	41	42	43
65.5						0.66								0.66
66.3			1.97				0.66							2.63
67.1		0.66			1.32									1.98
67.9			0.66		1.32		0.66							2.64
68.7			0.66	2.63	0.66	1.32	1.32		0.66					7.25
69.5			1.32	1.97	1.32	0.66	0.66							5.93
70.3			0.66	1.97	3.95	1.97	1.32	0.66	0.66	1.32				12.51
71.1			1.32		3.29	2.63		0.66	0.66					8.56
71.9			1.97	1.32	2.63	1.32	0.66	1.32		0.66				9.88
72.7		0.66	1.32	1.97	2.63	3.29	1.97	1.97						13.81
73.5				1.32	3.95	3.29	2.63	0.66						11.85
74.3				1.97	1.97		0.66							4.60
75.1				0.66	1.32	1.32	1.32	1.32						5.94
75.9				0.66	0.66									1.32
76.7				1.97		0.66	1.32		0.66					4.61
77.5							0.66							0.66
78.3					0.66	0.66	0.66	0.66						2.64
79.1														
79.9														
80.7						0.66								00.66
81.5				0.66										00.66
		1.32	9.88	17.10	25.68	18.44	14.50	7.25	2.64	1.98				98.79

4391J AML

Figure III, 33.

WAIST HEIGHT AND WAIST WASP
PERCENTAGES

WAIST HEIGHT (CM.)	WAIST (IN.)															
	23	24	25	26	27	28	29	30	31	32	33	34	35	36		
91.9																
92.9																
93.9																
94.9	0.23	0.23	0.45	0.68	0.23											1.82
95.9			0.90	0.45						0.23						1.58
96.9		0.23	0.90	0.45	0.23	0.23										2.04
97.9	0.68	0.23	0.90	1.80	0.90		0.23									4.74
98.9		1.35	1.13	0.90	0.90		0.45	0.23								4.96
99.9		0.90	0.68	1.35	0.68	0.68	0.68	0.23								5.20
100.9	0.23	0.90	2.03	2.93	0.68	0.68										7.45
101.9	0.45	1.35	2.48	2.48	2.25	1.80	0.23	0.45	0.23	0.23						11.95
102.9	0.23	0.45	2.48	2.48	1.13	0.90	0.68	0.23		0.23						8.81
103.9		1.35	1.80	1.58	2.93	0.45	1.13	0.68	0.23	0.23						10.38
104.9		1.35	0.68	2.25	1.58	1.35	0.90	0.45		0.45						9.01
105.9		0.23	0.45	2.03	1.35	2.93	0.23	0.23	0.23							7.68
106.9		0.23	0.23	1.58	1.80	2.03	1.13	0.68	0.23	0.23						8.14
107.9			0.23	1.13	0.23	0.90	0.45	0.23	0.23							3.40
108.9			0.90	1.80	0.68	1.35	0.68	0.45	0.45							6.31
109.9			0.23	0.23	1.58	0.68			0.23							2.95
110.9			0.45	0.23	0.45	0.68	0.23									2.04
111.9					0.23		0.23									0.46
112.9		0.23														0.23
113.9																
114.9																
115.9				0.23	0.23											0.46
116.9					0.23											0.23
117.9								0.23								0.23
	1.82	9.03	16.92	24.58	18.29	14.66	7.25	4.09	1.83	1.60						100.07

4391 AML

Figure III, 34

WAIST HEIGHT AND WAIST FLYING NURSES
PERCENTAGES

WAIST HEIGHT (CM.)	WAIST (IN.)															
	23	24	25	26	27	28	29	30	31	32	33	34	35	36		
91.9				0.66											0.66	
92.9				0.66											0.66	
93.9				0.66											0.66	
94.9			1.32	0.66		0.66		0.66							3.30	
95.9		0.66		1.32		0.66									2.64	
96.9	0.66		1.99		0.66	0.66									3.97	
97.9		0.66	2.65	1.32	3.31	0.66		0.66							9.26	
98.9		0.66	0.66	3.97	1.32	1.32									7.93	
99.9		0.66	0.66	3.97	1.99	1.99									9.27	
100.9	0.66	0.66	0.66	0.66	1.99	2.65	0.66								7.94	
101.9		1.32	1.99	1.32	1.32	0.66					0.66				7.27	
102.9		1.32	1.32	3.97	2.65	1.99	0.66								11.91	
103.9		1.99	2.65	3.31	1.99	1.99									11.93	
104.9		0.66	0.66	3.31	2.65			0.66							7.94	
105.9			1.32	1.32	1.32										3.96	
106.9			0.66	0.66		0.66									1.98	
107.9		0.66	0.66		0.66										1.98	
108.9					0.66		0.66								1.32	
109.9			1.32	0.66	1.99			0.66							4.63	
110.9																
111.9																
112.9																
113.9				0.66											0.66	
114.9																
115.9																
116.9																
117.9																
	1.32	9.25	18.52	29.09	22.51	13.90	1.98	2.64			0.66				99.87	

4391H AML

Figure 10, 35.

WAIST HEIGHT AND HIP CIRCUMFERENCE WASP
PERCENTAGES

WAIST HEIGHT (CM.)	HIP CIRCUMFERENCE (IN.)															
	31	32	33	34	35	36	37	38	39	40	41	42	43	44	45	
92.9																
93.9																
94.9					0.44	0.22	0.44	0.22	0.22						1.54	
95.9					0.44	0.22	0.22	0.44			0.22				1.54	
96.9					0.44	0.22	0.22	0.67		0.44					1.97	
97.9				0.44	0.44	1.55	1.33	0.67		0.22			0.22		4.87	
98.9				0.44	0.22	0.67	0.22	1.77	1.33	0.22					4.87	
99.9				0.22	0.67	0.67	0.89	0.89	0.89	0.44	0.22		0.22		5.11	
100.9				0.22	0.44	1.11	1.55	1.77	1.33	1.33					7.75	
101.9			0.22	0.44	0.44	1.55	1.77	2.44	1.77	1.33	0.89	0.22	0.22	0.22	0.22	11.73
102.9		0.22		0.22	0.22	1.33	0.89	0.67	2.00	2.00	0.22	0.22		0.44	8.43	
103.9					0.67	1.33	2.00	1.33	1.55	1.55	1.11	0.44	0.44		10.42	
104.9					0.22	0.44	2.22	1.33	2.00	1.11	0.44	0.67	0.44		8.87	
105.9						0.22	0.89	1.77	0.89	2.66	0.89		0.44		7.76	
106.9						0.44	0.44	1.55	1.77	1.33	1.11	0.22	0.67		7.53	
107.9							0.22	1.11	0.67	0.67	0.22	0.44	0.44		3.77	
108.9					0.22	0.22	1.11	0.89	0.89	0.89	0.89		0.67		0.22	6.00
109.9							0.89	1.11	0.44		0.22	0.22	0.22			3.10
110.9							0.22	0.67	0.44	0.44	0.22		0.22		0.22	2.43
111.9							0.22		0.22							0.44
112.9					0.22						0.22					0.44
113.9																
114.9																
115.9								0.22			0.22	0.22				0.66
116.9															0.22	0.22
117.9																
		0.22	0.22	1.98	5.08	10.19	15.74	19.52	16.41	14.63	7.09	2.65	4.20	0.66	0.88	99.47

4391E AML

Figure III, 36.

WAIST HEIGHT AND HIP CIRCUMFERENCE FLYING NURSES
PERCENTAGES

WAIST HEIGHT (CM.)	HIP CIRCUMFERENCE (IN.)														
	31	32	33	34	35	36	37	38	39	40	41	42	43	44	45
91.9					0.66										0.66
92.9						0.66									0.66
93.9									0.66						0.66
94.9					0.66	0.66	0.66	0.66	0.66						3.30
95.9							1.97								1.97
96.9						1.32	0.66	1.32	0.66						3.96
97.9						2.63	3.29	1.97	0.66						8.55
98.9					1.32	0.66	3.95	1.97							7.90
99.9				0.66	0.66	1.97	1.97	3.97	1.32						9.87
100.9						0.66	3.95	1.97			1.32				7.90
101.9						1.97	1.97	1.32			1.32				6.58
102.9					1.97	0.66	2.63	2.63	0.66	3.29					11.84
103.9			0.66				3.29	3.95	3.29	0.66					11.85
104.9				0.66		1.32	1.97	0.66	2.63		0.66				7.90
105.9						0.66	1.97	0.66	0.66	0.66					4.61
106.9							1.32								1.32
107.9					0.66	0.66		1.32							2.64
108.9								0.66			0.66				1.32
109.9						0.66		1.97	1.32	0.66					4.61
110.9															
111.9															
112.9															
113.9									0.66						0.66
114.9															
115.9															
116.9															
117.9															
			0.66	1.32	5.93	14.45	2.63	2.43	3.18	5.27	3.96				98.76

4391A AML

Figure III, 37.

The data and percentages presented represent only tentative data. Any new female clothing will necessarily entail much more complete data. Data collected on WAC and Nurse Corps will probably be more valuable for initial design, inasmuch as they will offer much more detailed information concerning the shoulders and bust.

FLAK CLOTHING

Flak-protective clothing, designed to protect vital regions of the flyer's body against small, low-velocity missiles, consists of helmets and body armor (flak suits). Anthropometric participation in the design and development of flak helmets originated in connection with the integration of personal equipment and turrets, and is therefore outlined in the section on turrets.

The chief problems posed by body armor have been those of integration with other items of personal equipment, rather than with airplane or turret design, probably because flak suits combine simplicity of design with a minimum of bulk. They add weight to the flyer -- a weight which, in the face of adverse flak conditions, he has been more than willing to tolerate, but aggravate problems of cramping and constriction to a relatively small degree. The first anthropometric project on flak suits was to secure adoption of a tab on the front of the vest, to serve as an attachment for the oxygen mask hose clip, for which no provision had previously existed. A second project began early in 1944 with a verbal request from the Air Surgeon to investigate possibilities of improving coverage in the armpit region, where flak wounds had resulted in a number of casualties. Trials of flak suits over the flyer's complete set of personal equipment -- heavy clothing, life vest, emergency kit, and parachute -- showed that not only the armpit region, but considerable areas along the sides, varying in extent with the flyer's size, were left unprotected when front and back portions of the suit failed to meet.

In cooperation with Brig. Gen. M. C. Grow, originator of Army Air Force body armor, and with British manufacturers, experimental side pieces were devised, combat tested in the 8th Air Force, and proved successful. However, Headquarters, Army Air Forces, decided that no more weight could be added to existing armor, and the side extensions were therefore not standardized.

Toward the end of the War, a new model of flak suit, substituting aluminum for Hadfield steel plates and providing a greater area of protection for less weight, was developed by the Ordnance Department. The necessity for considering all the flyer's personal equipment in its design was pointed out by the Aero Medical and Personal Equipment Laboratories, and the version finally standardized furnished adequate coverage for a large man in full gear. Although the possibility of producing different sizes of body armor, to provide for differences in flyer's body sizes, seemed attractive from time to time, it was never seriously contemplated, for two main reasons: (1) the inordinate complications in production and distribution that different sizes would entail; and (2) as shown by the T-46 flak suit, enough coverage could be designed into the suit to accommodate large flyers and not inconvenience small ones.

Administratively, the Ordnance Department was responsible for the design and manufacture of flak-protective equipment for the entire war, while the informal advisory role of the Air Technical Service Command as far as design and integration with other flying equipment were concerned ultimately evolved into

an official board, with a representative of the Personal Equipment Laboratory (as the responsible agency of the Engineering Division) as chairman, and representatives of the Aero Medical Laboratory, Armament Laboratory, and the Ordnance Office, Air Technical Service Command, as members. This Board processed Unsatisfactory Reports on body armor design, new ideas, and experimental outfits, and forwarded recommendations to the Ordnance Department.

PARACHUTES

The part played by Anthropometry in design, development, and supply of parachutes is two-fold: (1) distribution of body sizes, and (2) distribution of body weights.

The harness can be greatly improved if provision can be made for adequate adjustments to accommodate the various flyer's body sizes, and could be further improved if actual sizing could be introduced into harnesses. During World War II, small steps were taken in this regard and appeared promising. A table, Figure III 39, to show the distribution of statures and waists, could serve well to predict, with the clothing factors known, the sizing system for harness, just as the tables mentioned earlier served for clothing size distributions.

Since various size parachutes act in proportion to the weights of the men which they must support, a proportion distribution of the weights selected for best behaviour of the sizes of parachutes could easily be prepared and provided.

The final role of the anthropologist in the consideration of the parachute, as in all other items of equipment, is one of insuring proper integration of all the equipment, and should be constantly the same for every developmental engineer.

**STATURE AND WAIST
TOTAL ISSUE**

STATURE	WAIST														
	27	28	29	30	31	32	33	34	35	36	37	38	39	40	
60															
.5				0.08										0.08	
61					0.08		0.16							0.24	
.5															
62			0.08	0.16										0.24	
.5				0.16	0.16									0.32	
63	0.08		0.08	0.16	0.16	0.16	0.16	0.03						0.83	
.5			0.08		0.03							0.08		0.19	
64			0.03	0.11	0.03			0.16						0.33	
.5	0.08		0.16	0.18	0.32	0.32								1.06	
65		0.03	0.31	0.68	0.96	0.34	0.32	0.16	0.16					2.96	
.5		0.08	0.03	0.36	0.74	0.44	0.47		0.16					2.28	
66		0.03	0.24	0.32	0.23	0.32	0.39							1.53	
.5		0.23	0.45	1.77	1.92	1.04	1.21	0.36	0.11	0.08				7.17	
67		0.03	0.32	0.87	0.83	0.42	0.28	0.28	0.16		0.08			3.27	
.5		0.26	0.61	0.63	1.29	1.07	0.74	0.28	0.24					5.12	
68		0.03	0.63	0.78	1.26	0.58	0.71	0.52	0.24					4.75	
.5	0.03	0.21	1.42	2.89	3.41	2.63	1.81	0.60	0.32	0.16	0.16			13.44	
69		0.19	0.42	1.03	1.49	1.50	0.52	0.66		0.08	0.08		0.08	6.05	
.5		0.36	0.68	0.66	2.66	1.42	1.36	0.52	0.23	0.08				7.97	
70		0.10	0.65	1.42	2.22	2.08	0.87	0.91	0.24	0.16				8.65	
.5		0.32	0.74	1.75	2.34	2.42	2.45	1.33	0.31	0.11	0.16			11.93	
71			0.28	0.99	1.40	1.30	1.13	0.28	0.24	0.16	0.08		0.08	5.94	
.5			0.03	0.48	0.87	1.45	0.55	0.16	0.28	0.08		0.16		4.06	
72			0.19	0.42	0.78	1.89	0.94	0.16	0.50	0.19	0.16			5.23	
.5				0.11	0.49	0.55	0.65	0.11	0.03	0.11	0.16			2.21	
73			0.08	0.08	0.76	0.16	0.16	0.16	0.03					1.43	
.5			0.16	0.16	0.16	0.32	0.19		0.16					1.15	
74				0.08	0.08	0.16	0.32		0.24	0.16	0.08			1.12	
.5					0.24	0.19								0.43	
75															
.5				0.08										0.08	
76					0.08			0.08						0.16	
.5						0.08								0.08	
	0.19	1.87	7.67	16.21	24.99	20.84	15.39	6.76	3.65	1.37	0.96	0.24	0.08	0.08	100.30

4420 AML

Figure III, 38.

CHAPTER IV

AIRCREW POSITIONING

PRINCIPLES OF COCKPIT SEATING

Stick Type Control

Seating in aircraft has never been given the serious consideration it deserves because human adaptability has always been taken for granted. This is understandable, in view of the fact that, until very recently, human beings have never been required to fly for long periods of time. A fighter type aircraft, according to the definition contained in the Handbook of Instructions for Aircraft Designers, is a single-place aircraft with a range of approximately two hours. The demands of global warfare imposed upon us are such that fighter airplanes must have a range far in excess of two hours, and as long as war embraces the great distances that it does, and until the speed of all aircraft increases to the extent where time intervals decrease, this condition will remain.

It is reasonable to assume that, before a pilot or any individual can be made comfortable and efficient over a long period of time, certain mechanical provisions must be made.

Some effort has been made to develop seats which are to function in a comfortable manner through the means of contouring, but individual variations in the respective posteriors of human beings are sufficient in degree as to render this method unsuccessful for any extended period of time. Very likely, it will turn out that in addition to a range of contours, it will be necessary to cover the seat with some sort of resilient material which will compensate for any slight variations from that particular size.

In order to study the fundamentals of comfortable cockpit seating, there was made available to the Air Technical Service Command, through the courtesy of the Murray Corporation of America, the so-called Universal Test Seat, which is a piece of laboratory apparatus designed by a group of automotive engineers at the University of Michigan for studying seating requirements in automobiles. The original was loaned this Command by the Murray Corporation, and a copy was made of it, incorporating certain modifications which were adapted to the study of seating in aircraft.

The device consists of an adjustable chair, Figure IV, 1, mounted on a screw jack so that it may be adjusted vertically. Included in its construction are five adjustments: first, an adjustment for varying the seat depth, that is the distance from the front edge of the seat to a point of intersection between the seat and the back; second, one for varying the angle between the seat portion and the horizontal; third, one for varying the angle between the back of the seat and the vertical; fourth, one for varying the fore and aft position of the chair; and fifth, an adjustment for varying the height of the back with relation to the seat portion. There are appropriate scales which indicate the amount and degree of each adjustment. The seating surface consists of a light fabric, a thin cushioning pad, and a series of cylindrical coil springs. In the seat portion there are 42 of these springs, each one of which is acted upon by 9 square inches of seating area. In the back there are

Figure IV, 1.

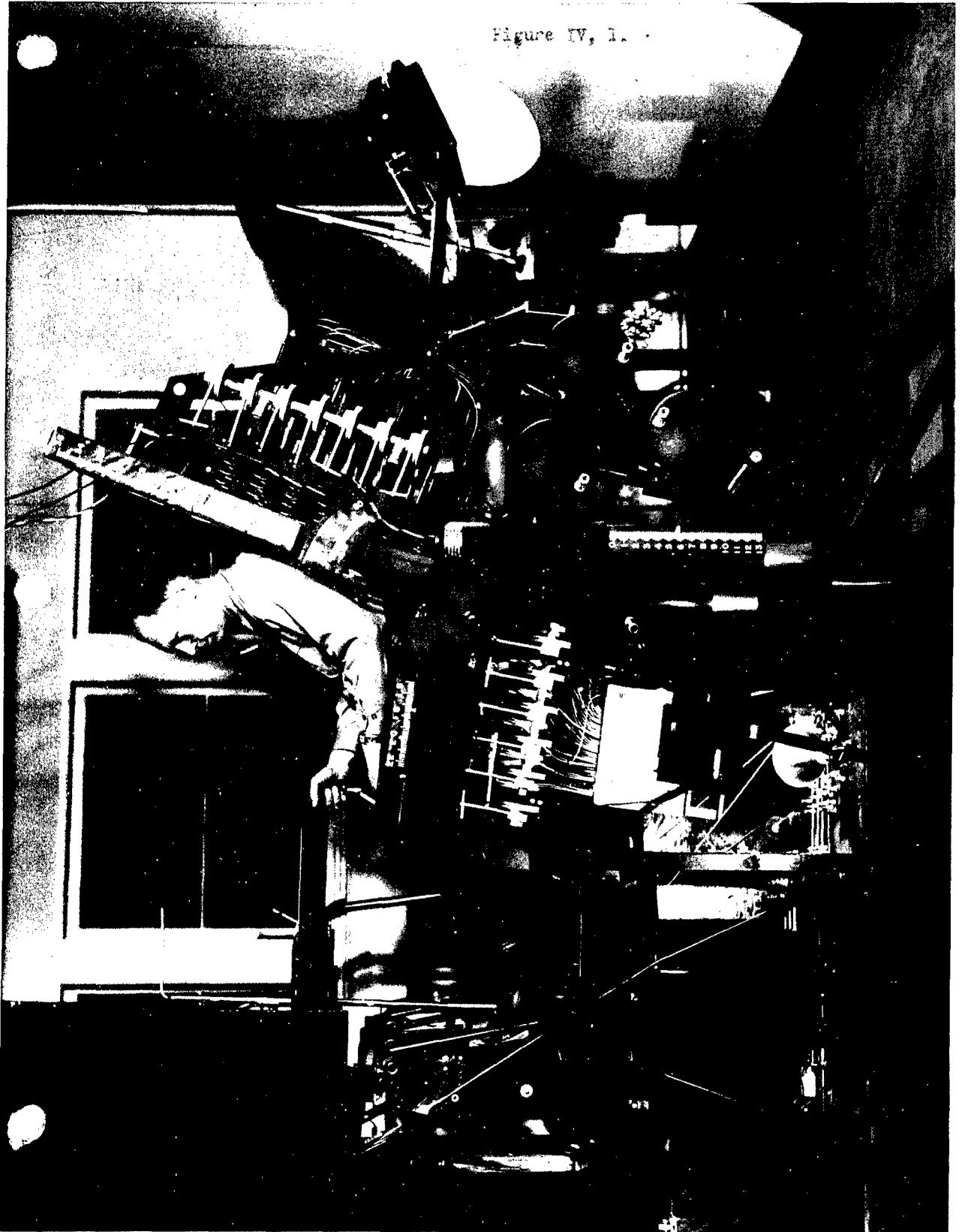

49 springs, each similarly representing 9 square inches of seating area. From the center point of attachment of each spring to the seating area there is attached a nylon cord which is let down through guides to a chart. This chart is calibrated in inches and serves as a means of recording the amount of compression of any individual spring. This is done by means of a white mark placed on each string at a point calibrated as zero on the chart when no one is sitting on the seat. Also incorporated in the seat are adjustments for varying the amount of spring compression in any tier of 7 springs.

For the purposes of studying seating in aircraft, it was found to be advisable to establish some sort of relationship between this chair and an airplane cockpit. This was done by means of constructing a set of aircraft controls which were mounted in front of the test seat. A considerable adjustment was incorporated in the controls to the extent that there were 4 inches fore and aft in the rudder pedals and there were 13 inches fore and aft and 4 inches vertically in the control column. In addition, fore and aft adjustment was added through the seat adjustment.

Still another piece of equipment was used in conjunction with the above apparatus. This was a stationary pre-flight trainer designated as the Beindorf Trainer, Model B, which is a device for visually simulating flight on the ground. It consists, essentially, of a sphere on which is painted landscape, horizon, and sky.

A battery of lights whose rays reflect over the top of the sphere and transmit by a magnifying lens the reflection of the surface to a translucent screen facing the operator is utilized. A system of pulleys and cables is connected to the control column and rudder pedals of the cockpit on one end, and to three small electric motors on the other. Each of these motors rides freely on a universal, its orientation being controlled by the afore-mentioned cables. There is a flat disc of plastic on the shaft of each motor on which the sphere rests. When the controls are in a neutral position, the sphere rests on the center point of rotation of each of these bearing discs and thus does not revolve to shift their point of contact on the sphere from the control axis, and thus causes the freely floating sphere to rotate in a direction determined by the coordinated movement of the controls.

In this particular experiment, the Beindorf Trainer served the purpose of maintaining the subject in a working attitude; that is to say, a state wherein he was going through essentially the same movements as a pilot is when flying an airplane. It is important to maintain such a state during investigations of this sort, since the purpose involved is to study pilot seating with the end of determining a basic design of adjustment for aircraft seats. Pilot seats are working seats, and should be designed for the specific job. A seat should promote both pilot comfort and efficiency. That the two are intimately correlated there is little doubt.

It must be realized and appreciated what a difficult problem it is, in the

absence of reliable objective means of measuring efficiency, to determine what form of seat and what angle of seat, also what arrangement of controls, are the most conducive to comfort and efficiency. In view of this, experienced pilots should always be used as subjects.

The general conception in the past of the structural arrangement of a cockpit has been of such a nature as to permit the use of certain items of standard equipment located according to the desires of the manufacturer and/or the responsible Army Air Forces personnel without due regard to the fact that structures in cockpits have certain functions which they should perform, and which they will not perform if they are removed from certain relationships with other portions of the equipment. For example, there has been in use for some time a standard specified bucket-type seat which manufacturers have been asked to install in the various fighter type aircraft. This seat is very specifically defined, and a point in space is also defined so as to lie in a mid-line position 2" in front of the back and 5" above the bottom of the seat. Manufacturers have been required to define the cockpit from this point. This is easily done, and it so appears on all inboard profile drawings of the cockpit.

If used as defined, and if properly installed in the aircraft cockpit, this reference point is a valuable instrument. However, there has been little regard paid to the construction and use of items of personal equipment with which the pilot must operationally be concerned, and the functional end product is a great variety of levels at which the pilot is held seated on his personal equipment, all of which, except for the simple seat-type parachute and back pad, will contribute more or less to a mal-function of the pilot and his cockpit in flight. For example, the 5 and 2 inch distances are based upon the use of the seat type parachute and back pad. If for some reason or other the pilot is forced to use the seat type parachute, the one-man life raft, and a cushion, he may be raised as much as 5" above the original reference point. If then, a cockpit has been defined in such a manner as to locate the horizontal line of vision a vertical distance of 30-1/2" above the reference point, as originally defined, and the canopy has been designed and installed with the required 8" arc above the horizontal line of vision, the pilot has been permitted to be raised not more than 2" above the vision line, because he must maintain at least 6" for his head. He has, therefore, been forced to sit 5" higher than designed, but has available only 2" upward in which he may move and, as a result, is forced to crouch or slump in such a manner as to shorten himself effectively a total of 3" in the vertical dimension, which amounts to a required 10% decrease from his normal sitting position. Add to this an insufficient amount of vertical adjustment in the seat originally, and another 1-1/2" may be added to those 3", amounting to 4-1/2" required slump, in a tall man.

Another aspect of the seat installation has been to require the back angle to lie 13-1/2 degrees from the vertical intersecting the reference point. This angle is added to a seat angle to provide an included angle of 101 degrees, which then permits the seat itself to lie 2-1/2 degrees from the horizontal. If then, the rudder pedals are located in such a manner as to bring them closer to the reference point in the fore and aft dimension than the pilot normally

requires, the knees, of course, are lifted higher and the thighs attempt to rest upon the seat level at a greater angle, which will permit a vector of weight forces to result on a very small area of the gluteal muscles lying over the ischial tuberosities. The pilot in a very short while becomes unduly cramped in his legs and sore over the area upon which he is forced to sit, and attempts to slide the buttock area backward on the seat in an effort to gain a greater area of weight support over the thighs or at worst to obtain a different area of weight support. Since he has already been forced to crouch to foreshorten his sitting height and since he attempts to move backwards in the seat to alleviate his leg cramping, his sitting position then results in an accentuated crouched attitude. This is felt to be the deciding factor in the so-called fighting attitude of the fighter pilot.

Combat pilots interviewed on this matter will support these observations. One man was able, in the A-36, to fly in his cruise condition with his chin resting on his hand which held the control column, peering over the top of the cowling.

Another factor which has been important in the mal-function of cockpits has been the indiscriminate deviation from the $13\text{-}1/2$ degree angle of the back of the seat. Although the Handbook of Instructions for Aircraft Designers states specifically that the control column at neutral shall be $19\text{-}1/8$ inches in front of the reference point, the deviation in the angle of the back in some cases has been sufficient to move the shoulders far enough back to require a man to reach forward to hold the column at neutral. In addition, this shifting-back of the angle forces a greater strain upon the neck muscles in holding the head in a normal horizontal position looking forward. Further complications of this arrangement have been poor considerations of the throttle handle. By design, the throttle is installed in such a way that the mid-point of the quadrant is held at the same $19\text{-}1/8$ inches distance as the control column, but the normal cruise position of the throttle handle may be enough forward of the mid-quadrant position to require, again, a reaching of the pilot. It therefore becomes important that a consideration be given to cockpits as functional assemblies of equipment, including the man.

Finally, before embarking upon the variable requirements of the cockpit, there should be some discussion of the method of installation of the seat itself. It has been the common practise in fighter type aircraft to install the seat on slide tubes which lie at or about the $13\text{-}1/2$ degrees from the vertical. It has been found geometrically that a seat mounted in this manner and being raised from its neutral position $3\text{-}1/2$ " will be moved posteriorly .9 inch, and also will be moved anteriorly if lowered the same amount. This is completely contrary to the proper utilization of the variables in the sizes of men. A seat is raised to permit a shorter man to maintain visual requirements and certainly he should not be moved aft from the rudder pedals; the same holds for the accommodation of the taller man in the reverse direction. Should the seat be installed in such a manner as to be adjustable directly vertical, there would certainly be an improvement over the present condition. But, theoretically speaking, it would still be necessary to design the entire cockpit upon this basis

in such a manner that the shortest man, 5'4", permitted to use the cockpit, could reach all the necessary controls, and the situation would be increasingly difficult for any statures above the 5'4" as we get nearer the 6'1" to 6'2" presently encountered among fighter personnel.

One of the primary considerations of a cockpit appears to be, from experimental evidence, a vertical dimension from the horizontal line of vision to the lower level upon which the heels rest in flight attitudes. A deviation or a variation in this dimension of no more than one inch is sufficient to change the entire functional behaviour of the cockpit assembly. An indiscriminate design application of this distance will, if sufficient, be drastic enough in many cases to limit the performance of the aircraft far more than a minor modification, such as raising or lowering the canopy or some other deviation, because of the fact that the structural relationships will introduce fatigue and strain factors as well as "g" tolerance factors upon the pilot which will drastically cut down his potential performance. It is felt that this analysis has explained to a greater degree than any other the failure of contemporary fighter aircraft to perform fully their design functions.

There are certain limits to the dimension from the horizontal line of vision to the floor beyond which it is impractical to go. A value of less than 35" appears to be completely out of the picture because of the depth required below the man for personal equipment, and any values above 43" become increasingly bad because the man is becoming more and more vertically erect until he may reach the absurd condition of standing in the cockpit. It is for us to consider, then, the functional relationships applicable to cockpits whose distances from the horizontal line of vision to the floor vary between 35 and 43 inches.

There are certain experimental limitations which have not as yet been duly investigated and will lie in the future before the picture can be complete.

The relationship of the height of the rudder bar from the floor, of the brake pedal from the floor, and the angular relationships of their movements to the aircraft and to the human body have not been fully explained. Another factor is the mechanical efficiency which is at present involved in the length of the control column and its pivot point in relation to the control surfaces. Would it be possible, for example, to reduce the length of the control column and its motion and still obtain, by human forces or by boost, enough mechanical advantage to control the surfaces in high performance aircraft? Is it advisable, and certainly it is indicated, from the standpoint of its relationship to the man to reduce the fore and aft motion of the control column below the recommended 18"? As presently done at 18", if the neutral position of the control column is held at 19", an average man sitting in the standard cockpit and restrained by shoulder harness finds it impossible to reach full forward on the column. A distance of 19" forward of the reference point has been found experimentally to be the most comfortable one, and at the same time, it has been established that the column cannot be moved farther than 9" aft of this position in its full aft position because of the size of the man interfering with it. Inasmuch as the man cannot reach full forward, the column cannot be moved from its neutral position and we can use no more than 9" aft travel, it then becomes necessary to

limit the forward travel of the column to no more than 6" which will reduce the total travel of the column to 15" at the maximum. There has been a tendency in some designs to try to maintain the full 18" with a differential fore and aft distance and yet to maintain the aft column position in relation to the man which results in placing the neutral position of the column some distance forward of the 19" required, and service reports have indicated that this has failed because of undue strain being placed upon the arms and neck in reaching for neutral.

In view of the above, since there is no fore and aft adjustability incorporated in the control column, its neutral position must be carefully defined. With this reference established, the seat should then be installed in such a manner as to incorporate a vertical adjustment which would permit it to go forward as it goes upward, and to go aft as it comes downward, to provide for the variations in arm lengths. If we permit the rudder pedals to stay as they are at present with 4" of adjustment, it would then become necessary to design into the seat a 3" fore and aft adjustment in conjunction with the vertical adjustment. In effect then, the seat would be permitted to move along the diagonal of a rectangle 7" on the vertical side and 3" on the horizontal side, the diagonal of which would lie at 67 degrees from the horizontal. Even this would not permit full accommodation for the extreme disharmonies in sitting heights and statures, but would do far better than the standard condition. In order to get full accommodation, the seat should be free to move anywhere within the 7 by 3 inch rectangle, rather than just along its diagonal.

In analyzing some of the German Luftwaffe data, it was found that German designers were asked to incorporate 6.3" vertical adjustment in the seat with a diagonal adjustment at 75 degrees. (Figure IV, 2.) A rudder adjustment of 6.3 inches was also requested which would follow a line at 45 degrees from the horizontal. This was possible because pedal stirrups were expected (Figure IV, 3.) which would hold the feet independent of floor heel rests. However, there is a basic fallacy in the use of heel rests in rudder controls; namely, that such an arrangement forces fine rudder control to be obtained by movement of the entire leg, and thus becomes extremely tiresome after a relatively short period of time.

Cockpit discussions to follow are based on experimental tests which were conducted on a series with vertical distances between the horizontal lines of vision and the heel rests of 35 through 45" at 2 inch intervals. (A distance of 39 1/4" was selected in place of 39" in the study on cockpits with stick type control because that value is standard for pursuit aircraft.) For the moment, disregarding the function of seating as such, we may look at the dimensional requirements established for the various types of cockpits with the stick type control, which is most commonly used in fighters.

At the 35" stage, Figures IV, 4, and IV, 5, the pilot's eye is lying 35" vertically from his heel. The foot rests on the standard aircraft are 5" from the rudder pedal, and are thus used. The control column and the throttle in cruise positions lie 19" forward of a seat reference point. The reference point referred to will be defined below. The pilot actually sits 4-7/8" from

GERMAN AIR FORCE
Arrangement of Pilot's Seat, Controls, and
Instrument Panel in the Cockpit

All dimensions given in inches, tolerance about $\pm 1/16$, if not stated.
Body sizes: ----- 63"; ----- 69"; 75".

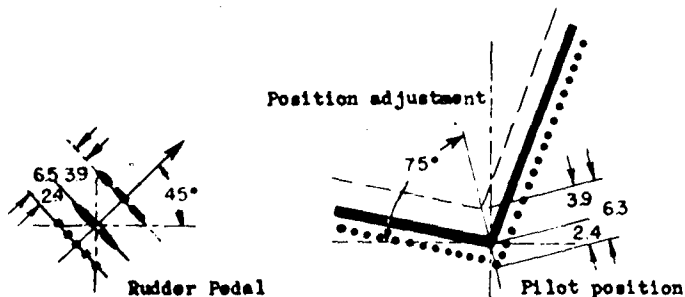
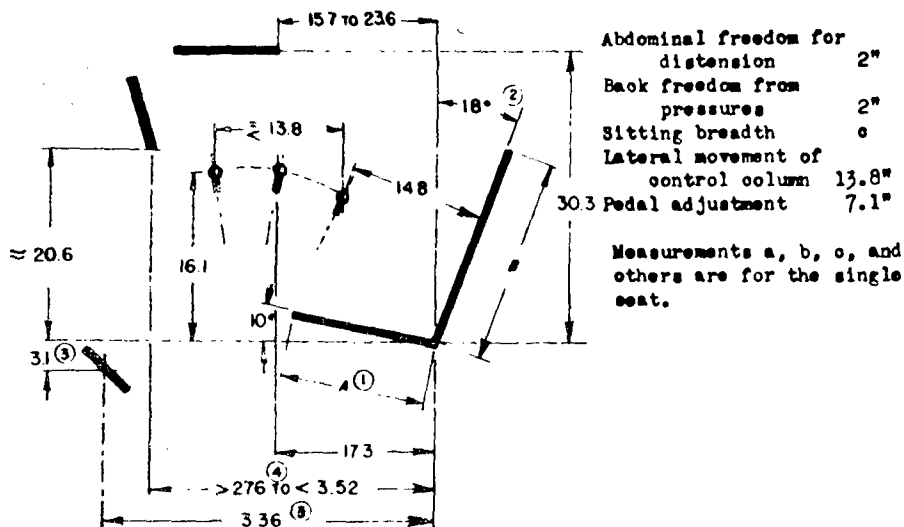

It is sufficient, when the adjustments are provided, for the seat and rudder pedal to be determined by the size of the pilot before flight. However, there must usually be a basis of variable adjustability during flight. If it is possible without difficulty, both adjustments can be about 7/9", whereby the adjustment of the seat is 3/5 coarse on the ground, and 2/5 fine during flight.

- 1) A G. F. E. control column is available.
- 2) Drawing tolerance $\pm 1^\circ$.
- 3) Don't increase, because that will materially increase the burden under high acceleration.
- 4) Avoid working parts on the instrument panel, in order to allow maximum accommodation of vision, and protect the man against injury.

4404C AML

Figure IV, 2.

NORMAL MEASUREMENTS FOR THE PILOT'S SEAT IN FIGHTER AIRCRAFT

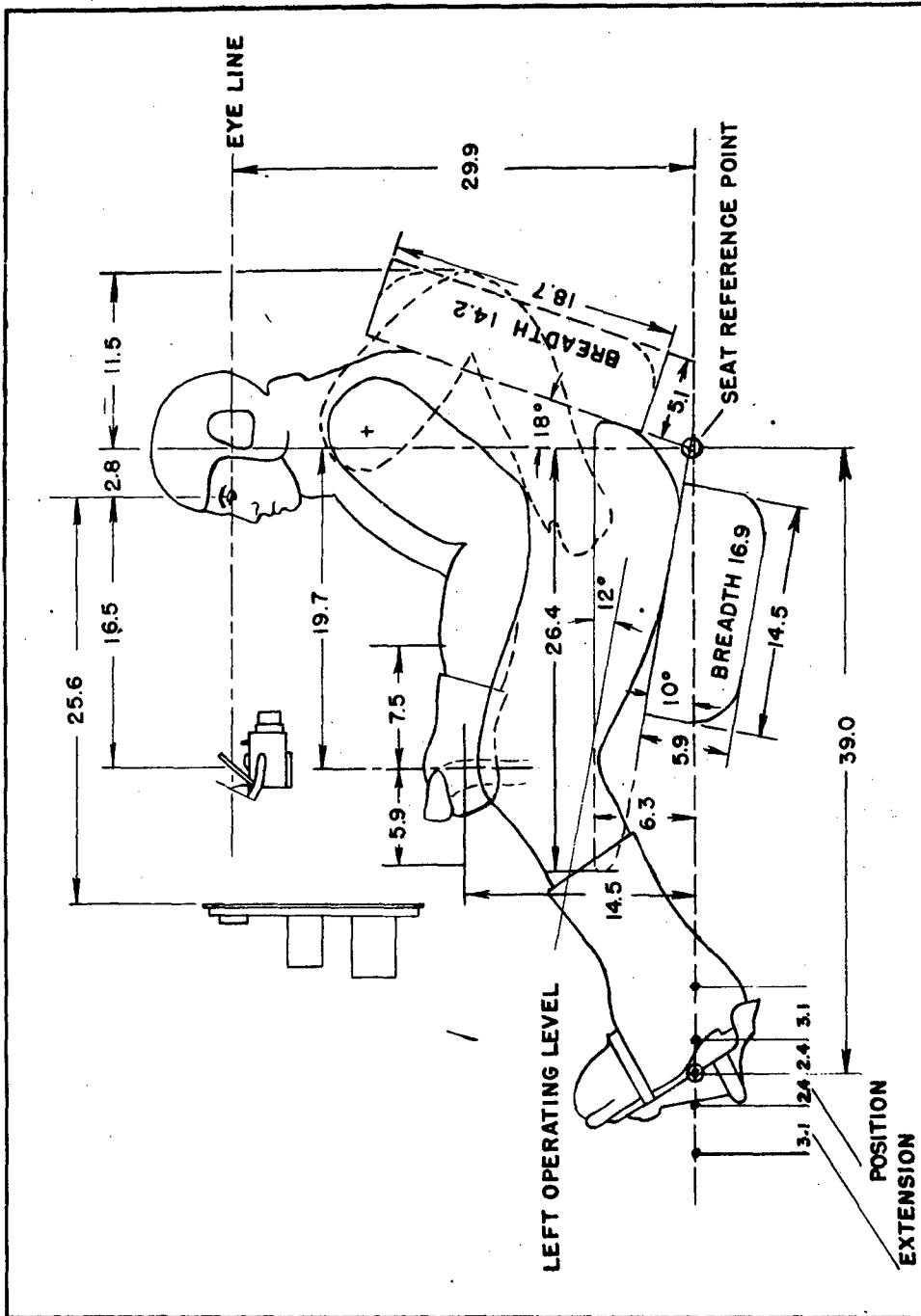

MEASUREMENTS SHOWN FOR SITTING IN MEAN POSITION

4404 AML

Figure 1, 3.

AVERAGE POSITION OF SEAT IN 36" FIGHTER COCKPIT

A. M. L. TEST SEAT

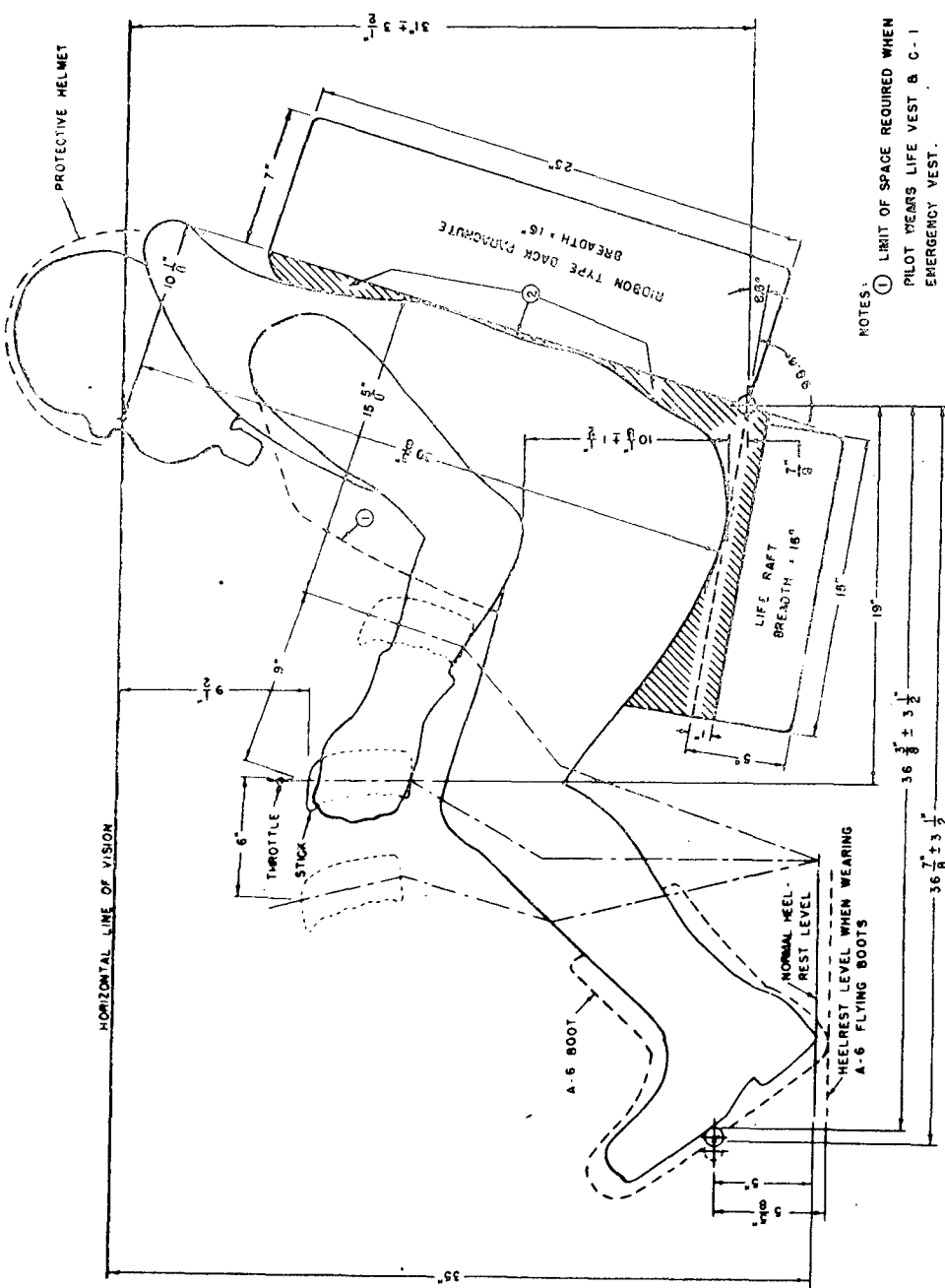

NOTES: ① LIMIT OF SPACE REQUIRED WHEN PILOT WEARS LIFE VEST & C-1 EMERGENCY VEST.
② HATCHED AREAS INDICATE CUSHIONING REQUIREMENTS.

4535 A II L

Figure IV, 4.

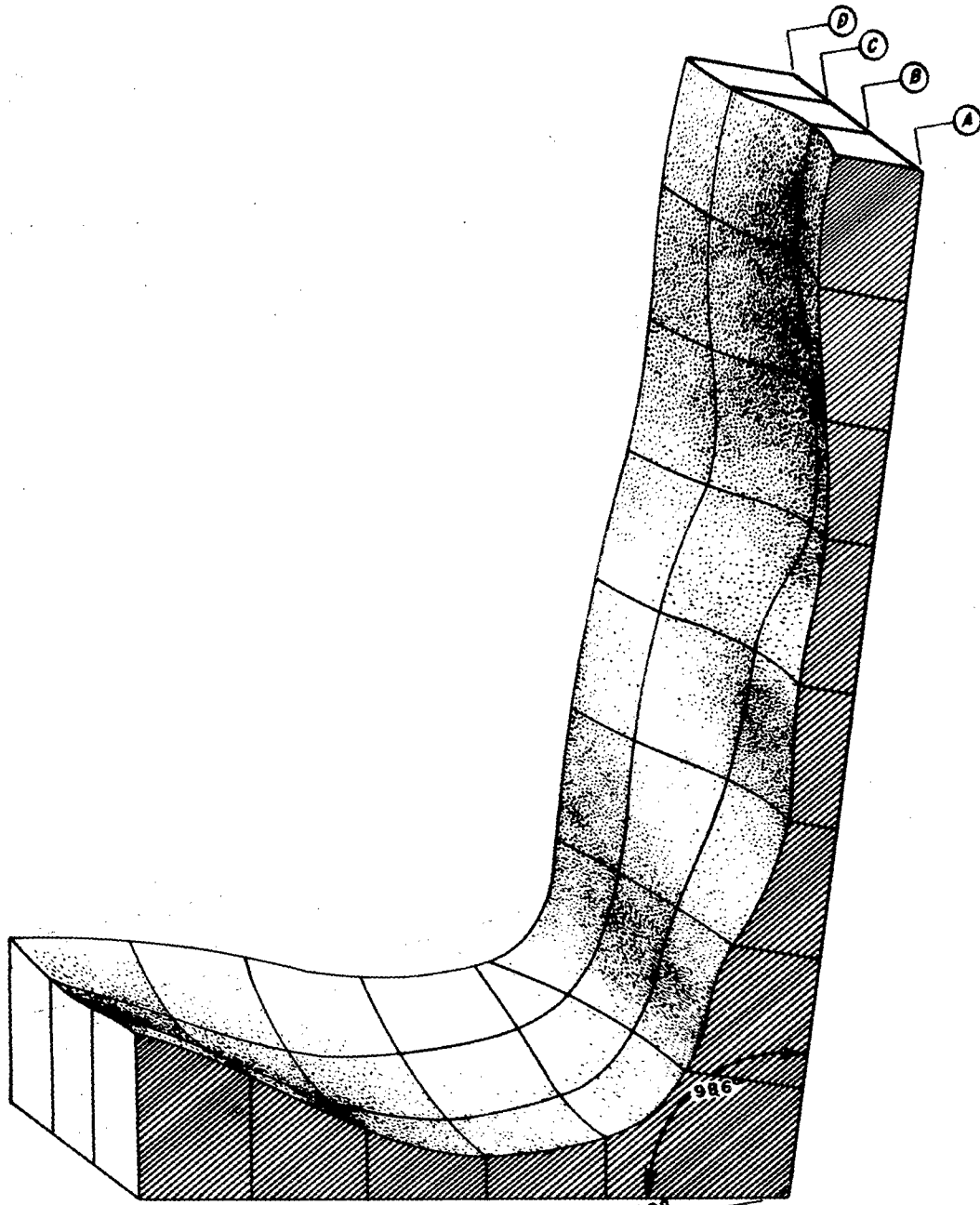

CHOICE COCKPIT AT 35 INCH LEVEL. MIDLINE SECTION OF SEAT CONTOURING (A)
 SHOWING PROFILES AT THREE INCH INTERVALS LATERALLY. (B, C, AND D)

Figure IV, 5.

4365-AML

the heel rest level, which is $1/8$ " less than the level of the rudder pedal. The rudder pedal, itself, is $36-3/8$ " forward of the reference point.

The reference point is not exactly the same as that defined previously, but is a point defined in relation to the actual position of the man and a functional cushion and back pillow supporting him. It is derived by the intersections of two lines, one tangent to the buttock at an angle from the horizontal determined by the position of the cushion, and second, the line tangent to the back in the thoracic region and determined in angle by the position of the back pillow. It will in effect mostly duplicate the presently defined reference point used by designers but has a different function inasmuch as it is defined with respect to the position of the man, rather than with respect to a position in reference to a seat. It is then a dynamic point which will vary in position with any variation in equipment back of and below the man, and is considered to be more useable from the functional standpoint of the man than the other point is from the static concept of the seat in the present discussion. However, if a dynamic concept of the other point were introduced rather than its present static one, it is felt that the points would be nearly identical.

The reference point, as used in this discussion, lies 4" above the heel rest level in the 35" cockpit. An arm rest, if installed, would lie $10-1/8$ " from the surface upon which the man is seated, and a true distance from this surface to a line drawn through the eye and perpendicular to the posterior line tangent to the back will measure $30-3/8$ ". The length of the line from the eye perpendicular to the back line measures $10-1/8$ "; a vertical distance from the eye to the surface upon which the man is seated is 31". The main considerations which should be given to the 35" cockpit are those to be determined from the required or expected performance of the contemplated aircraft. It is known, for example, that a man in this semi-reclining position will have a higher tolerance to acceleration forces than he would in a more nearly upright position. Therefore, a relatively higher performance of the man and the airplane combination could be expected. On the other hand, in high performance aircraft, requirements at present state that a down-vision angle of 11 and 12 degrees at 500 and 600 m. p. h. respectively is required, and it is at this 35" stage that the man's knees will be nearest to the horizontal line of vision. Therefore, the distance between the knee and the down-vision angle line will be at a minimum and careful consideration must be given to the size of the instruments installed directly in front of the pilot or else the instrument panel will interfere with the knee action. Further, any gunsights installed at this cockpit level should require a bare minimum of crouching-forward by the pilot for his use because it will be extremely difficult for such crouching to occur due to the fact that the pilot is in the semi-reclining position.

Further consideration should be given to the fact that the pilot is seated at a mean position only $4-7/8$ " from the floor. At present, the personal equipment, including the one-man life raft and cushion will measure at least 5", and may go to 10", and thus a well should be provided beneath the seat to permit down adjustment. In other words, the seat at full-down adjustment will permit the man to be only $1-3/8$ " above the floor. The well would then have to be 9"

deep below the heel rest, in order to permit full accommodation of pilot statures.

By full accommodation we mean the ability of a cockpit's functional structure to permit the pilot's eye, regardless of his stature, to be maintained at the horizontal line of vision. It is well enough to say that this is an unimportant requirement inasmuch as the man may well ride the aircraft with his eye above the desired line of vision. However, a start must be made somewhere in setting requirements for the dimensions of aircraft cockpits, and if such a practice is maintained as to define a canopy 8" above the horizontal line of vision in the design, and if such a practice also incorporates gunsights on the horizontal line of vision and in calculating down-vision angles, it is not unreasonable to expect the cockpit to provide for the pilot's eye on this line of vision. It should also be pleasing to the aerodynamics engineers to be able to depend upon a fixed position of a pilot's head in an aircraft in such a manner that unsatisfactory reports will not be following up production stages of an aircraft which will require that canopies be raised in order to permit a higher degree of head movement. There is no fighter at the present time which has incorporated in its cockpit a method of adjustment by which the pilot's eye stays no higher than the design line of vision.

It will also be noticed in referring to the drawings that the boots worn by the manikin extend below the heel rest level, and beyond the rudder position. This will indicate that cockpits which require heavy clothing will also have to be slightly larger to accommodate it.

In the 37" stage, Figures IV, 6; IV, 7, the pilot sits 8" from the floor, with the reference point $7\frac{1}{4}$ " from the heel rest level. At $3\frac{1}{2}$ " down adjustment the pilot sits $4\frac{1}{2}$ " from the heel level, with the reference point at $3\frac{3}{4}$ ". Considering again the fact that at least 5" of personal equipment may be under the man, we must again consider the provision of a well under the seat at least 2" deep. The rudder pedals are $35\frac{3}{4}$ " in front of the reference point; the arm rest is $9\frac{1}{4}$ " above the surface upon which the man is sitting; the distance from the surface of the seat to the eye perpendicular to the back line is $29\frac{3}{8}$ "; the eye-back line distance is $9\frac{3}{4}$ "; and the vertical distance from the eye to the reference point is $29\frac{3}{4}$ ". The reasons for the variations in these dimensions will be discussed later.

The $39\frac{1}{4}$ " cockpit, Figures IV, 8; IV, 9, has raised the man to $9\frac{3}{8}$ " from the heel level with a reference point of $8\frac{3}{4}$ ", and with a $3\frac{1}{2}$ " down adjustment the reference point will be $5\frac{1}{4}$ " from the heel rest level. Therefore, we have finally reached a cockpit level which will permit 5", but no more, of personal equipment under the man without requiring some welling of the floor. Rudder pedals are $35\frac{1}{2}$ " from the reference point; arm rest is at $8\frac{3}{8}$ "; seat-to-eye distance is $30\frac{1}{8}$ "; eye-to-back line $9\frac{3}{8}$ "; and the vertical distance from the eye to the seat $30\frac{1}{2}$ ".

The 41" cockpit, Figures IV, 10; IV, 11, holds the man $10\frac{1}{8}$ " from the heel rest, and the reference point $9\frac{1}{2}$ ", permitting 6" of space between the point and the floor at seat full down. The reference point-pedal distance is $35\frac{1}{8}$ ";

AVERAGE POSITION OF SEAT IN 37" FIGHTER COCKPIT

A. W. L. TEST SEAT

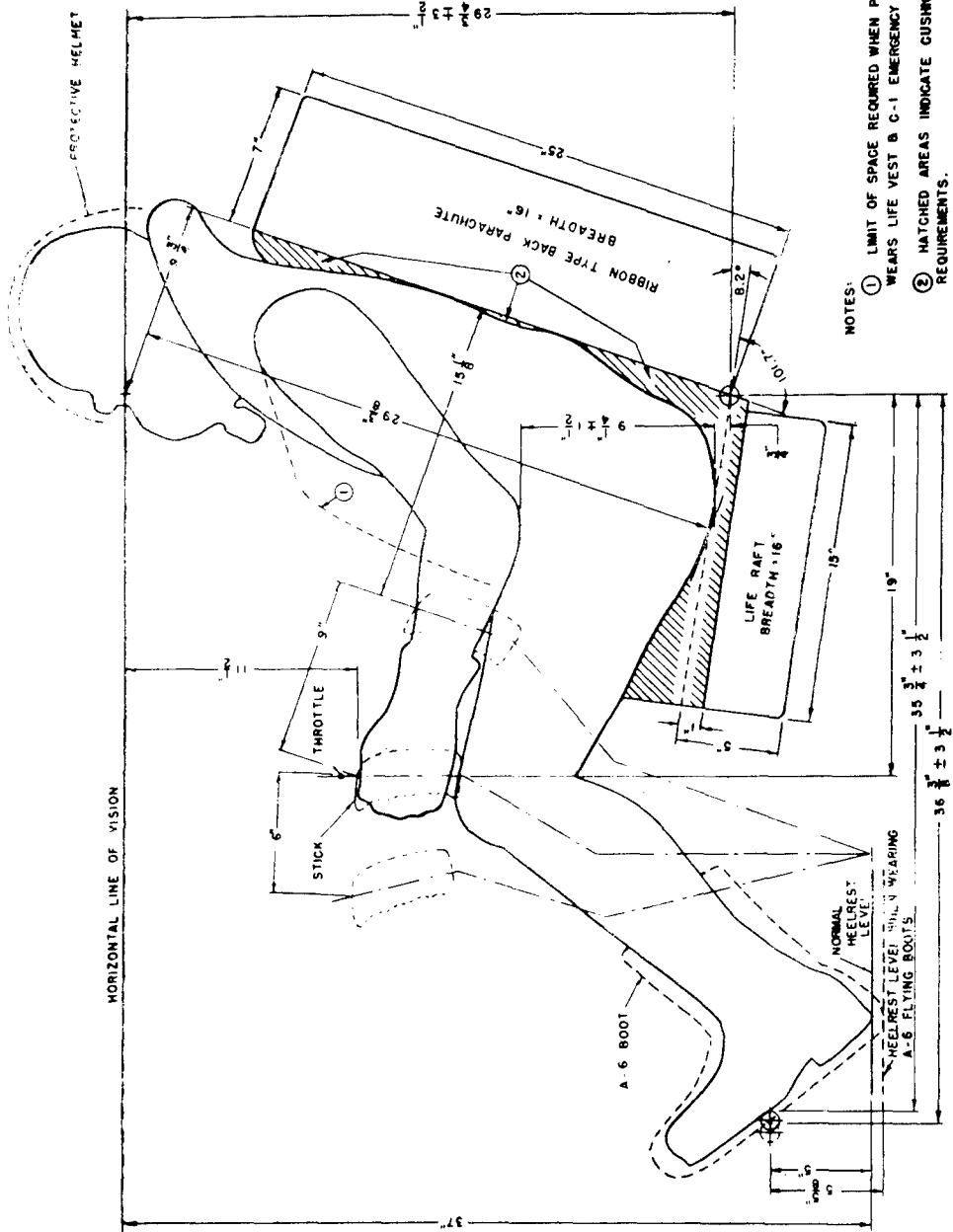

45164-J 1

Figure IV, 6.

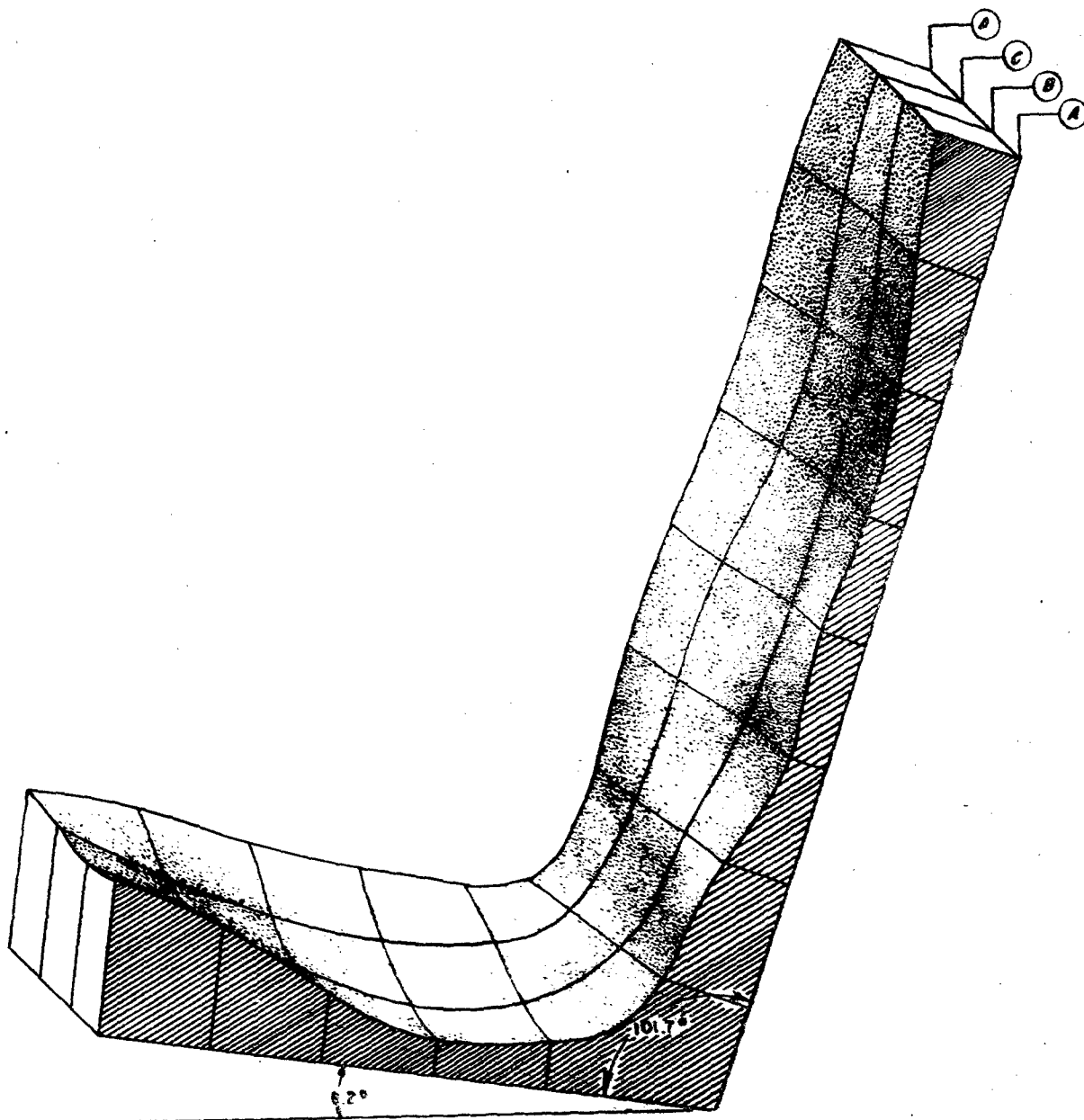
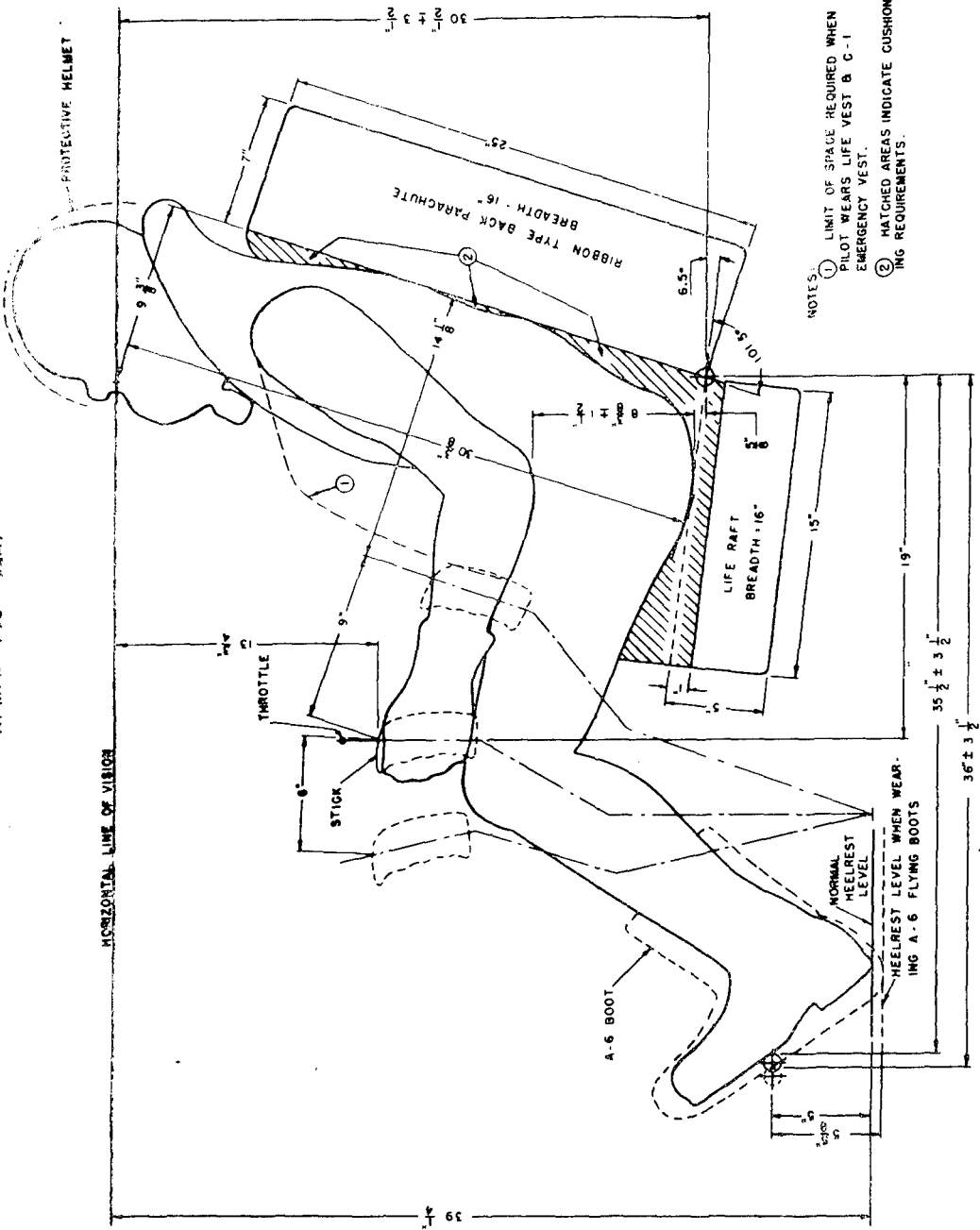

Figure IV, 7.

CHOICE COCKPIT AT 37 INCH LEVEL. MIDLINE SECTION OF SEAT CONTOURING (A)
 SHOWING PROFILES AT THREE INCH INTERVALS LATERALLY (B, C, AND D)
 4365-A-AML

AVERAGE POSITION OF SEAT IN 39 1/2" FIGHTER COCKPIT

A. M. I. TEST SEAT



NOTES:

- (1) LIMIT OF SPACE REQUIRED WHEN PILOT WEARS LIFE VEST & C-1 EMERGENCY VEST.
- (2) HATCHED AREAS INDICATE CUSHIONING REQUIREMENTS.

45150-A M L

Figure IV, 8.

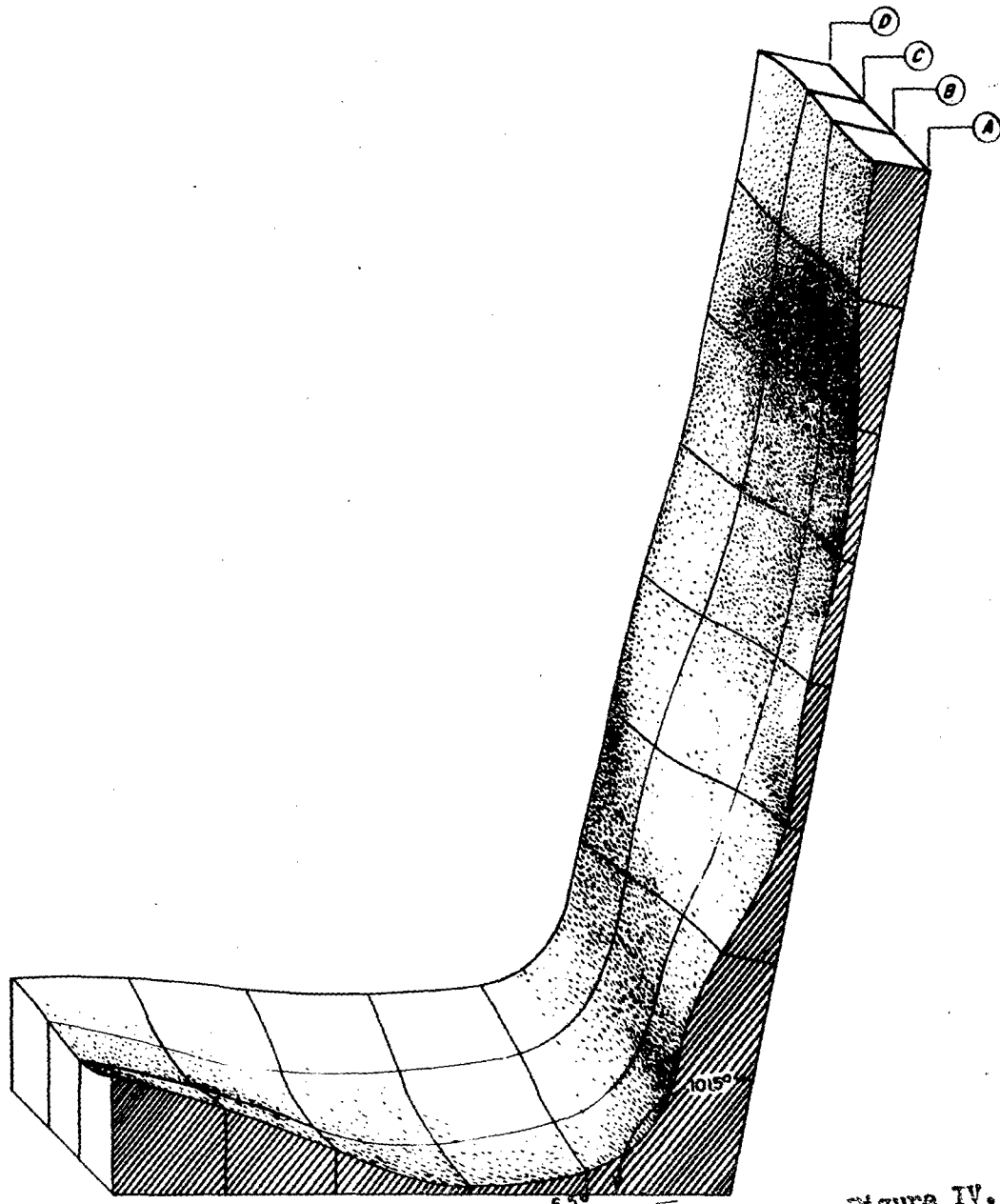

Figure IV, 9.

CHOICE COCKPIT AT 39 1/4 INCH LEVEL MIDLINE SECTION OF SEAT CONTOURING (A),
 SHOWING PROFILES AT THREE INCH INTERVALS LATERALLY (B, C, AND D)

4385-C - AML

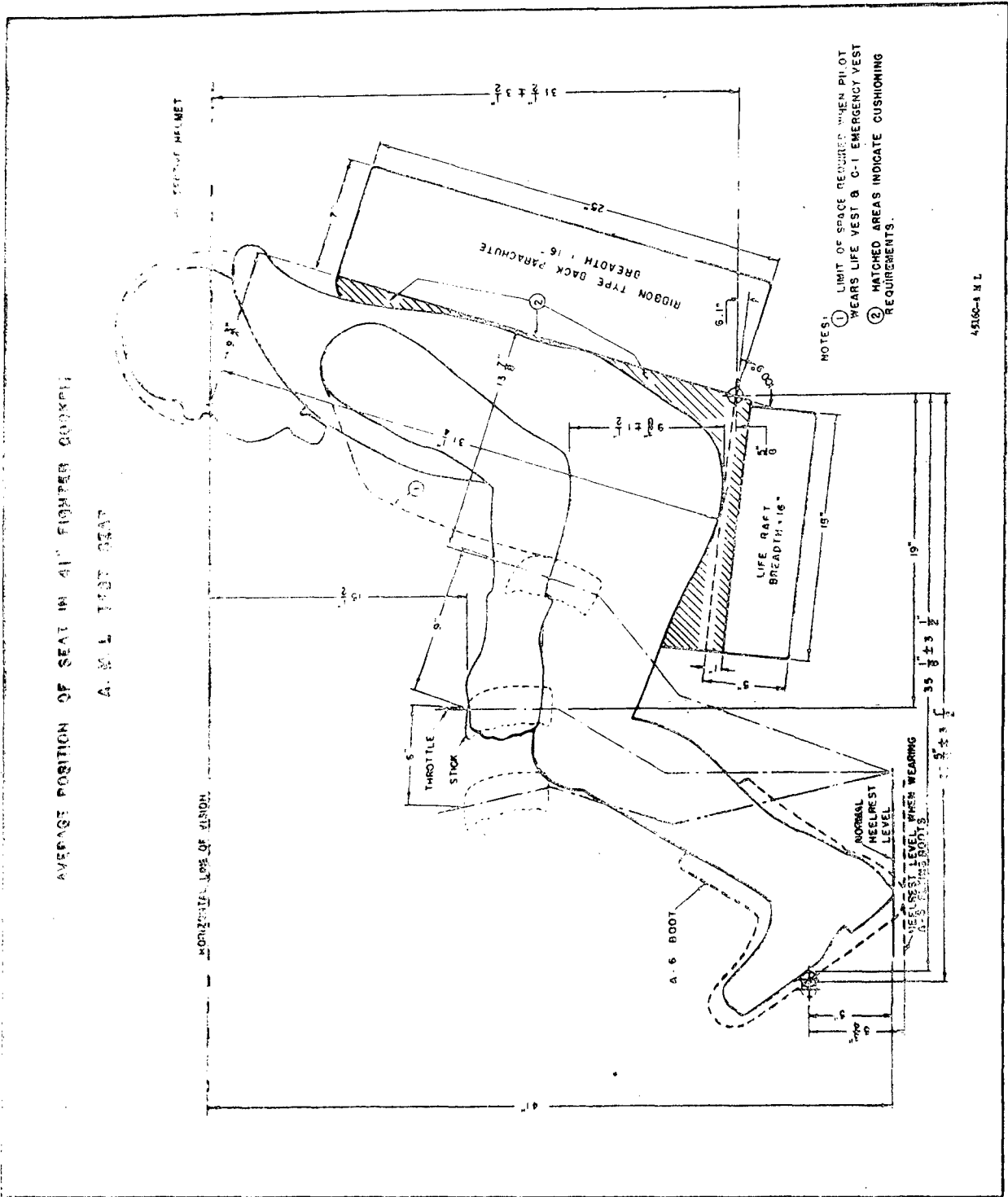

Figure IV, 10.

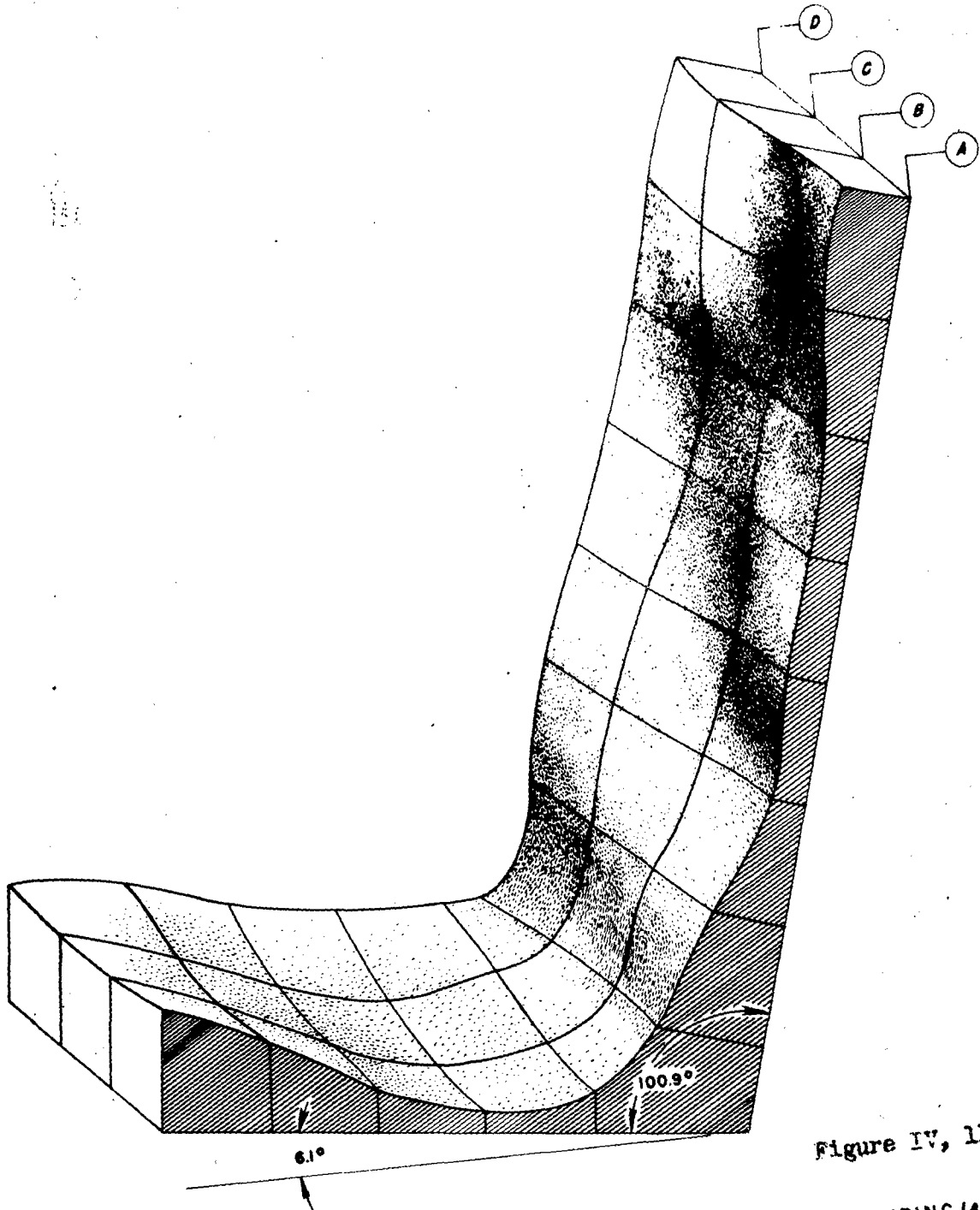

Figure IV, 11.

CHOICE COCKPIT AT 41 INCH LEVEL. MIDLINE SECTION OF SEAT CONTOURING (A)
 SHOWING PROFILES AT THREE INCH INTERVALS Laterally (B, C, AND D)

4365-B-AML

arm rest height is $9\text{-}\frac{3}{8}$ " ; seat-to-eye, $31\text{-}\frac{1}{4}$ " ; and eye-to-back line $9\text{-}\frac{3}{4}$ " , with the vertical eye-to-seat, $31\text{-}\frac{1}{2}$ " .

The 43 " cockpit, Figures IV, 12; IV, 13, at first may appear to be in an extreme position, inasmuch as it has raised the man $11\text{-}\frac{7}{8}$ " from the heel level, with the reference point $11\text{-}\frac{1}{2}$ " high, giving us a full 8 " to work with after the seat is at full-down adjustment. Reference point-pedal distance has dropped to $34\text{-}\frac{3}{4}$ " ; arm rest height to 9 " ; seat-to-eye distance to $31\text{-}\frac{3}{4}$ " ; eye-to-back to $9\text{-}\frac{5}{8}$ " ; and the vertical seat-to-eye to $31\text{-}\frac{1}{2}$ " . Contrary to the statement made on the 35 " cockpit, the 43 " level now gives the maximum distance between the horizontal line of vision and the knees. It has been found in experimental designs of cockpits utilizing the A-1 gunsight that this level is required for proper utilization of the gunsight, the 11 degrees down-vision angle, and some instrument panel above the knees. This example serves well to illustrate the fact that one instrument may be the deciding factor of what cockpit can be selected for a design, and in this particular case it must be realized that the A-1 sight is a high performance sight, and the 11 degrees a high performance condition, whereas the 43 " cockpit from the standpoint of the man is a low performance position.

Certain other dimensions are valuable for consideration. One in particular should be mentioned, and that is the distance between the most aft position of the control column and the back surface upon which the man rests. At the 35 " level there is available a distance of $15\text{-}\frac{1}{8}$ " , whereas in progressing upwards in the levels, this distance decreases exactly 2 " to $13\text{-}\frac{1}{8}$ " .

Before proceeding to a discussion of the relative merits of the different levels of the cockpits there should be some consideration given to the man and the structure which we term a seat and which provides the function which we term seating.

Involved in the dimensional relationships of the cockpits discussed above are two very important factors which should be clearly understood in order to give a full consideration to the general principles of cockpit seating. The most important factor is the function of the anatomy of the man as he is being placed into what is called a seated position. It is easy enough to understand the method by which a knee joint, for example, moves as it occurs only through a given plane. It is much more difficult, however, to understand the highly involved mechanism through which the vertebral column may be comfortably placed adjacent to a supporting surface and be supported in a seated manner.

There are twenty-five separate and distinct bones in the human vertebral column. A common conception of the function of the twenty-four individual joints is that they may operate independently of each other. If this were so, it would be much easier to obtain a variety of seating postures. However, this is not so. The main areas in which the vertebral column may be flexed or extended are the lumbar or lower back areas and the cervical or neck areas. The vertebrae supporting the ribs move only a slight amount relative to the entire movement of the vertebral column. This may be tested for informational purposes simply by standing erect and then bending over as if to touch the toes.

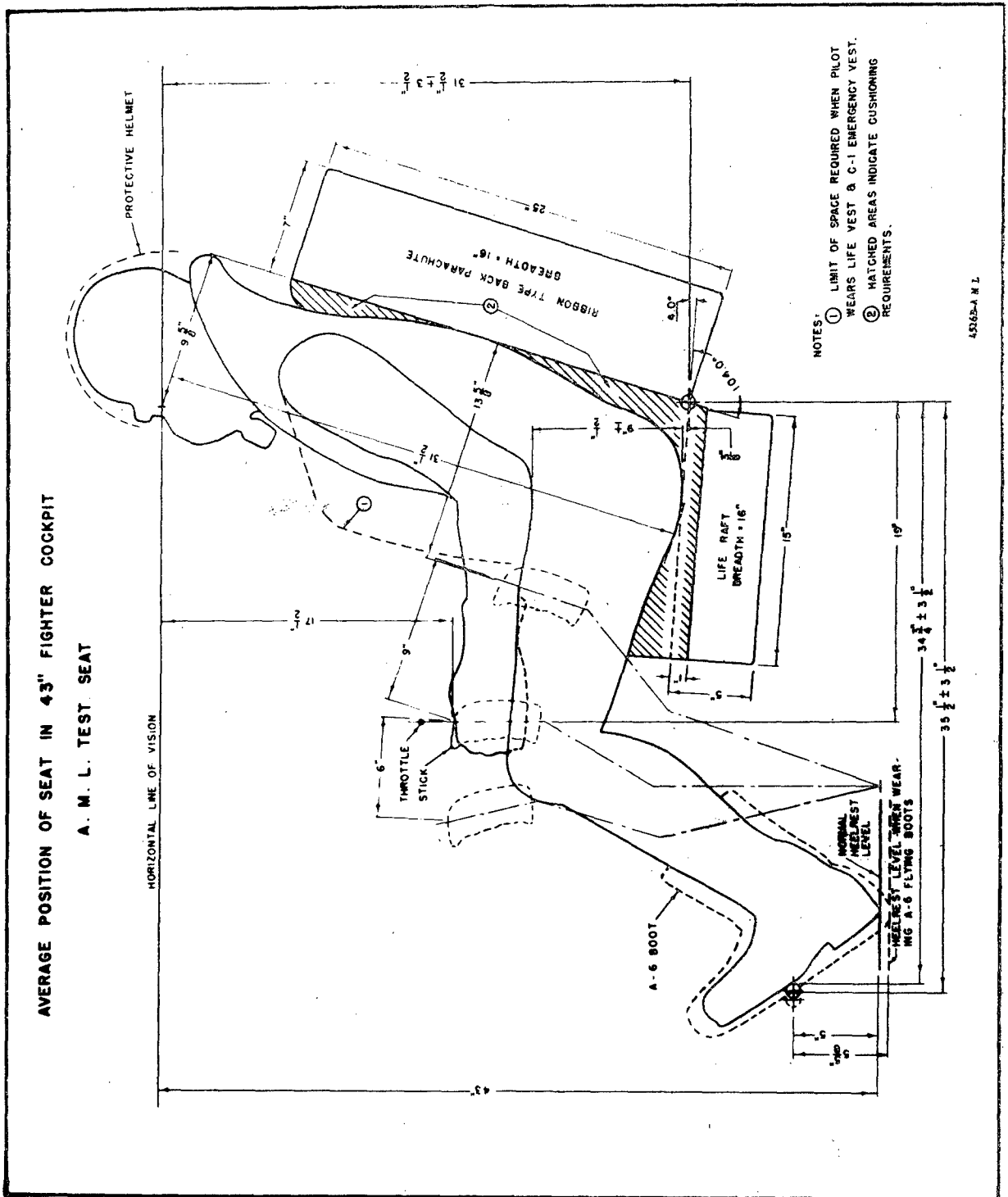

Figure IV, 12.

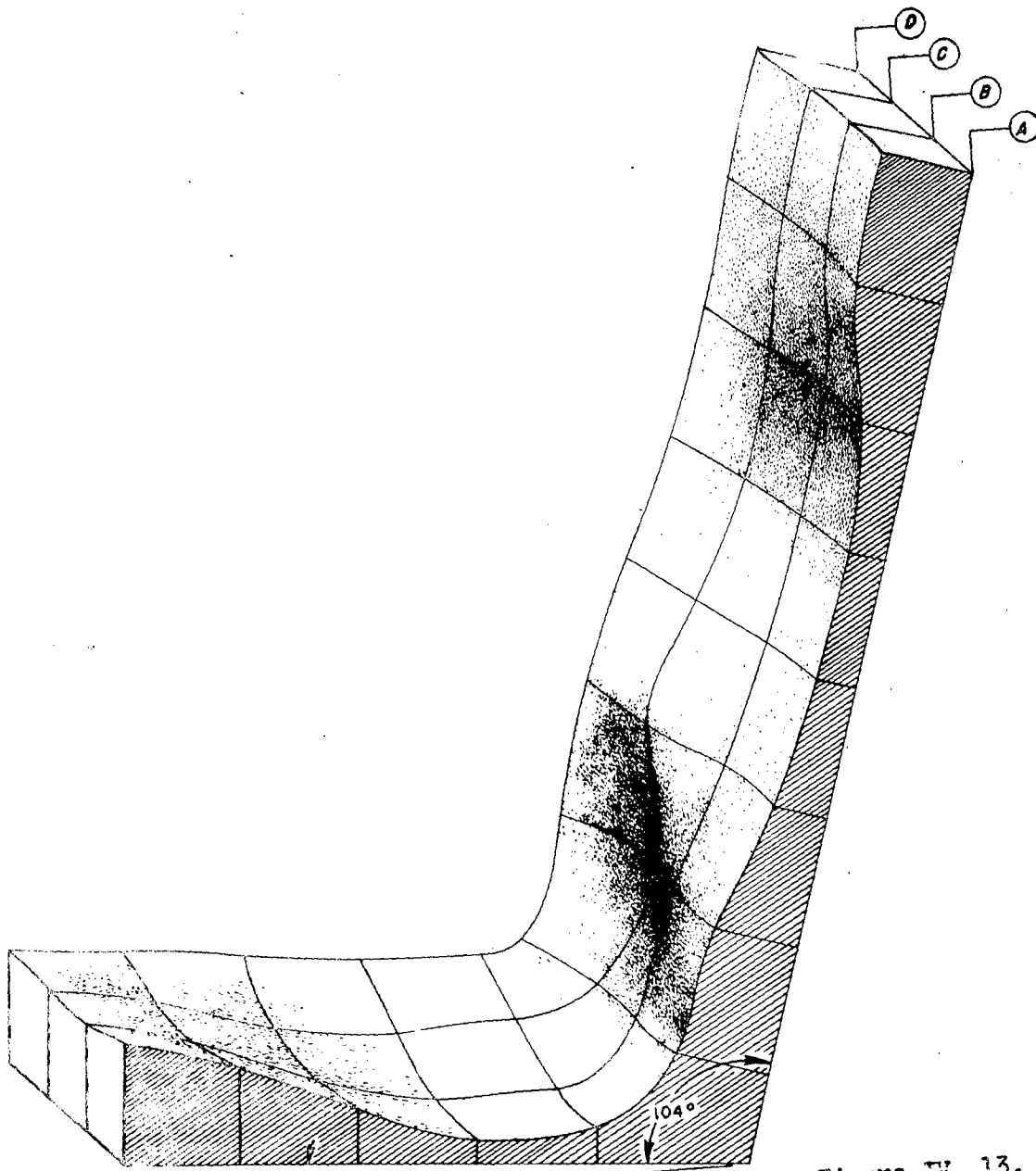

Figure IV, 13.

CHOICE COCKPIT AT 43 INCH LEVEL. MIDLINE SECTION OF SEAT CONTOURING (A)
 SHOWING PROFILES AT THREE INCH INTERVALS LATERALLY (B, C AND D)
 4365-D-AML

It will be noted that some flexing occurs at the hip joint, a great deal of flexing occurs in the lower back region, and practically no flexing occurs in the thoracic region. Normally, in an erect posture, the column viewed from the side is in what is called a sigmoid shape, with the cervical vertebrae curved forward, the thoracic vertebrae curved backward, and the lumbar vertebrae curved forward. This posture, the normal one, will change in a seated or flexed position only in the lumbar region so far as comfort conditions are concerned. Inasmuch as the thoracic vertebrae do not change their positions, they must be held in such a manner that the cervical vertebrae above them will still retain the head in its normal horizontal position in order to maintain a comfortable position. Therefore, the fundamental factor in maintaining a comfortable seated position, so far as the back is concerned, is to flex the lumbar region within its allowable limits in such a manner as to retain the thoracic and cervical regions in their normal vertical alignment. So far as the gluteal and thigh regions are concerned, the angular deflection is relatively simple, and comfort appears to be entirely dependent upon the maintenance of the largest possible surface area for the support of the weight concerned.

Therefore, the fundamental requirement for comfortable seating is the proper application of mechanical forces to the bony body structures in such a manner as not to displace them beyond their normal comfortable angular limits. The second fundamental requirement is dependent upon the first, and is, in effect, the proper determination and use of the mechanical forces which are applied by means of pillows, cushions, etc., to the human body. The following discussion of seating will be based on the assumption, through experimental test data, that seating mechanics have been properly applied to the human body, and that the dimensional relationships of the cockpit are those which will best fit the human body itself in the variety of seating which will be within the tolerable comfort limits of the skeletal system.

In the 35" cockpit the lower leg is flexed on the thigh at an angle of about 110 degrees. The thigh has been flexed on the trunk at an angle of about 80 degrees. Because of this degree of flexion, the cushion support system must be maintained at an angle of approximately 9 degrees from the horizontal. This 9 degrees from the horizontal is not readily interpreted as a surface contact to the thigh and buttock region but rather as a base line angle which supports the resilient system which provides a differential weight support with the highest value lying over the ischial tuberosities and decreasing values in all directions from these two points. The vertebral column itself will show the greatest amount of curvature in the lumbar region, and this is demonstrated by the fact that the seat-to-eye distance at this level is relatively low. Even though the lumbar region itself has probably been forced into the greatest amount of flexure possible, the thoracic region is still maintained in such a position that the upper thoracic vertebrae will provide proper alignment for the cervical or neck vertebrae to maintain the head in its normal horizontal, and comfortable, position. In every case on the experimental tests, the upper thoracic curvature has been determined to continue upward in such a manner if extended as to intersect the horizontal line of vision at very nearly 90 degrees, which proves that the head must be maintained in its normal position if comfort is to be maintained.

As the cockpit levels are increased the degree of flexion of the lower leg from the thigh increases little, and in the 43" cockpit the angle of the thigh and the lower leg has reduced to 108 degrees, but this decrease is related to the angular relationship of the thigh and the trunk which has increased to 98 degrees. In other words, there has been described an arc at the knee joint which has started from the 35" level and has proceeded upward and forward in such a manner as to retain the required amount of leg motion for the feet upon the pedals, and the trunk has been lifted vertically and has been supported more erectly on the thigh. In going through this process, the angle necessary for the support cushion under the thighs has decreased from 9 degrees at the 35" level to such an extent that the seat-to-eye distance has now reached the greatest value encountered.

Reference to the profile drawings will show that the distance from the knee to the horizontal line of vision will indicate the arc movement through which the knee has progressed. It appears further that the greatest flexion of the trunk occurs at the 37" level, with some straightening occurring below at the 35" level, apparently due to the rise of the thighs and a resulting reduction of compression in the abdominal region.

Further analyses of the cockpits have indicated that the 37" to 41" levels require the least change in accommodation of the pilot, whereas below and above these values the changes required are increased in value.

PILOT SEATING IN COCKPITS WITH WHEEL-TYPE CONTROL:

The problems encountered in pilot seating in cockpits where the wheel type control is used, which is predominantly in bombers, are essentially the same as those in stick-type control airplanes (predominantly fighters), insofar as the same type of work, generally, is performed in each case and thus the pilot requires virtually the same positioning. The differences which do exist, however, are all in favor of the bomber pilot, for they are differences in degree of restriction in position to which the respective pilots are held. Bomber cockpits are usually larger than fighter cockpits, thus permitting more arm and leg freedom and the incorporation of some back angle adjustment in the seat. Since scanning is not so constant an occupation for the bomber pilot as it is for the fighter pilot, the design Horizontal Line of Vision fails to be as restrictive a dimension for the former, i.e., the bomber pilot is relatively more free to select vertical seat adjustment within the prescribed range of adjustability which will meet his comfort requirements without any detrimental sacrifice of visibility, with the exception of down-vision requirement over the nose.

Studies on bomber pilot seating, for which returnee bomber pilots exclusively were used as subjects, have not only substantiated the above premises but have gone a step further and have revealed certain other differences in seating requirements between fighter and bomber pilots. The bomber pilot prefers a seat with a greater back angle, for example, due, perhaps, to the fact that in the absence of the almost constant alertness for enemy action and positioning to the gunsight to which the fighter pilot is necessarily subjected, he can fly in a more relaxed sitting attitude. Bomber pilots tend to be taller and heavier than fighter pilots, a difference which is reflected in the seat angle which they require for comfort and in the seat and back contours which they establish. The latter is strikingly apparent when direct comparisons are made (Cp. Fig's IV, 6 and LV, M: IV, 8 and IV, 16; IV, 10 and IV, 18; and IV, 12 and IV 20).

Despite the fact that the bomber pilot is not tied down too severely to the design horizontal line of vision, it was felt to be advisable to use the distance between the cockpit floor level (point of heel rest) and the horizontal line of vision as the fundamental dimension for cockpit design in order to have some one independent variable from which to work. First of all, this dimension is the most easily controlled; secondly, it is so fundamentally a determining factor in aircraft design; and, thirdly, it has definite limits which depend upon the normal range of stature of flying personnel. Since the comfort requirements as stated above for aircraft with the stick-type control show that a value of 35 inches for the heel-to-horizontal line of vision dimension represents nearly the absolute minimum at which the average AAF pilot can be accommodated in comfort, and a value of 43 inches represents nearly the maximum, a range of values at two-inch intervals from 37 inches to 45 inches was chosen for the study on wheel control aircraft. The shift in range by a two inch increase was made for two reasons, - first because of the generally larger size of bomber pilots, and secondly because these aircraft may require higher eye levels for down-vision.

AVERAGE POSITION OF SEAT IN 37" BOMBER COCKPIT

A. M. L. TEST SEAT

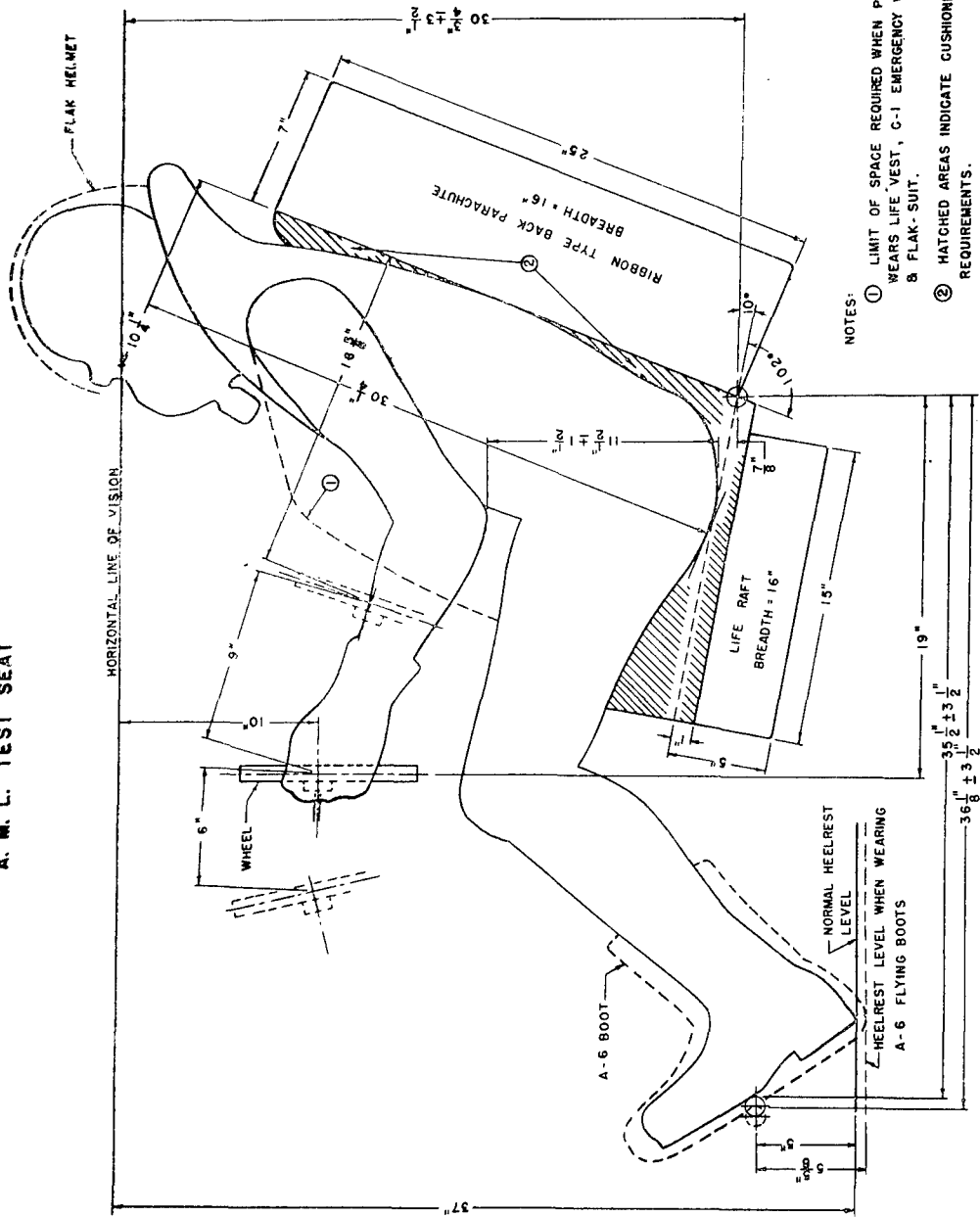

4509 AUC

Figure IV, 14

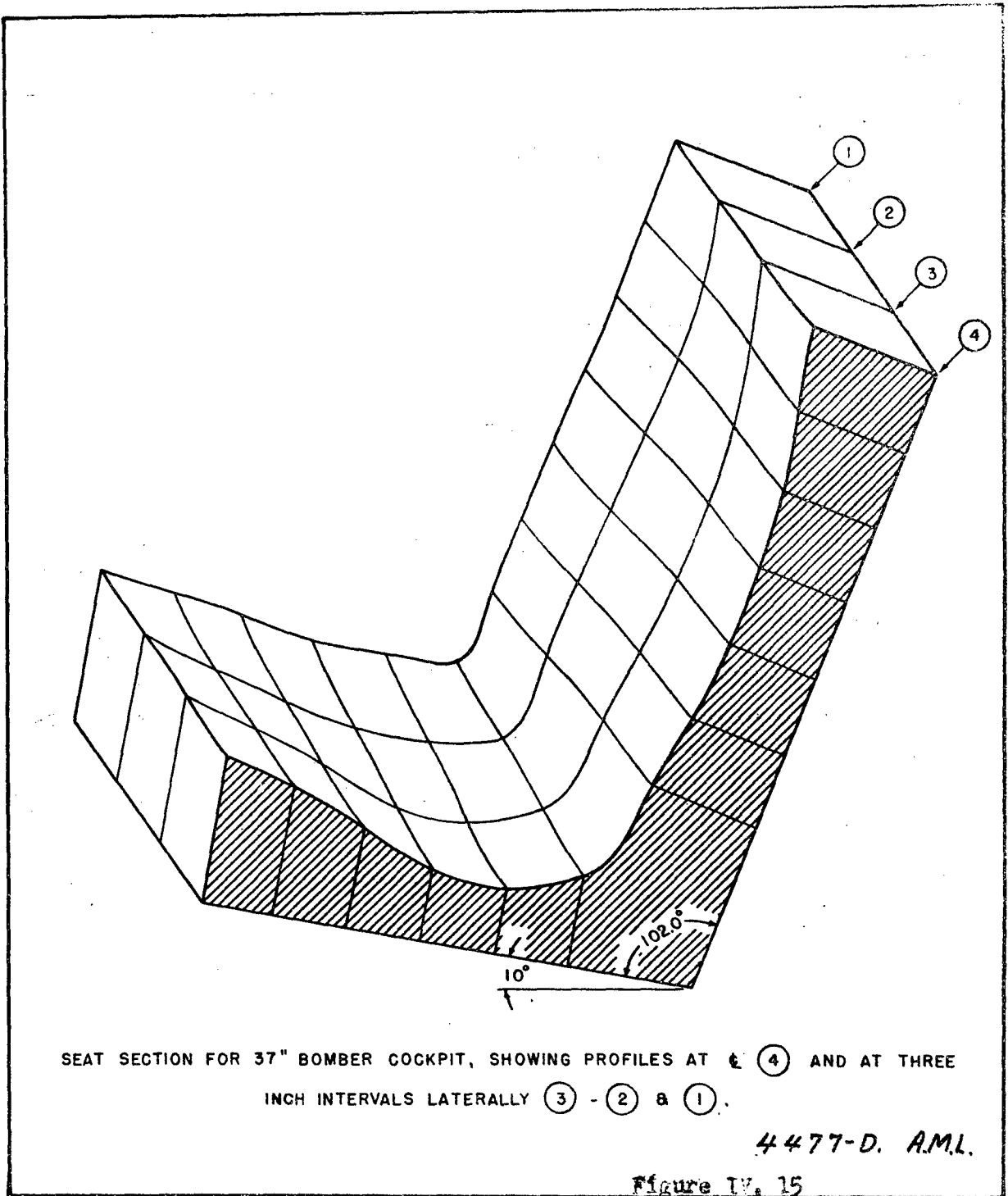

SEAT SECTION FOR 37" BOMBER COCKPIT, SHOWING PROFILES AT ϵ (4) AND AT THREE INCH INTERVALS LATERALLY (3) - (2) & (1).

4477-D. A.M.L.

Figure IV. 15

AVERAGE POSITION OF SEAT IN 39" BOMBER COCKPIT

A. M. L. TEST SEAT

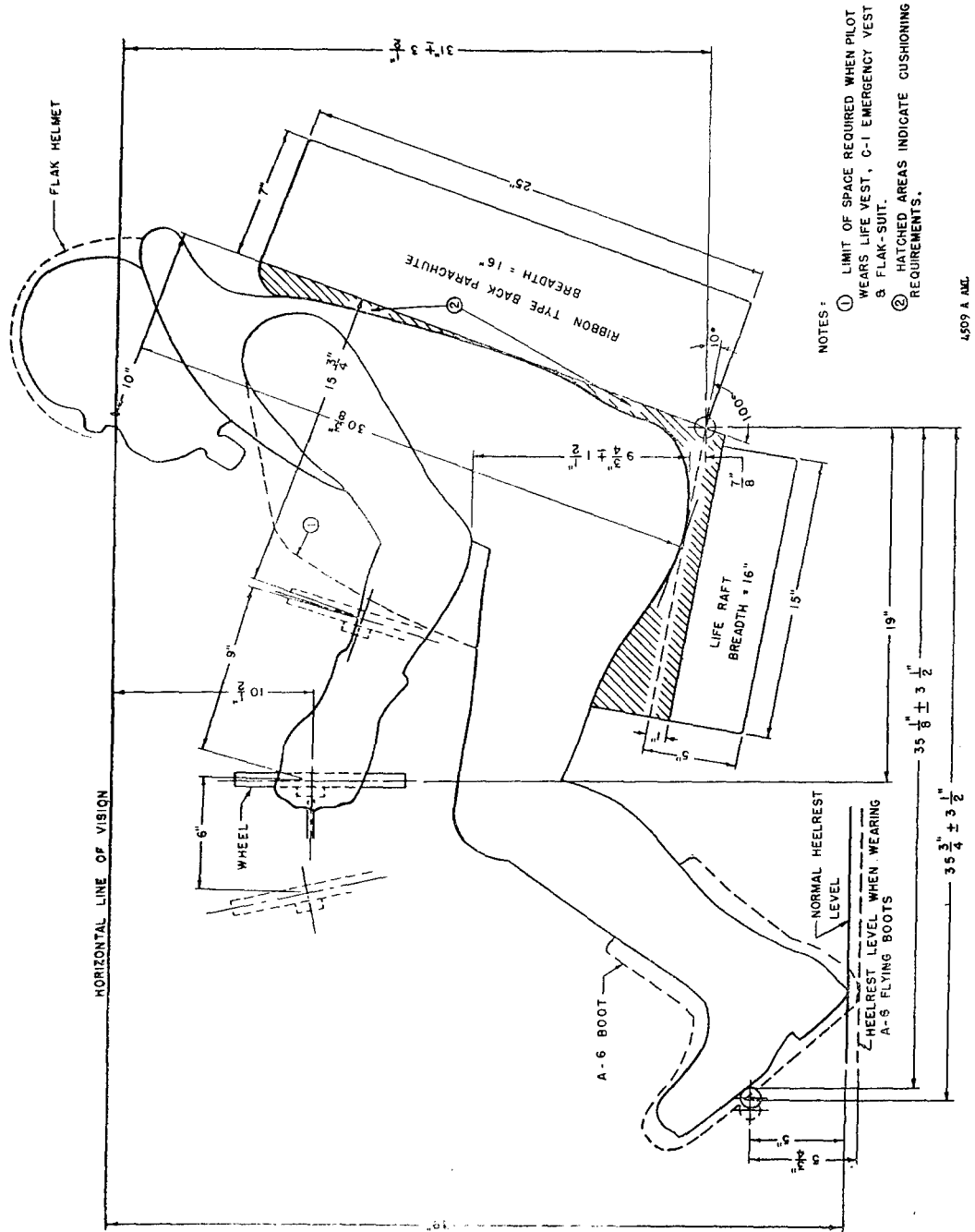
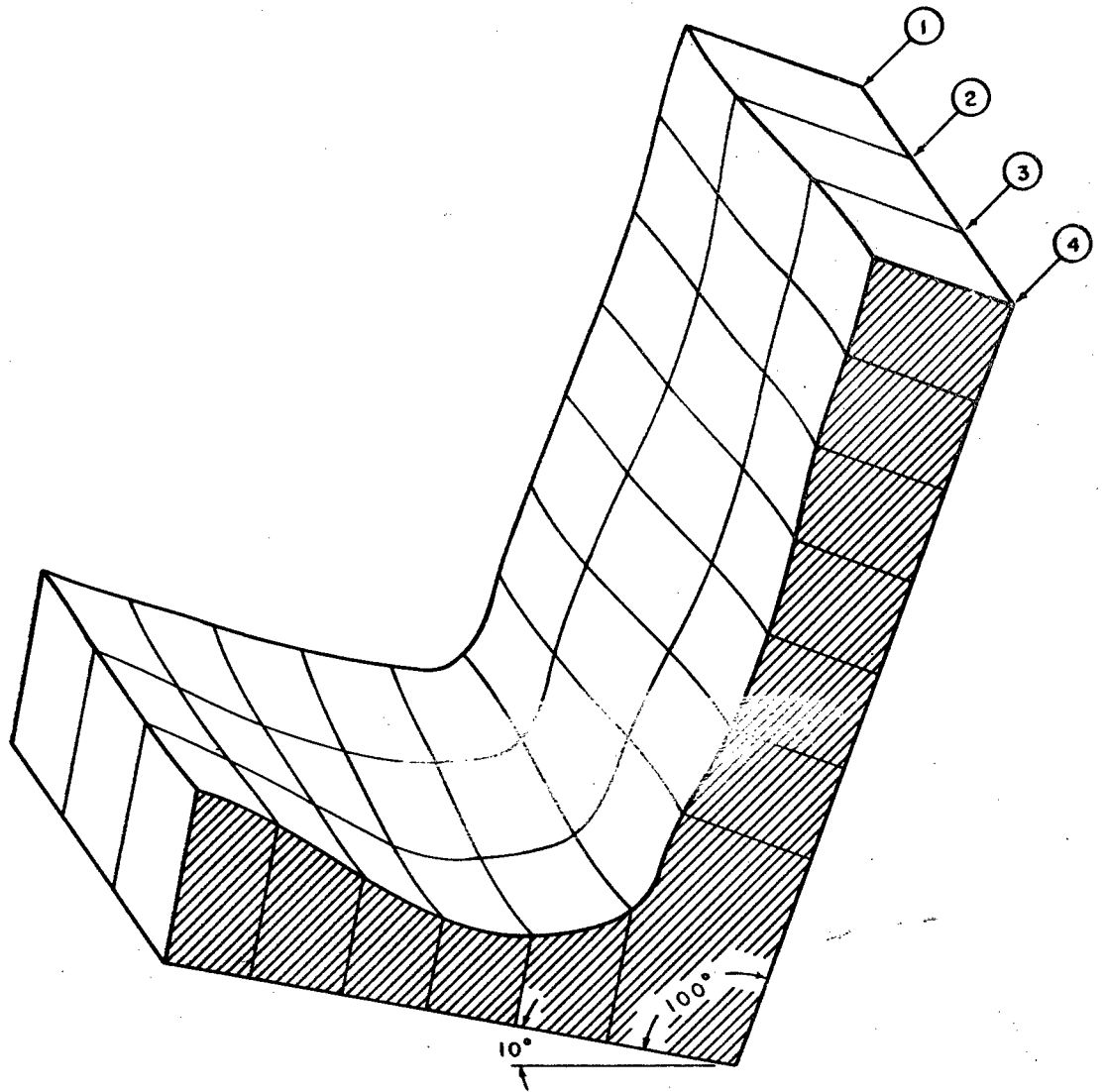

Figure IV, 16



SEAT SECTION FOR 39" BOMBER COCKPIT, SHOWING PROFILES AT $\frac{1}{2}$ (4) AND AT
 4477-C. AML. THREE INCH INTERVALS LATERALLY (3) - (2) & (1).

Figure IV, 17

AVERAGE POSITION OF SEAT IN 41" BOMBER COCKPIT

A. M. L. TEST SEAT

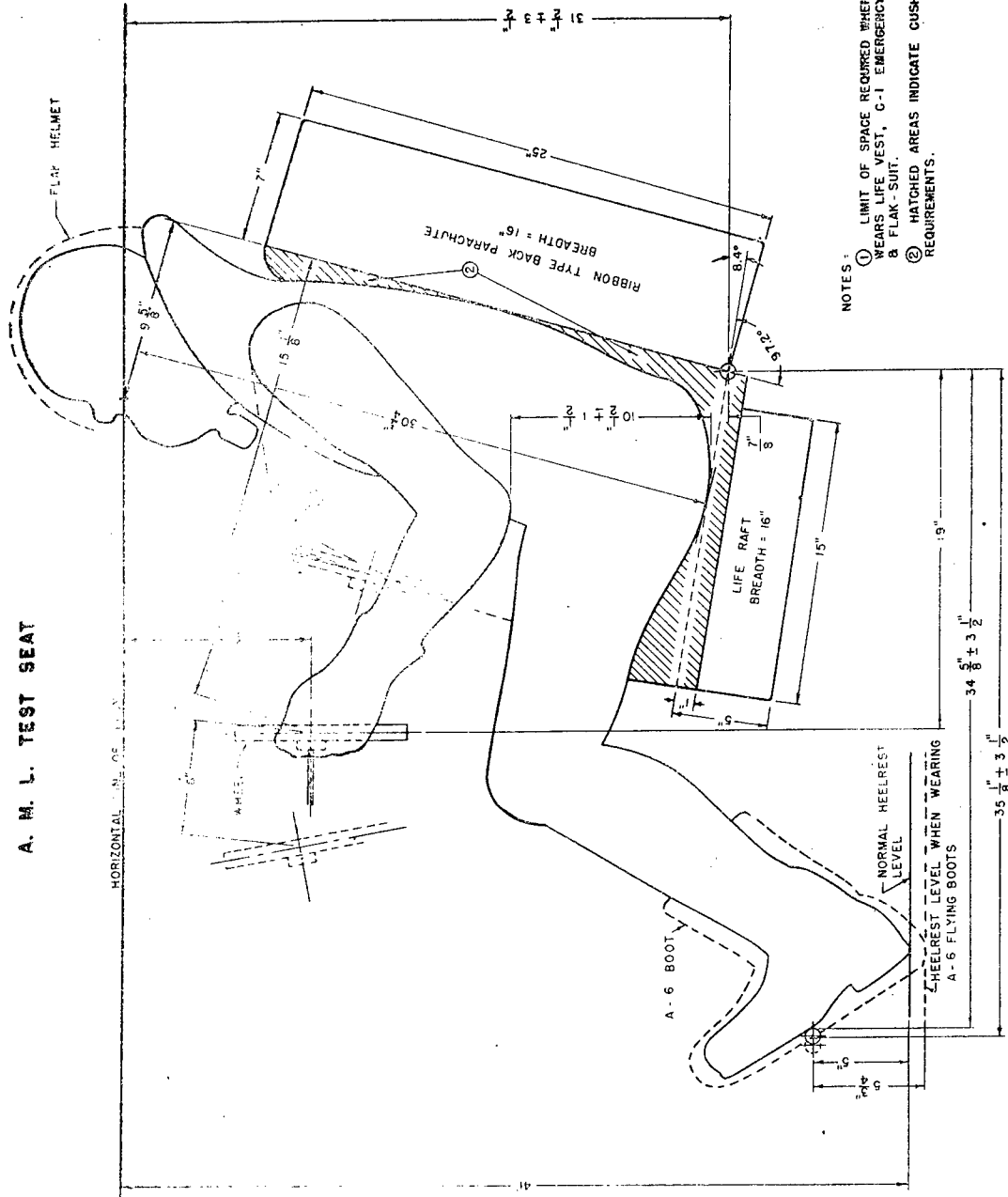

AS09 B ADL

FIGURE 1

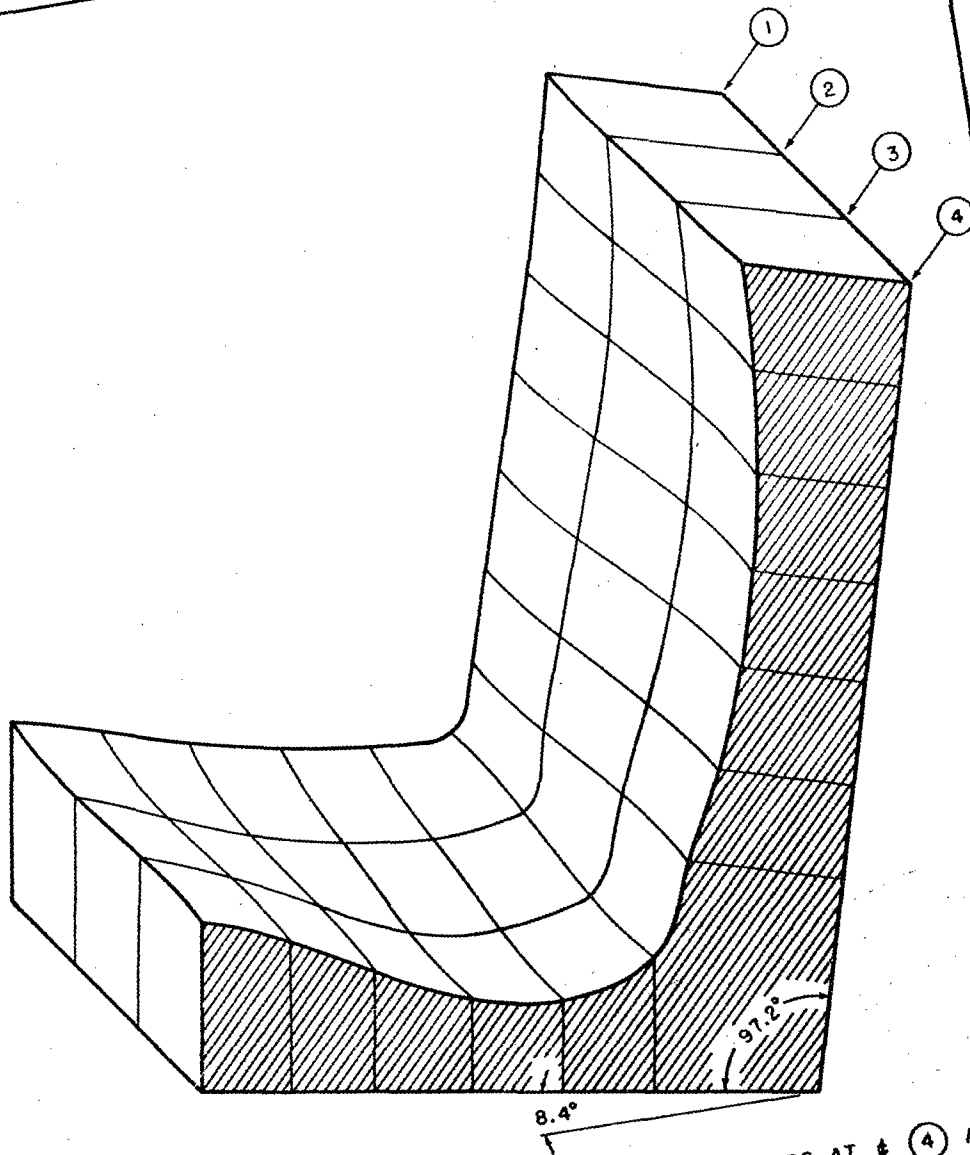

SEAT SECTION FOR 41" BOMBER COCKPIT, SHOWING PROFILES AT ④ AND
AT THREE INCH INTERVALS LATERALLY ③ - ② & ①.

4477-B. AML.

Figure IV, 19

AVERAGE POSITION OF SEAT IN 43" BOMBER COCKPIT

A. M. L. TEST SEAT

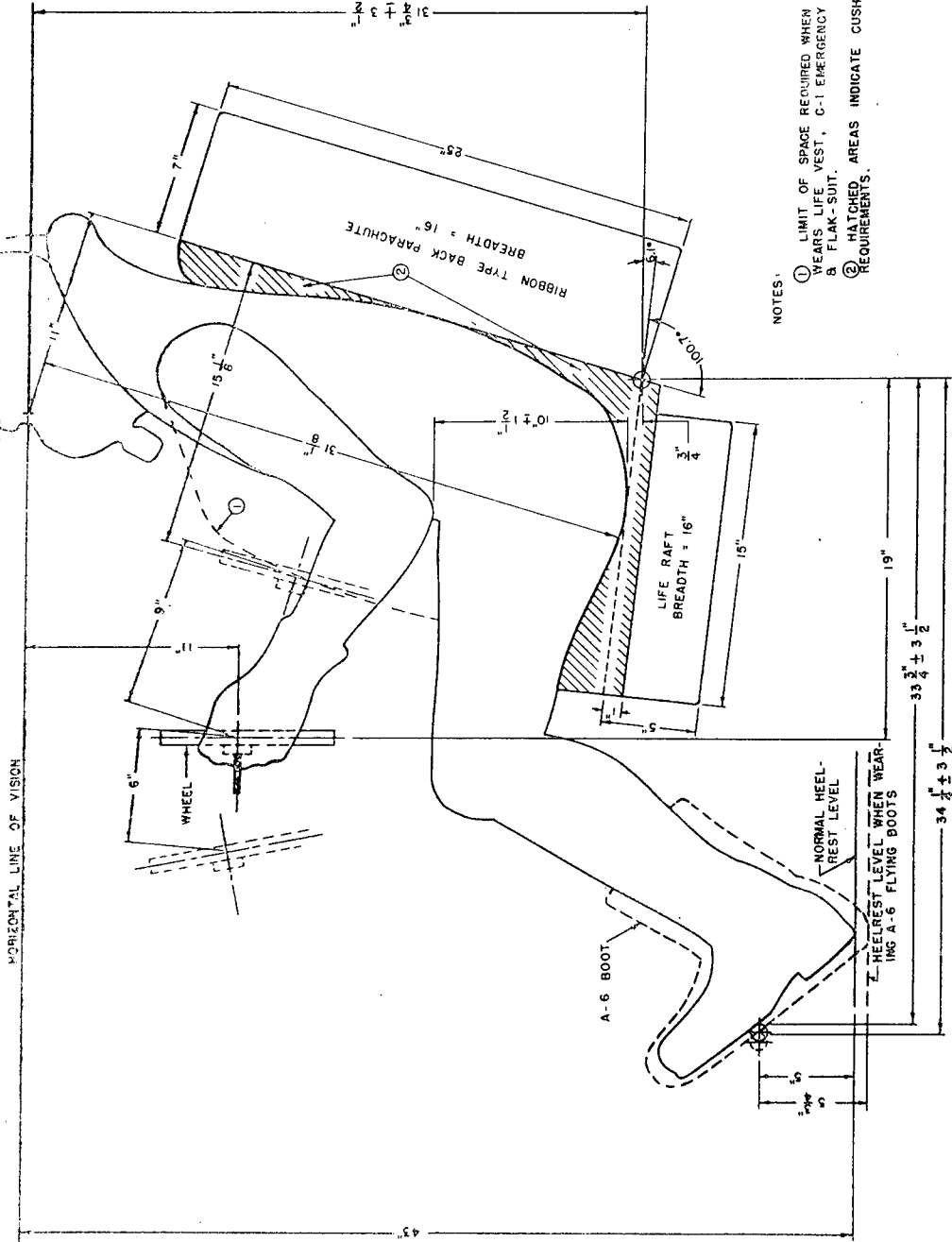

- NOTES:
- ① LIMIT OF SPACE REQUIRED WHEN PILOT WEARS LIFE VEST, G-I EMERGENCY VEST & FLAK-SUIT.
 - ② HATCHED AREAS INDICATE CUSHIONING REQUIREMENTS.

4,509 0 ASD

Figure IV, 20

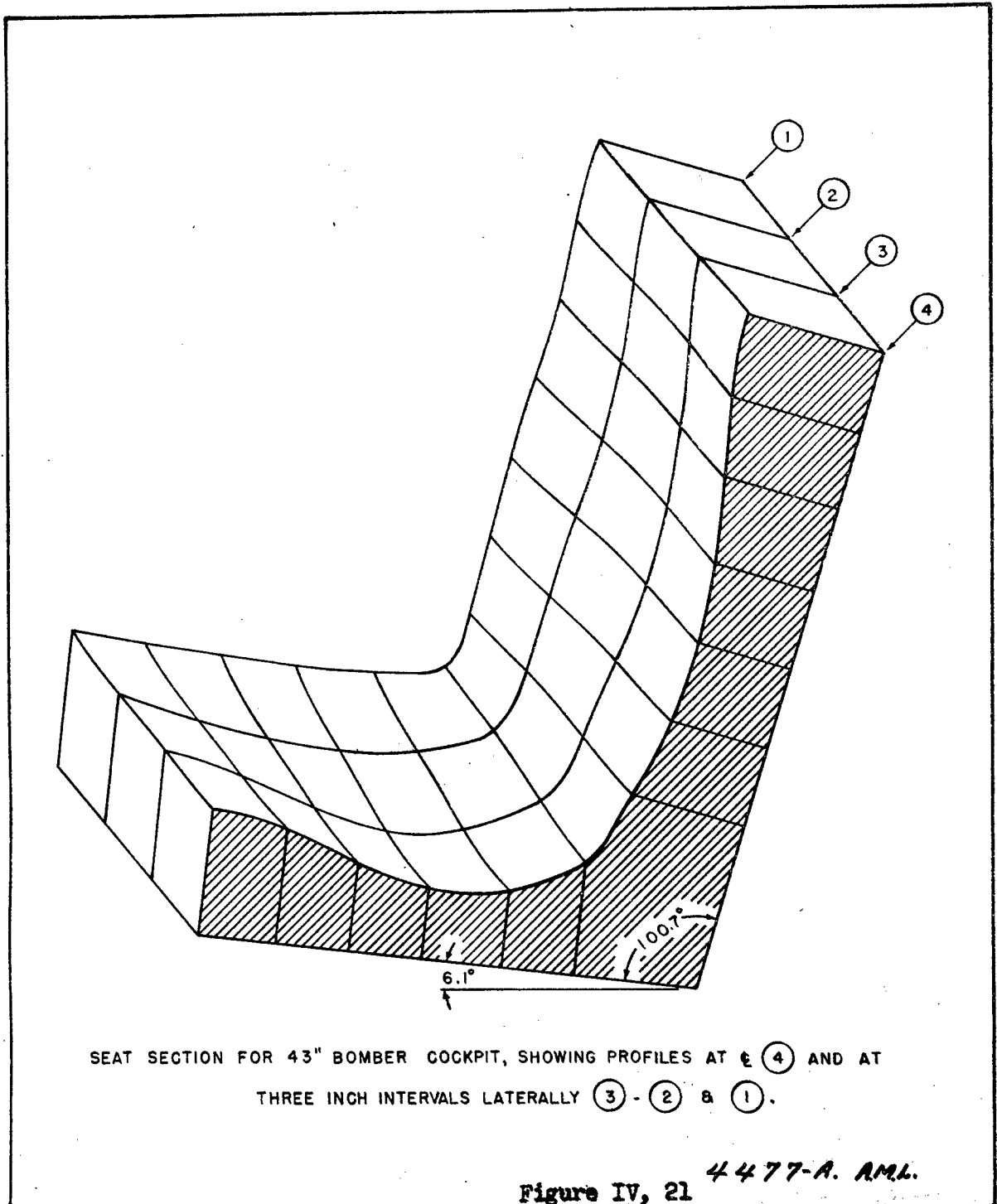

AVERAGE POSITION OF SEAT IN 46" BOMBER COCKPIT
 A. M. L. TEST SEAT

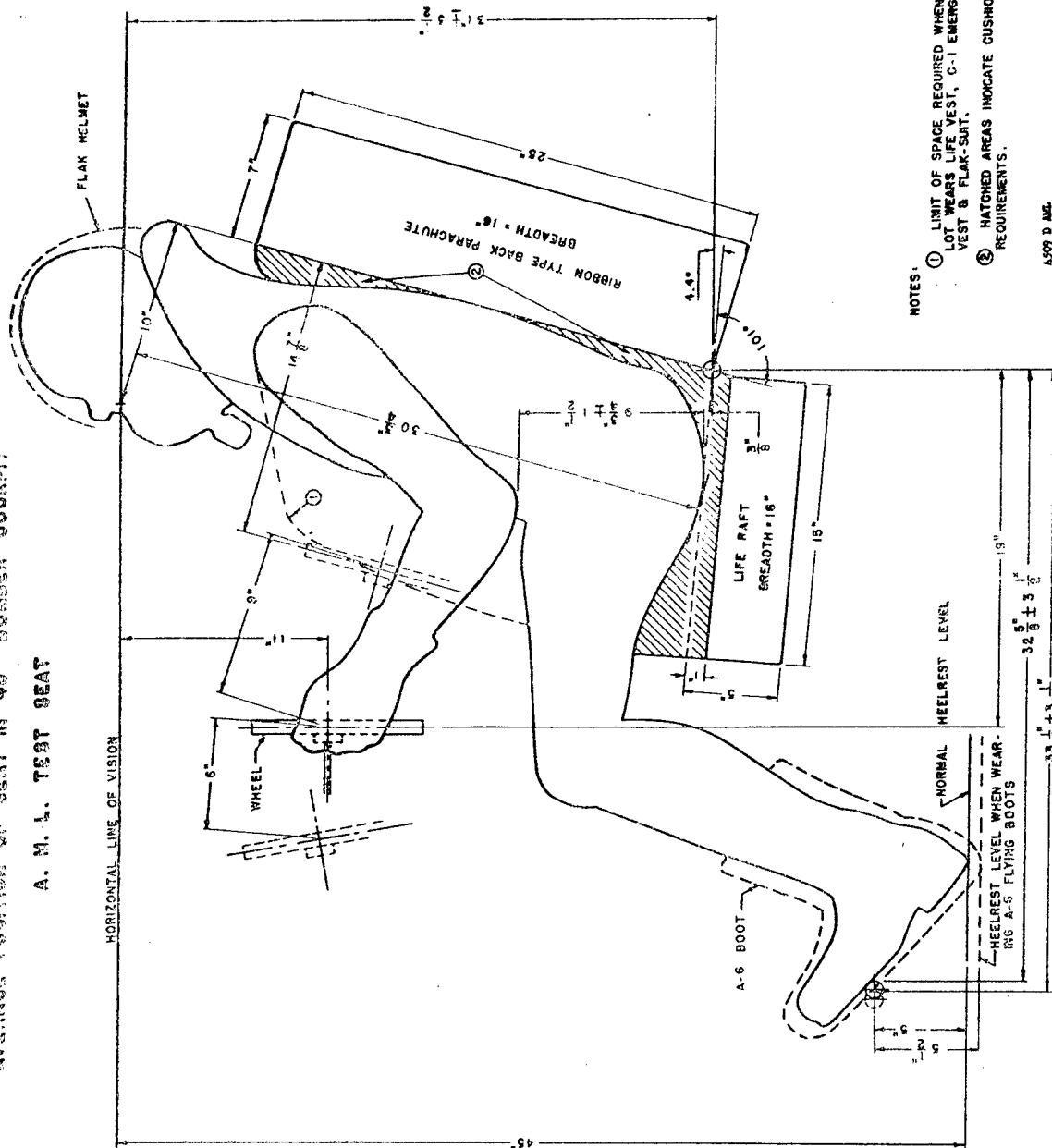

NOTES:
 ① LIMIT OF SPACE REQUIRED WHEN PILOT WEARS LIFE VEST, C-1 EMERGENCY VEST & FLAK-SUIT.
 ② HATCHED AREAS INDICATE CUSHIONING REQUIREMENTS.

AS99 D AML

Figure IV, 22

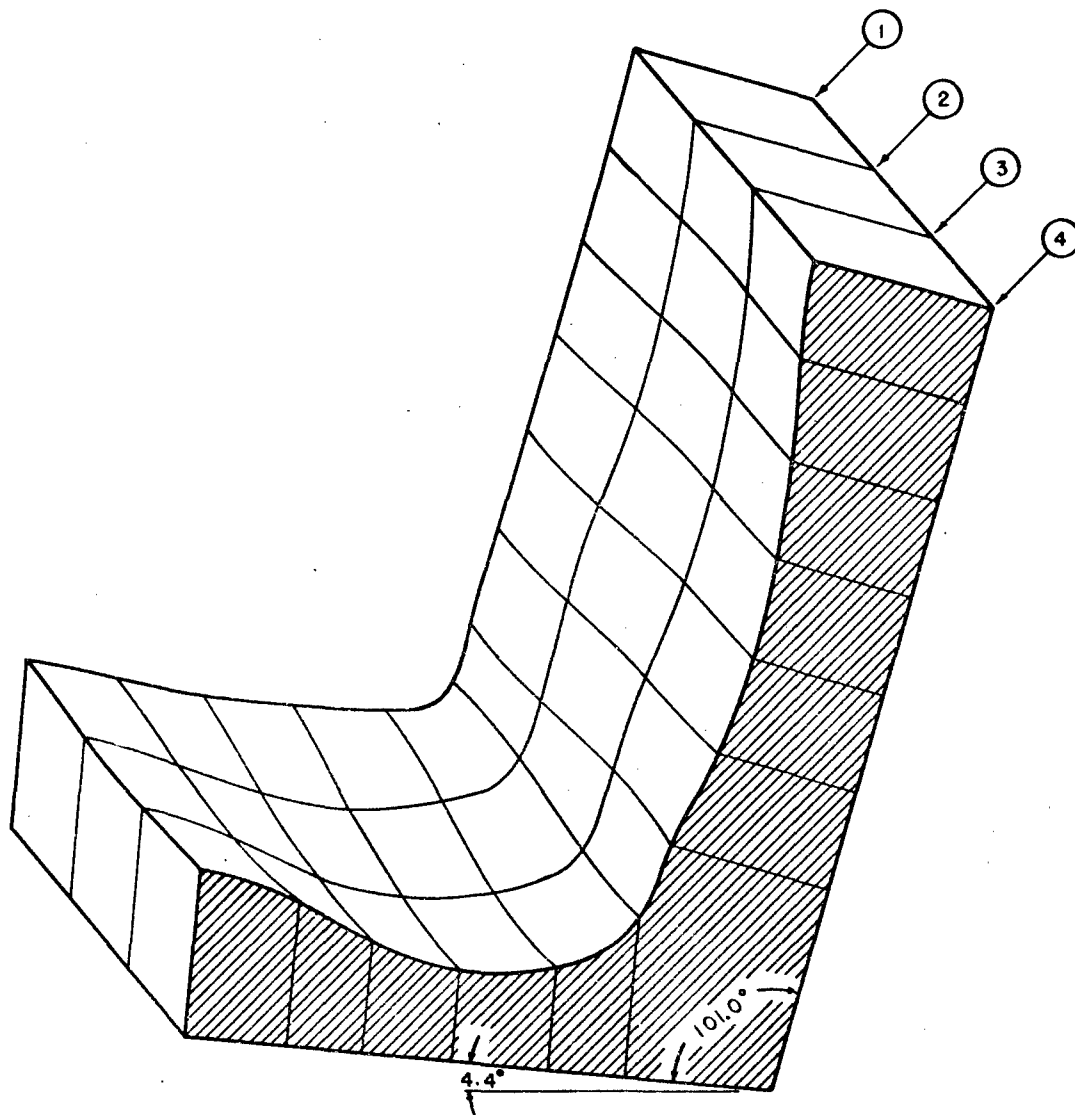

SEAT SECTION FOR 45" BOMBER COCKPIT, SHOWING PROFILES AT ϵ (4) AND AT
THREE INCH INTERVALS LATERALLY (3) - (2) & (1).

4477-AML.
Figure IV, 25

The results of studies on pilot seating in bombardment type aircraft are in theory practically identical to those demonstrated and discussed in the preceding chapter on fighter pilot seating (stick-type control), each dimension being dependent upon the cockpit level and varying in the same direction in both cases. There is one factor which enters into the latter study, however, which was of relatively minor importance in the fighter series, and that is the height of the control column. The wheel type control found currently in bombers introduces the problem here. It has been found to be the case in many bombers that the pilot either can not pull the wheel full back without practically forcing it into his lap or abdomen or, once back, does not have sufficient clearance between himself and the wheel to obtain full aileron control. This is indeed a difficult problem to solve to the complete satisfaction of all individuals because of the impracticability of incorporating any adjustability in the wheel to compensate for the fore-aft and vertical adjustability which is so practicable and desirable in the seat. It is believed that considerable improvement could be obtained through the use of a wheel which moves fore and aft in a straight line, rather than describing an arc, the straight line being perhaps pitched at approximately a five degree angle to the horizontal so that as the wheel moves back, it moves up. The cockpit drawings included herein show the most desirable position for the wheel which moves through an arc, has a chord of nine inches between its neutral and aftermost positions, has a chord of six inches between its neutral and forwardmost positions and has a wheel radius of 7-1/4 inches.

Seating and position requirements which have been determined for aircraft with the wheel-type control, when compared with the position requirements for aircraft with the stick-type control show essentially no difference in requirements for the basic dimensions beyond the realm of experimental error, except for those dimensions which are determined in part or in whole by the type of aileron-elevator control used, i.e., stick or wheel. It has been deemed feasible, therefore, to combine the values for both into a set of requirements which are common to both types of aircraft, except for those dimensions determined by the elevator-aileron control (Cf. Fig. IV, 24). Hence, the two types of aircraft are not differentiated according to function as fighter or bomber, but according to the control column, since it is the latter and not the former which determines the pilot position requirements.

In summary, it should be stated that the results of experiments indicate that a cockpit should not be a random assortment of controls, seats, and dimensions, but, rather, should be considered as a highly detailed functional system which, in order to work properly, must be carefully considered by the designer in any approaches he may make to an aircraft performance problem. Experimental data also indicate that with proper application of the data obtained it should be possible to maintain the pilot in an efficient and comfortable condition for a period of not less than eight hours, and possibly for a period as great as twelve to sixteen hours.

HUMAN DIMENSIONAL REQUIREMENTS IN AIRCRAFT COCKPITS

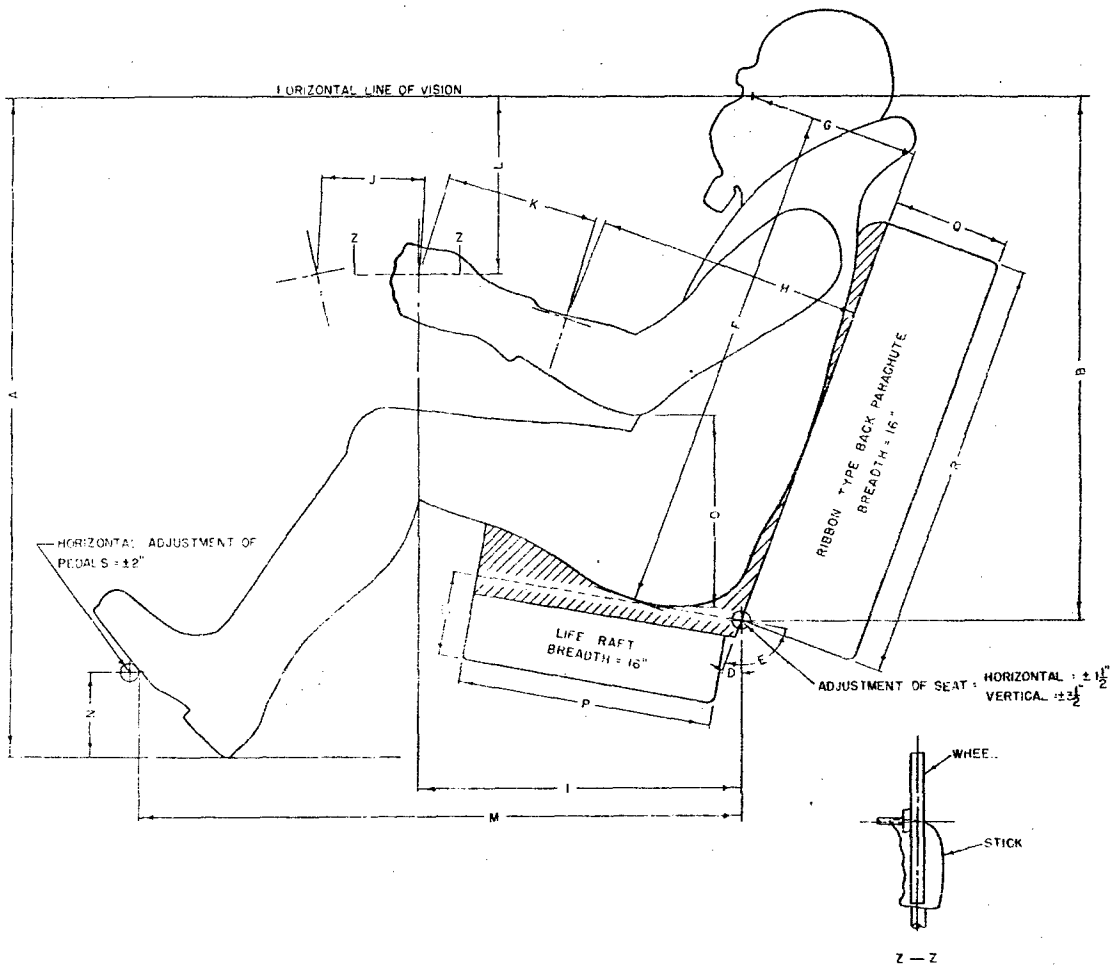

TABLE I - WHEEL TYPE CONTROL
(ALL VALUES IN INCHES UNLESS OTHERWISE NOTED)

A	B	C	D	E	F	G	H	I	J	K	L	M	N	O	P	Q	R
37	30 $\frac{1}{2}$	5	21°	101°	29 $\frac{3}{4}$	10	16 $\frac{3}{8}$	19	6	9	10	36	5	9 $\frac{1}{2}$	15	7	25
39	30 $\frac{3}{4}$	5	19°	101°	30 $\frac{1}{4}$	9 $\frac{3}{4}$	15 $\frac{3}{8}$	19	6	9	10	35	5	9 $\frac{1}{4}$	15	7	25
41	31 $\frac{1}{2}$	5	16°	101°	31	9 $\frac{3}{4}$	15 $\frac{1}{8}$	19	6	9	10	34	5	9 $\frac{3}{4}$	15	7	25
43	31 $\frac{3}{4}$	5	16°	101°	31 $\frac{1}{2}$	10	15 $\frac{1}{8}$	19	6	9	11	34	5	9 $\frac{3}{4}$	15	7	25

TABLE II - STICK TYPE CONTROL
(ALL VALUES IN INCHES UNLESS OTHERWISE NOTED)

A	B	C	D	E	F	G	H	I	J	K	L	M	N	O	P	Q	R
37	30 $\frac{1}{2}$	5	21°	101°	29 $\frac{3}{4}$	10	14 $\frac{1}{2}$	19	6	9	11 $\frac{1}{2}$	36	5	9 $\frac{1}{4}$	15	7	25
39	30 $\frac{3}{4}$	5	19°	101°	30 $\frac{1}{4}$	9 $\frac{3}{4}$	13 $\frac{3}{4}$	19	6	9	13 $\frac{3}{4}$	35	5	9 $\frac{1}{4}$	15	7	25
41	31 $\frac{1}{2}$	5	16°	101°	31	9 $\frac{3}{4}$	13 $\frac{1}{2}$	19	6	9	15 $\frac{1}{2}$	34 $\frac{1}{2}$	5	9 $\frac{1}{4}$	15	7	25
43	31 $\frac{3}{4}$	5	16°	101°	31 $\frac{1}{4}$	10	13	19	6	9	17 $\frac{1}{2}$	34 $\frac{1}{2}$	5	9 $\frac{1}{4}$	15	7	25

Figure IV. 24

THE CENTER OF GRAVITY OF THE SEATED FIGHTER PILOT

As the performance of aircraft reaches higher and higher levels, and as the consideration of the safety of the crew merits more and more attention, it becomes highly important that some consideration be given to the definition of the location of the center of gravity of the pilot. This is particularly true in high-performance fighters. If the structure of the seat is to be properly fabricated so as to gain the maximum strength to protect the man, it must incorporate the engineering features associated with the location of the man's CG.

By placing a series of individuals into the seated attitude which is maintained by fighter pilots in their craft, Figures IV, 25; IV, 26, and then by the simple method of balancing the body in two different positions, with the verticals through the points of balance intersecting, this center of gravity may be attained. It may be done photographically as shown in the figures, with the two negatives superimposed so as to produce a permanent record of the man's position.

Inasmuch as a mock-up is required to hold the man in position, a correction formula is used to eliminate the mock-up factor itself.

$$(A) \text{ Distance Seat}_{cg} \text{ to Seat-plus-Man}_{cg} = \frac{\text{Weight of Man (WM)}}{\text{Weight of Seat (WS)}}$$

$$(B) \text{ Distance Seat-plus-Man}_{cg} \text{ to Man}_{cg} = \frac{\text{Weight of Man (WM)}}{\text{Weight of Seat (WS)}}$$

$$B = \frac{WS}{WM \times A}$$

The final location of the center of gravity of the man is then A + B distance from the center of gravity of the seat-plus-man.

The average position of the CG is 11.60 inches vertically from the back of the seat and 10.46 inches vertically from the seat itself. The range in position from the back of the seat was found to be from 11.05 to 12.74 inches, and the range from the seat itself, 8.90 to 12.42 inches, showing a fairly constant position in the relative horizontal, but a variation vertically tied in with stature variation. The lower values vertically correspond to lower statures. The average position is based on a stature of 69.4 inches and a body weight of 163 pounds with light clothing.

No consideration has been given to the effects on the center of gravity due to personal equipment, since the respective CG's of items of equipment can be determined independently and the final position of the center of gravity of the entire system calculated.

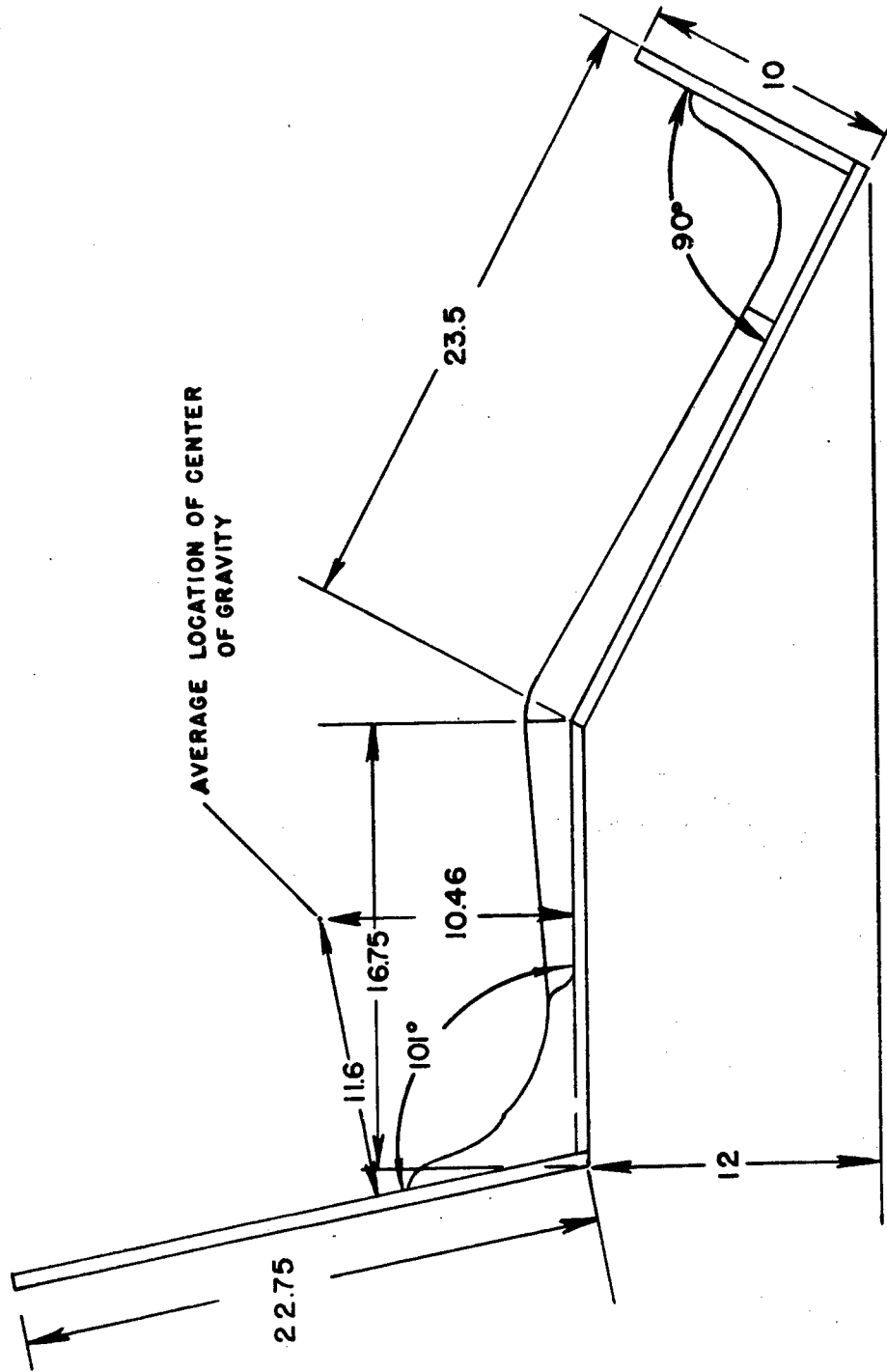

SCALE $\frac{1}{8}$: 1 INCH

Mock-up for Determining the Center of Gravity
4404B-AML

Figure IV, 25.



Figure IV, 26.

BODY SIZE CONSIDERATIONS FOR EJECTION SEATS

In fighter-type aircraft, and possibly in certain type of heavier planes, it must be kept in mind that speeds in excess of three hundred and fifty miles per hour render emergency escape very dangerous, and consideration must be given to the provision of ejection of the man under some form of power other than his own. The Germans attained this by providing a charge of powder which would eject both the seat and the man, following which the man could release the seat and proceed through the ordinary parachute maneuvers.

Attempts have been made to modify existing aircraft in such a manner as to incorporate installation of an ejection-type seat, but it has been found extremely difficult to gain fully satisfactory means. Therefore, the designer should make every effort to incorporate the full installation for his aircraft before the mock-up stage is reached.

The primary requisite for the consideration of the human body as it relates to the cockpit is the degree of assurance which can be guaranteed for the positioning of the body in the seat. A definite example will serve to demonstrate this point.

In the type of seat figured, it will be seen that the toes of the feet serve to define the maximum requirement. The position of the instep in relation to the hip will also define the extent of radius through which the thigh must go to attain a fixed position. It may be that lower dimensional requirements might be attained if pans rather than stirrups could be provided, perhaps holding the toes down and back from their present position. However, the degree to which this could be attained will be determined by the clearances offered when the seat is at full-down adjustment. In addition, if there is a possibility that the feet might slip off the stirrups, the thighs might very well be describing a radius as the knees pass the windshield, and thereby present a maximum dimensional requirement of about 28 inches, even with the feet falling farther back.

There are certain aerodynamic requirements which must be considered if deviations from the 13° angle used by the Germans on this particular seat are indicated. They went to great length to design the head rest in such a manner as to protect the face in the slip-stream, and it will be seen from the figures that the relative position of this head rest will change from a position somewhat in line with the top of the head of a tall man, down to a position about level with his ears if the angle of ejection is dropped back to 30° from the vertical. If the ejection angle should be this great, the head rest must be elongated and this elongation may require such an increase in the sitting position of the seat structure, at 13° , that it will be too long to fit under the canopy of the aircraft.

If ejection at angles in excess of 13° is considered, the man must be moved from the 13° back to the ejection angle, requiring time. If he is not moved back, but stays at the 13° while ejection is occurring, then the difference in angles may be sufficient to apply transverse "g" to the man's head and produce instability

in amounts great enough to break the neck. A small difference may be inconsequential, but extreme care should be taken to insure this before full installation is considered.

Frontal areas must also be considered in relation to the angles of ejection and the trajectories which must be maintained to clear the rudder. Figure IV, 27. The total frontal area drops from 5.0 sq. ft. at 13° down to 4.5 sq. ft. at 30° , so may offer some advantage to compensate for the lower trajectory inherent in ejection at the 30° angle.

Finally, in consideration of frontal areas, it is absolutely imperative that no less than 25 inches be provided laterally for clearances at the shoulders and elbows.

43750 AML

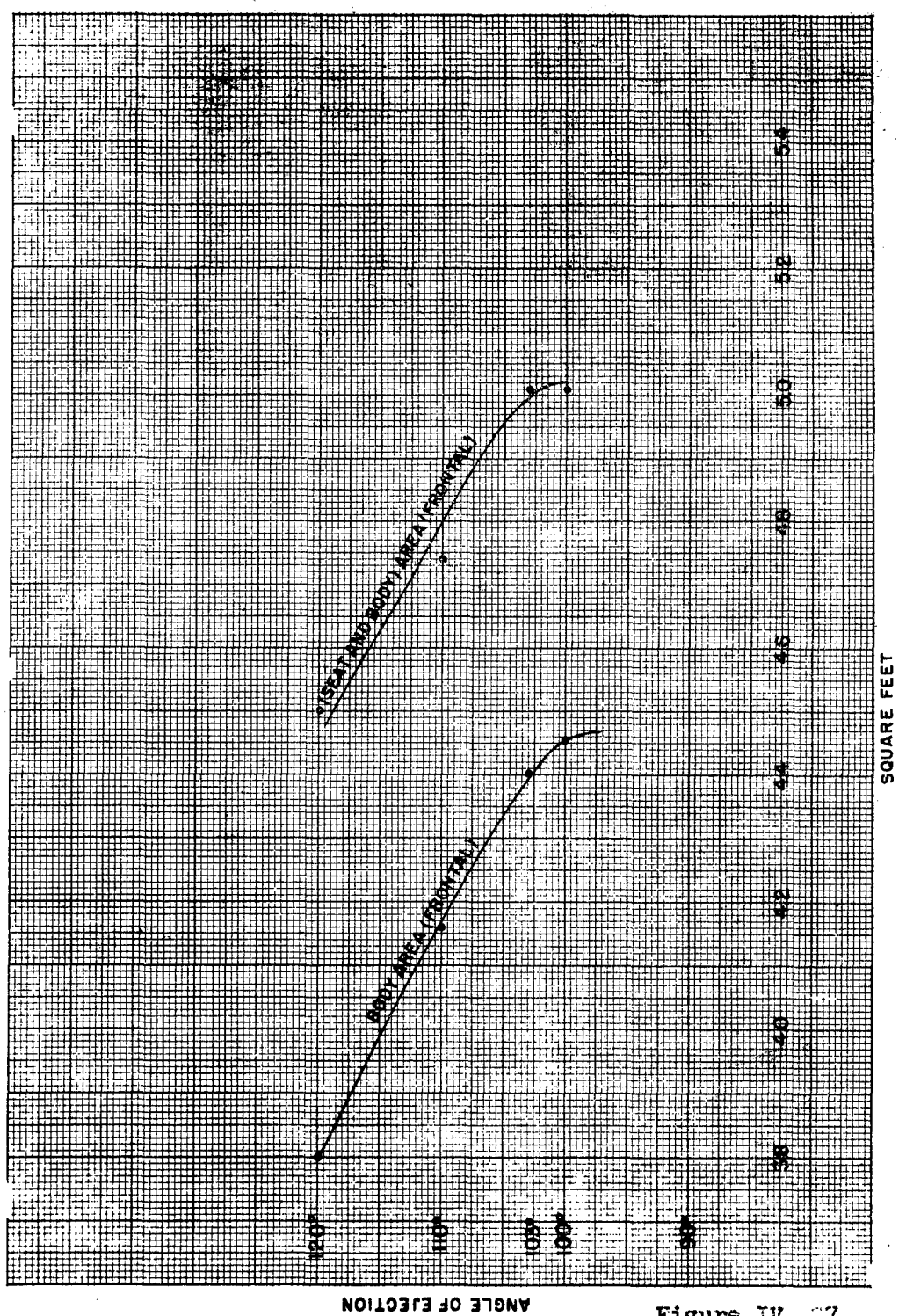

ANGLE OF EJECTION

Figure IV, 27.

HUMAN DIMENSIONAL REQUIREMENTS FOR CATAPULT EJECTION
(AERO MED. LABORATORY)

ELBOW BREADTH - 22"

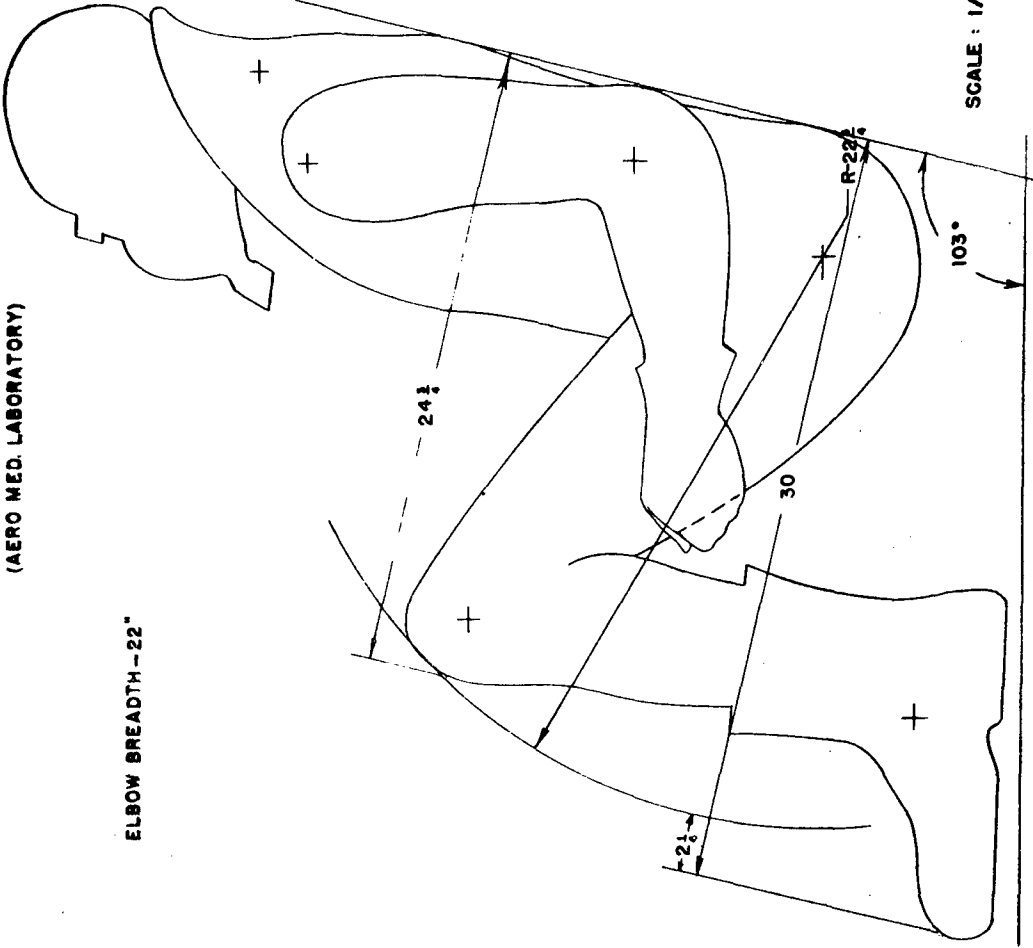

SCALE: 1/8

Figure IV, 28.

HUMAN DIMENSIONAL REQUIREMENTS
FOR CATAPULT EJECTION IN GERMAN TYPE CATAPULT SEAT
(AERO MED. LABORATORY)

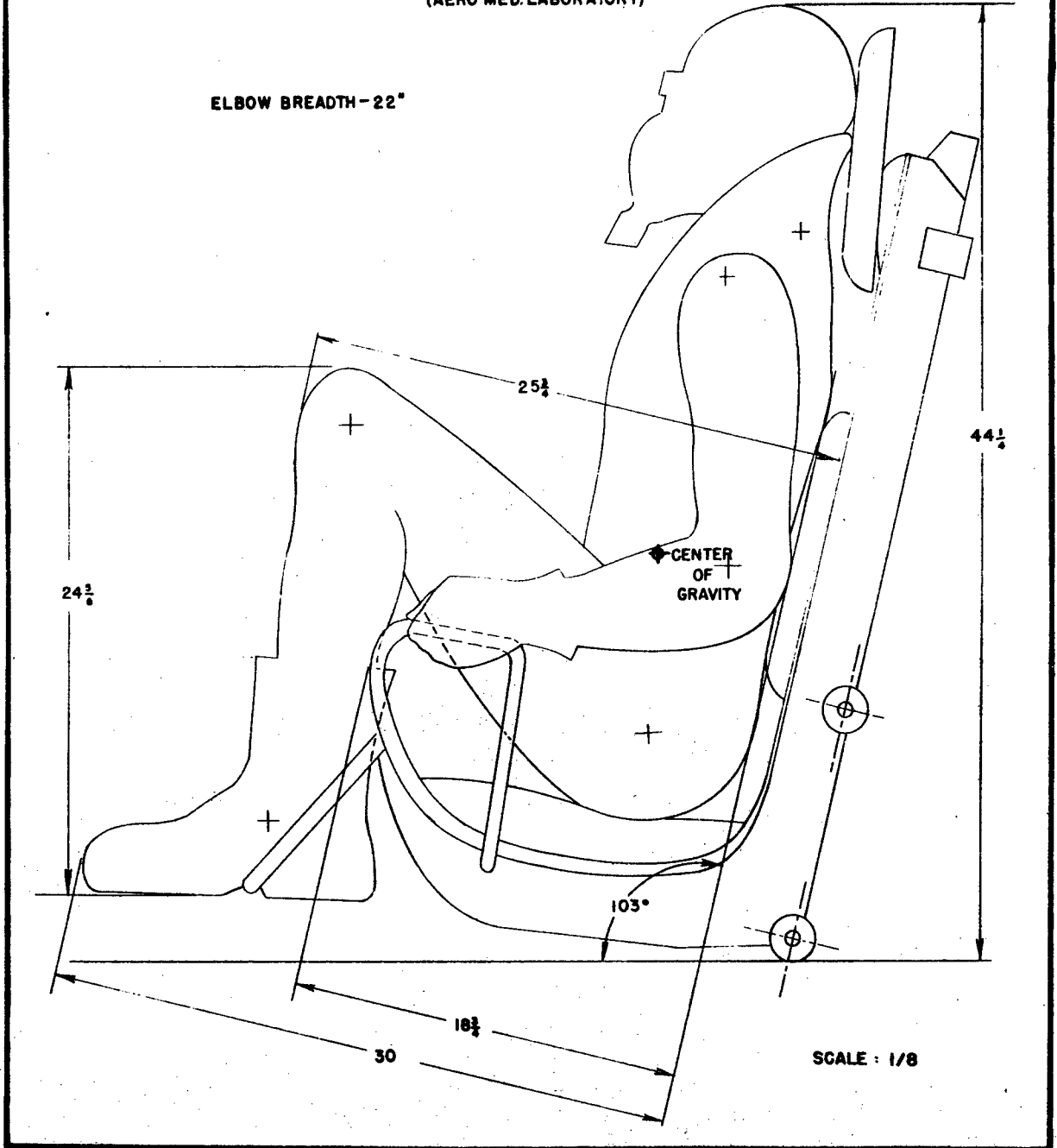

Figure IV, 29.

HUMAN DIMENSIONAL REQUIREMENTS FOR CATAPULT EJECTION
IN GERMAN TYPE EJECTION SEAT
(AERO MED. LABORATORY)

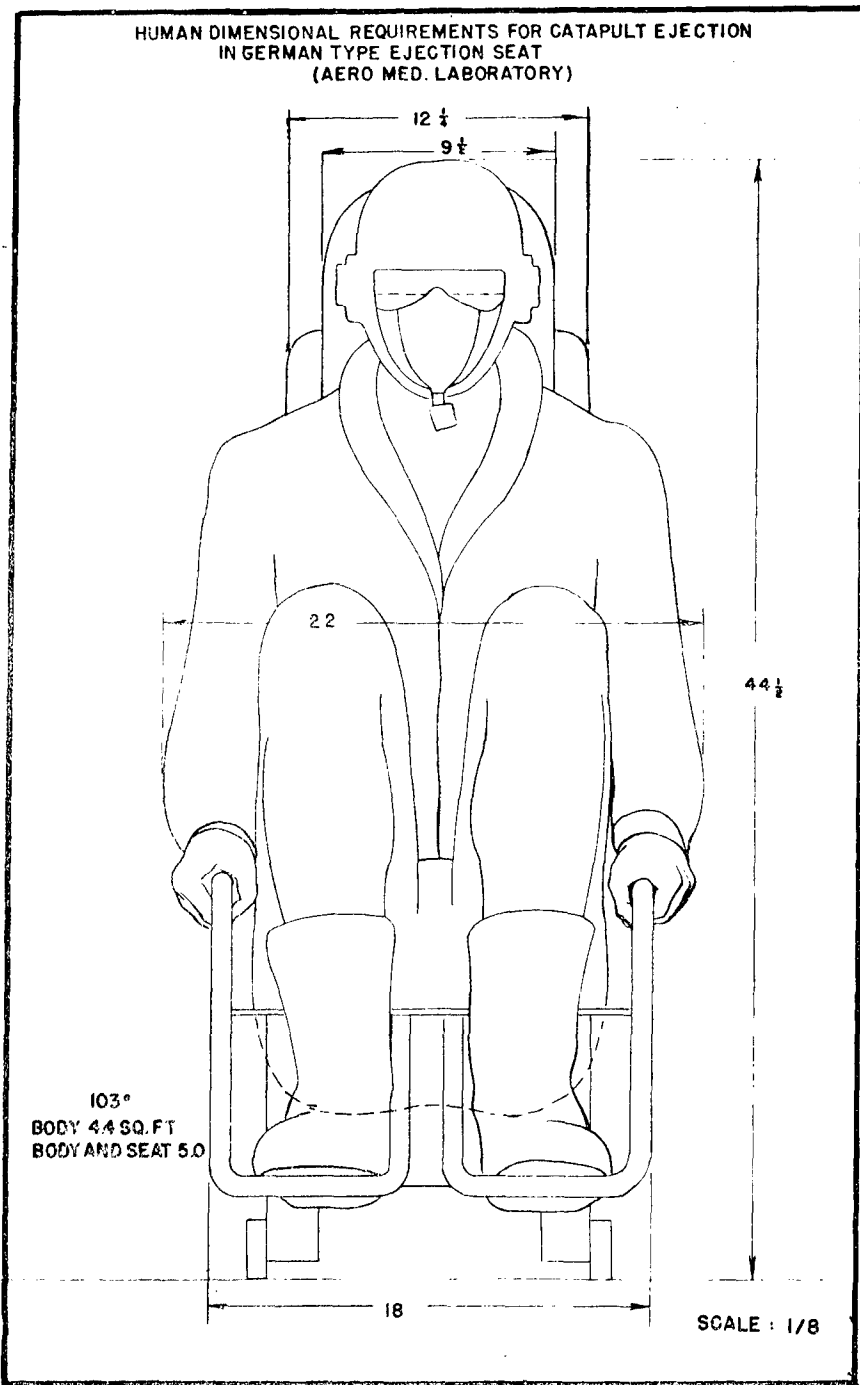

Figure 17, 30

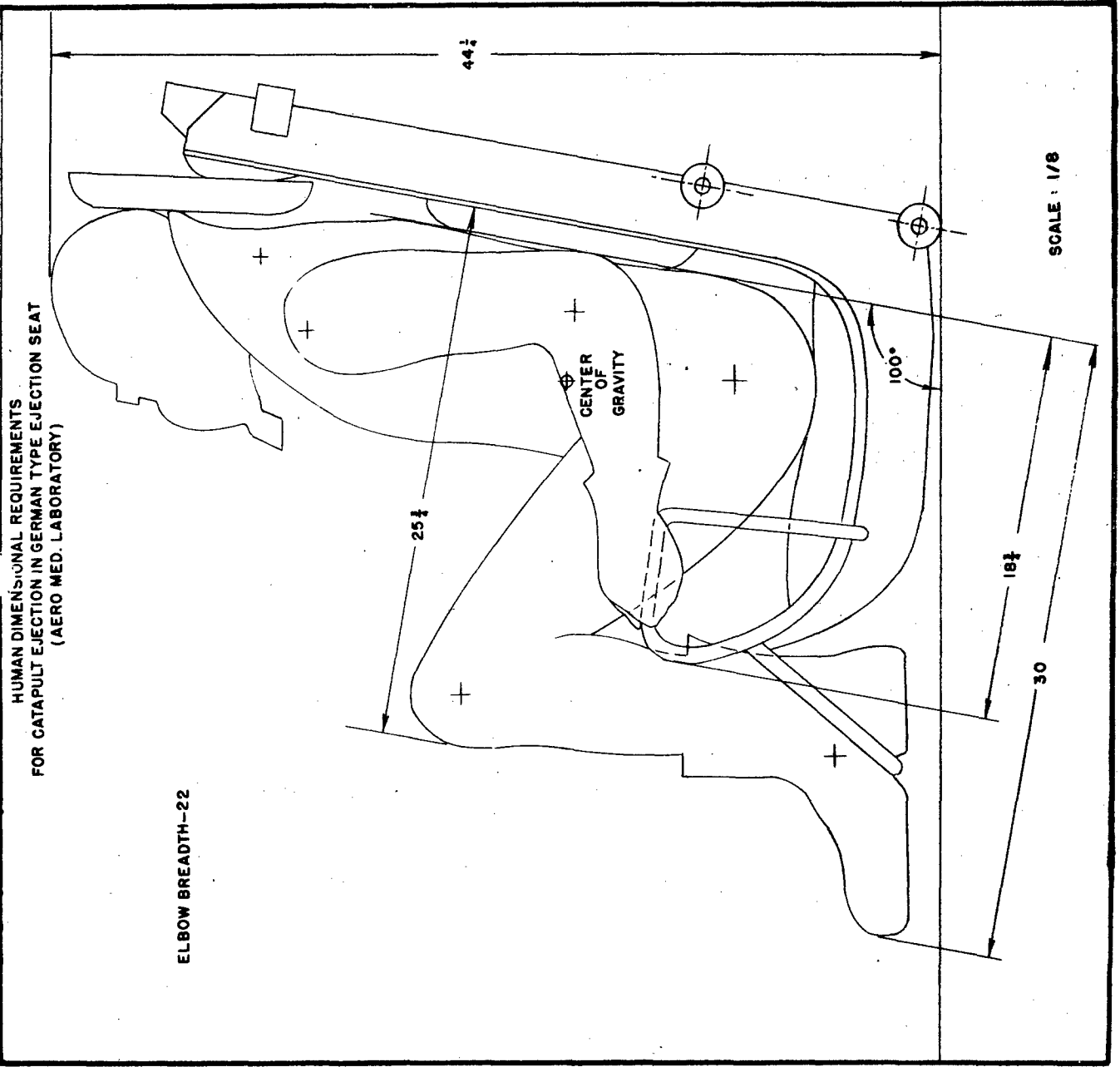

Figure 17, 31.

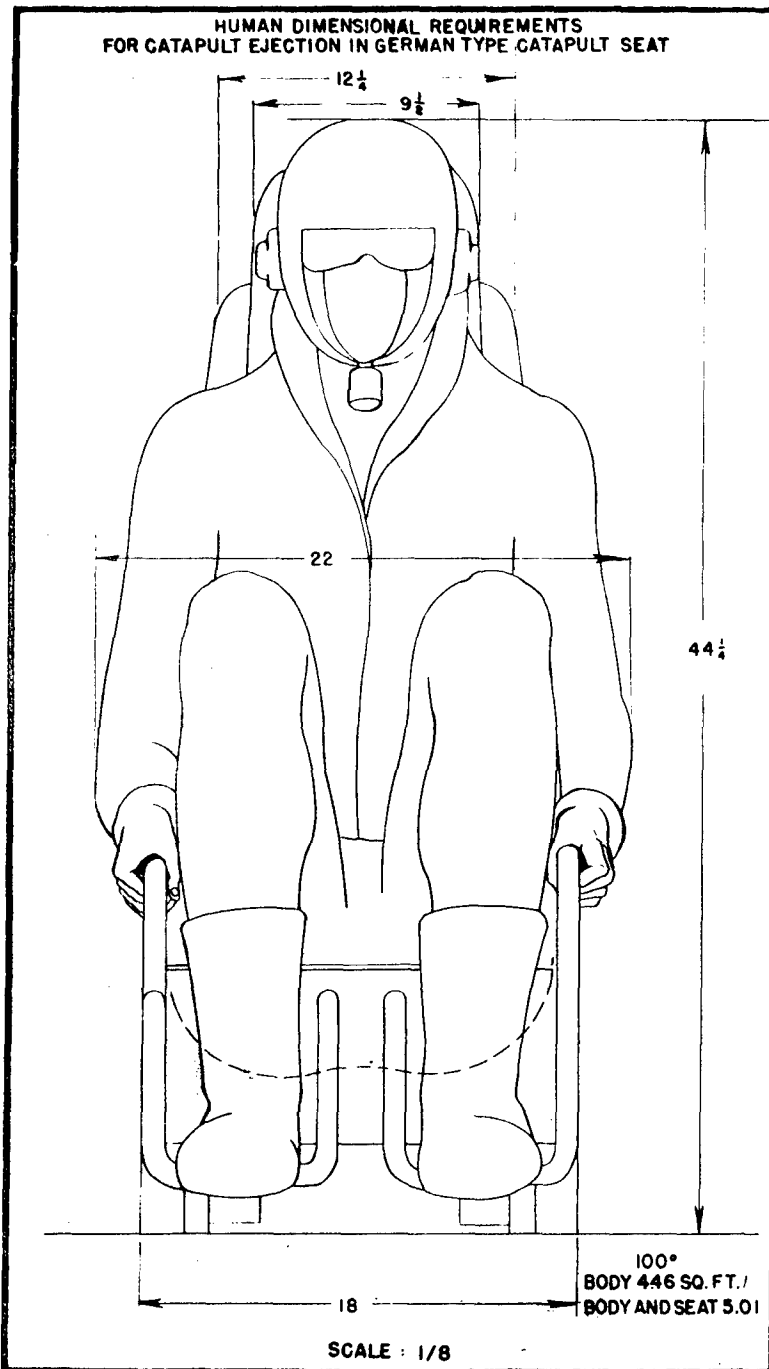
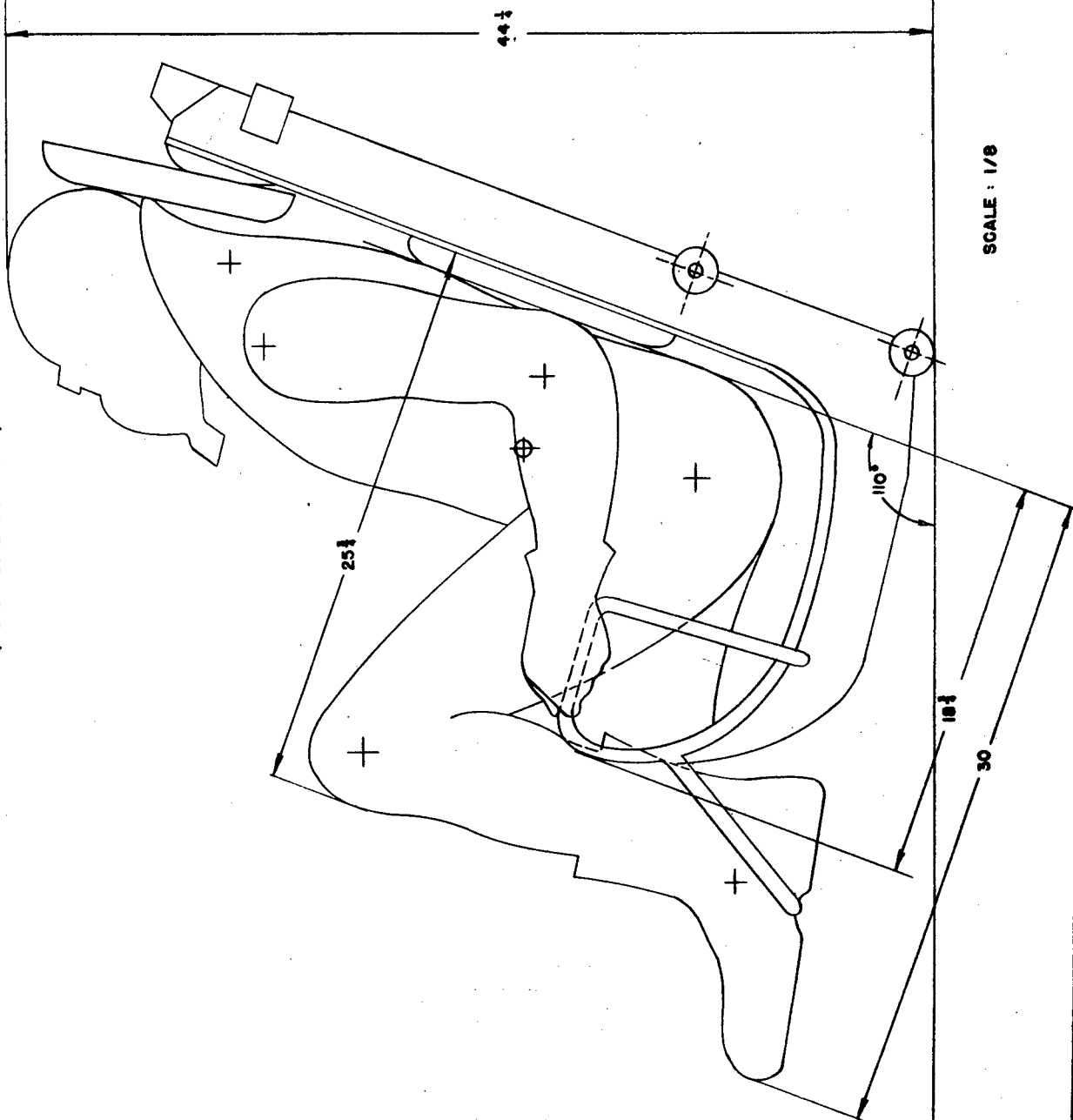

Figure IV, 32.

HUMAN DIMENSIONAL REQUIREMENTS FOR CATAPULT EJECTION
IN GERMAN TYPE EJECTION SEAT
(AERO MED. LABORATORY)



SCALE : 1/8

Figure IV, 33.

HUMAN DIMENSIONAL REQUIREMENTS FOR CATAPULT EJECTION
IN GERMAN TYPE EJECTION SEAT
(AERO MED. LABORATORY)

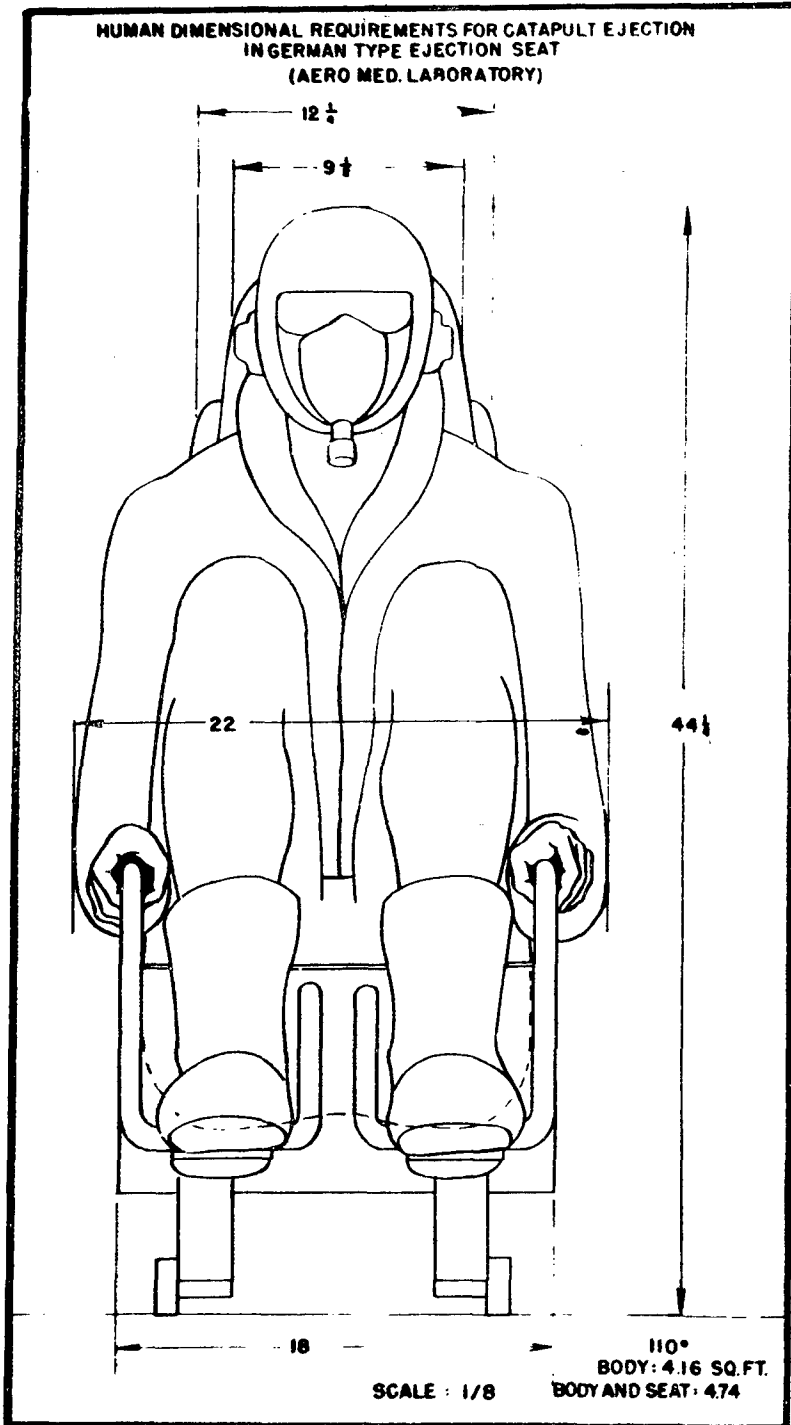

Figure 17, 34.

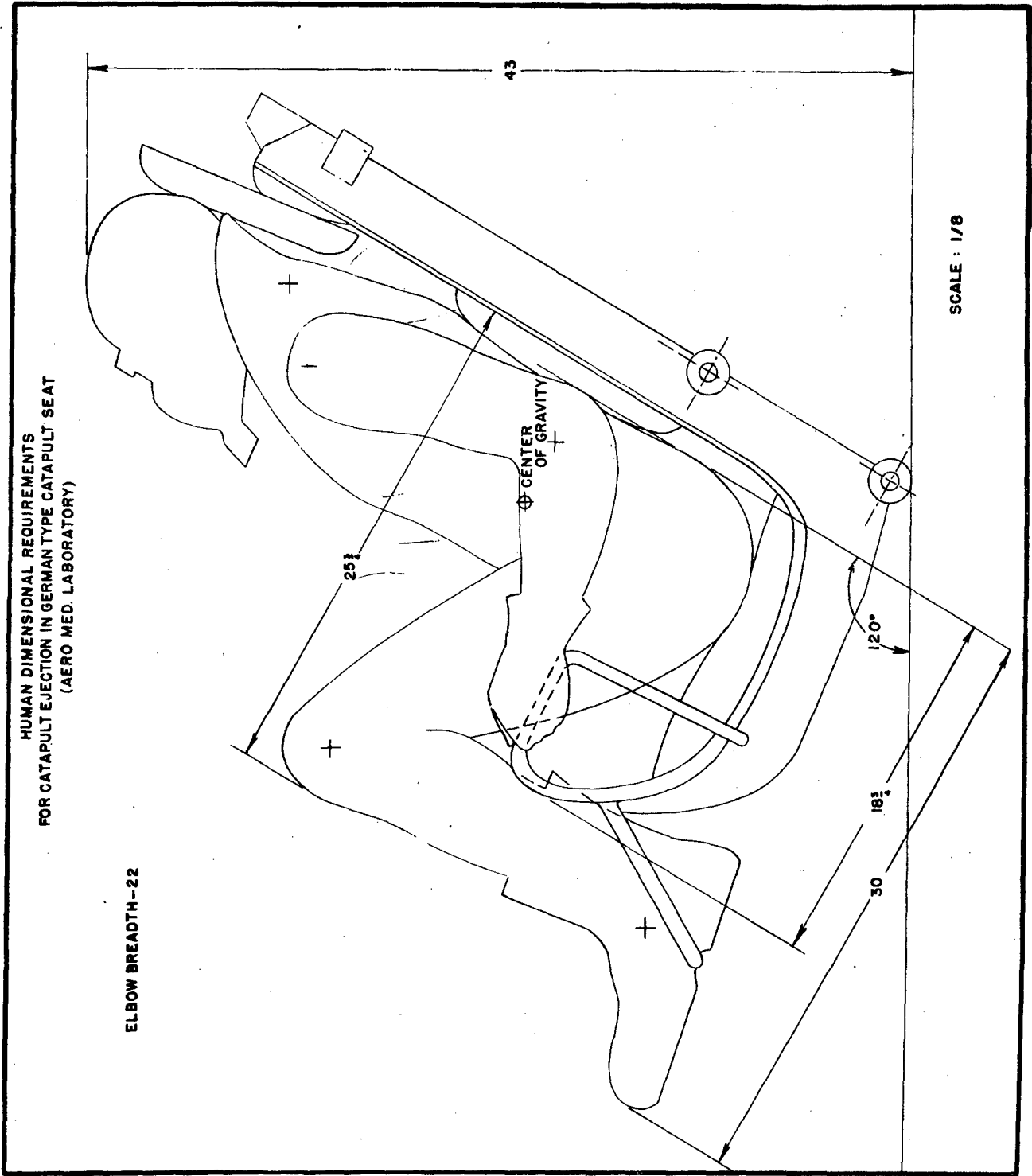

Figure 17, 35.

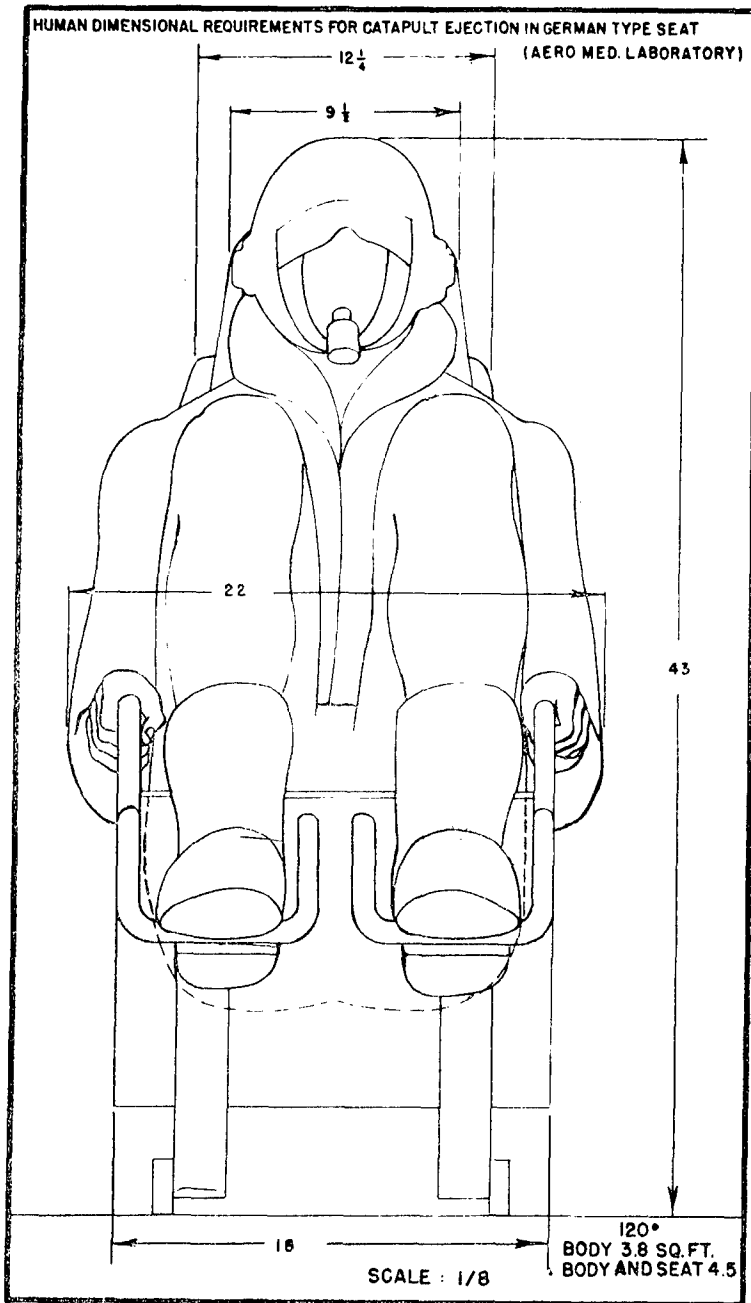

Figure IV, 36.

407-1000

PRONE POSITION

The first airplane flight in history was made in the prone position. Since that time considerable research work has been done in various countries on the operational possibilities of such a use of the pilot. There are many disadvantages which may or may not be outweighed by the advantages.

From the poor standpoint, the position represents a radical departure from that to which the modern pilot has been trained. It offers a frontal field of vision which is somewhat lower in angle than that encountered in the modern attitude. There has been some doubt as to whether this field is adequate enough for modern combat conditions and techniques. However, with higher performances to be expected in new interceptor aircraft, with radar pick-up, and possibly with radar controlled guns, the pilot's visual field, so far as combat is concerned, may become less and less important.

Beyond these two disadvantageous factors, there are several on the credit side which should be given consideration.

First, the pilot is in a position which is actually normal, psychologically, for flight attitudes, contrary to his previous training. Second, this position enables the man to withstand "g" forces possibly as high as 15, and perhaps even higher. Certainly he cannot stand this value in any position approaching the upright posture. Thirdly, there are certain advantages which should be considered from crash safety aspects, inasmuch as the glide angle of a powerless aircraft, under control, would give the man an effective "g" somewhat transverse to the long axis of the body. Finally, the variation from the modern visual fields may or may not be of great importance, as mentioned above.

Because of these long time considerations, it is worthwhile to record the data which have been derived from studies on the prone position. First, the tolerances to provide for various statures can actually be more easily accommodated in this type of installation than in the conventional one. The adjustments required are those located in the foot pedals, which will automatically determine the stature of pilot to be accommodated. If, for example, 6" of pedal adjustment are installed, right away it is known that a 6" variation in stature may be utilized. Weight considerations, however, may limit this consideration from the lateral aspect. Figure IV, 37, shows the adjustment required in the general aspect and Figure IV, 38, shows how visual fields will vary with different amounts of chest rises and body sizes. The usual amount of attention which should be given to body size will easily accommodate adequate ranges of body sizes.

Another consideration from the comfort standpoint is that related to the normal position which the feet attain while the pilot is lying in a nearly horizontal plane. The position is shown in Figure IV, 39, and the average resting angle is 21° back of the vertical; with total dorsiflexion 33° forward of the resting angle, and dorsiextension 21° aft.

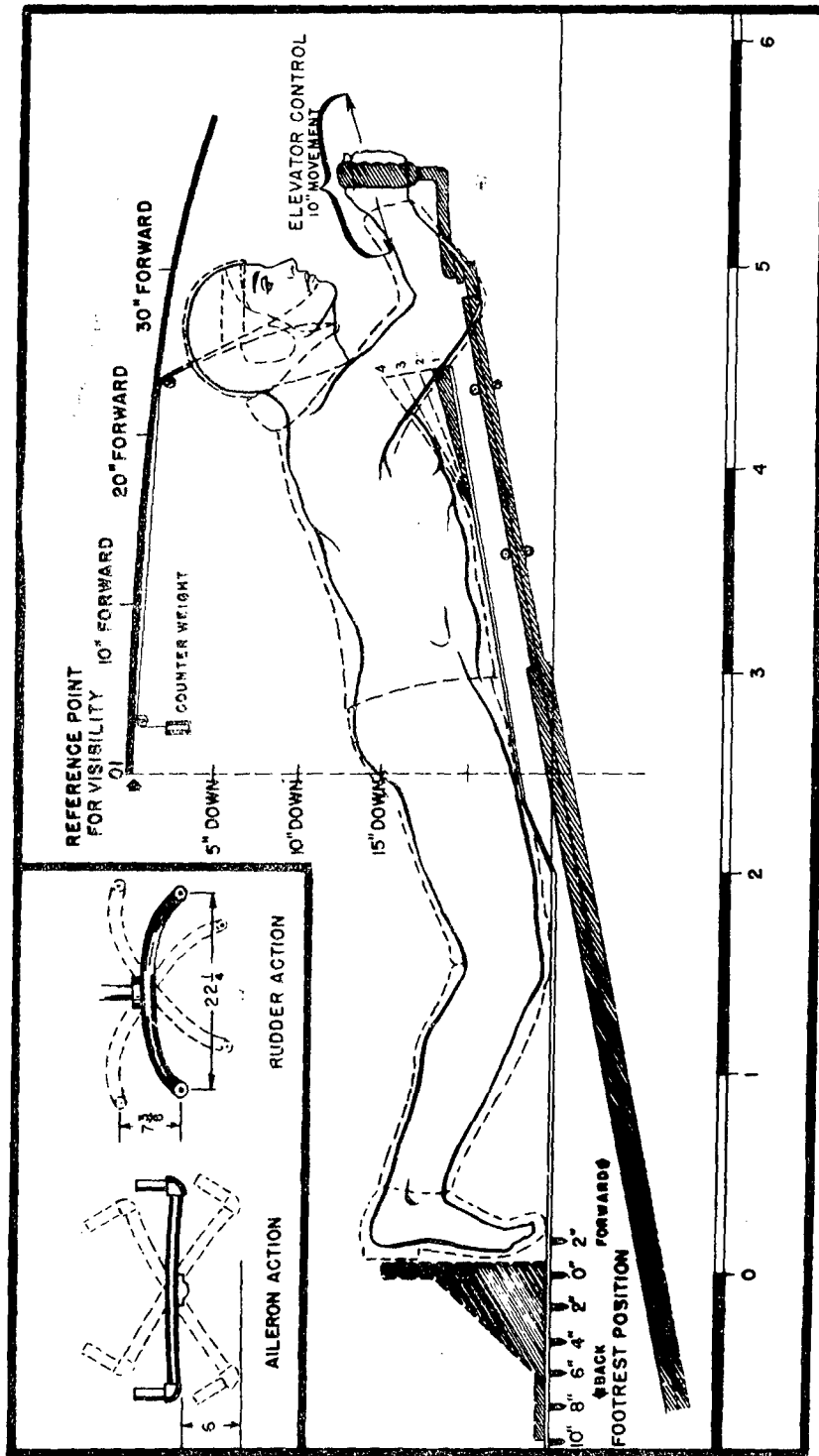

4375-Q AML

Figure IV, 37.

AREAS NOT AVAILABLE TO VISION

NO. 1 DUE TO POSITION OF INDIVIDUAL

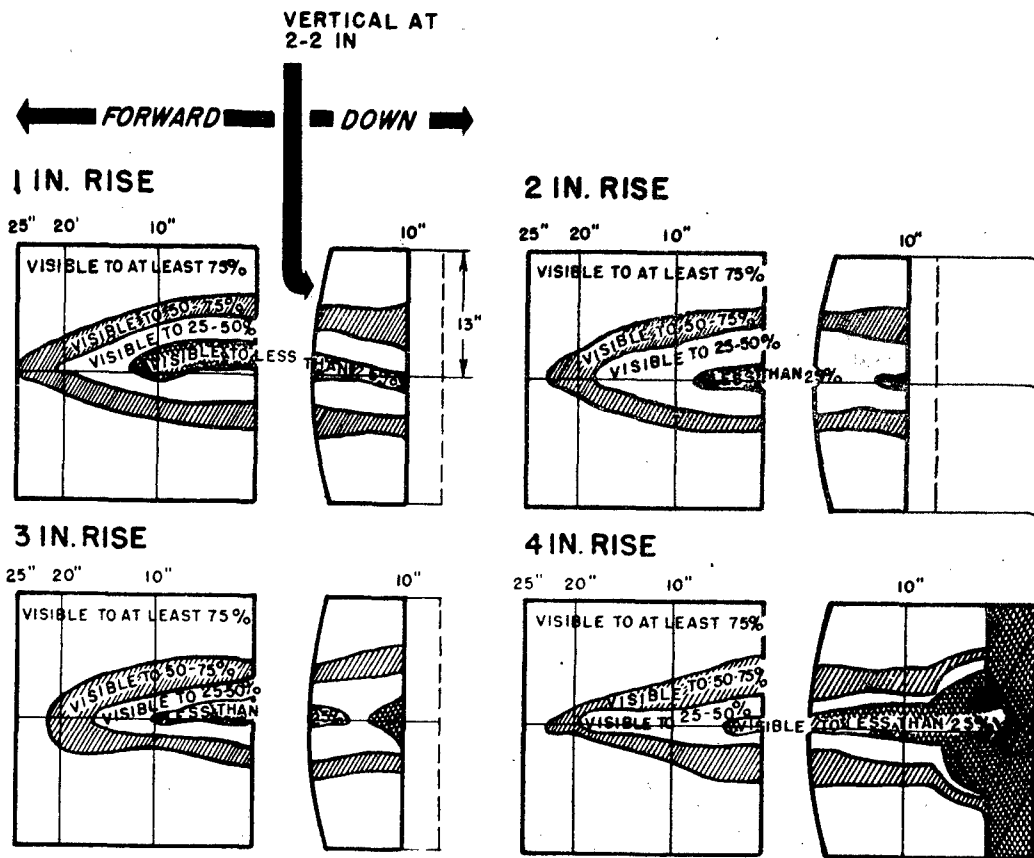

NO. 2 DUE TO SIZE OF INDIVIDUAL

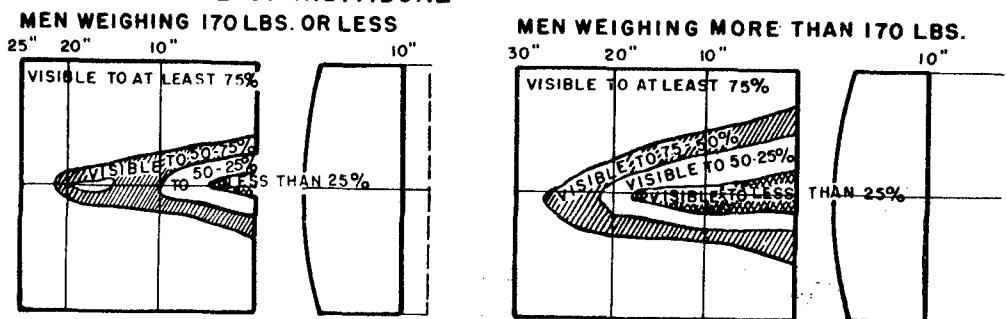

Figure IV, 38.

4375 R

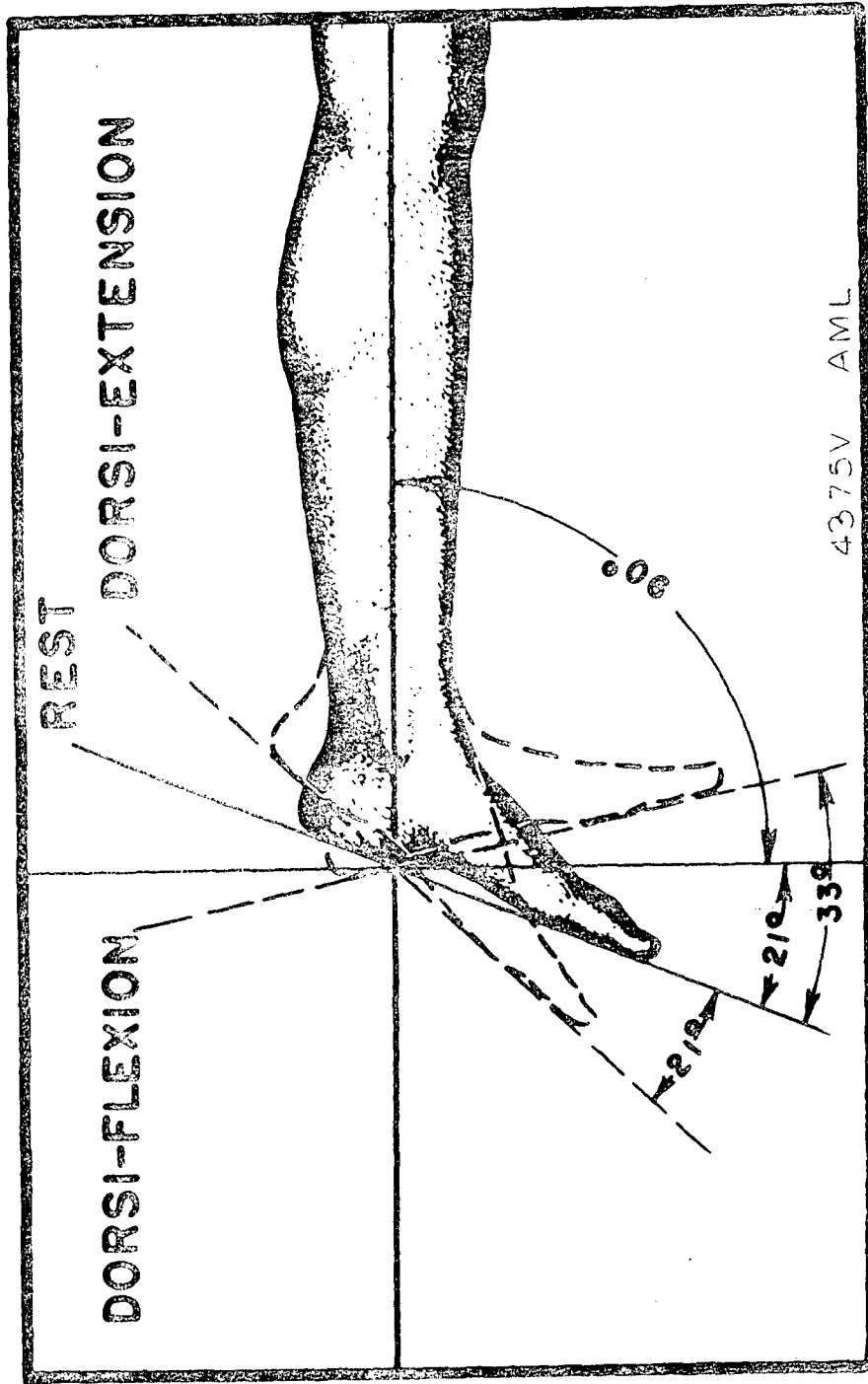

Figure IV, 33.

Finally, there should be some consideration given the technique of approaching the pilot's "bed". The legs may very well be held in the plane parallel to the line of flight, but the thorax, of the trunk, should be lifted about 10° , Figure IV, 37, and a greater degree of comfort will be attained for the head and neck if a comparatively sharp rise, which is adjustable, is provided in the upper chest region. In addition, the bed should be sufficiently cushioned and contoured so as to prevent body contact with resistant surfaces in the areas of the clavicle, the anterior superior iliac spine, and the patellae. There should also be some provision for some lower leg support when the foot is lifted high enough to gain free motion on the pedals. The toes should be installed in stirrups on the pedals.

The problem related to holding the head in a relatively fixed position for some period of time, which probably should not exceed two hours, is much more complicated. In the first place, every effort should be made to prevent contact between the head support and the bearded portion of the face, because this soon results in considerable irritation to the skin. From a purely physical standpoint, the support should not be dependent in any degree upon a chin rest. This is due to the fact that the head itself, acting free on the neck joints, will weigh approximately 15 pounds, and this weight, multiplied by the "g" forces which can be tolerated in this position would result in as high as 180 pounds of head weight resting upon the chin. If the pilot were unfortunate enough not to have a good "bite" with his teeth at the time of the onset of accelerative forces, it is probable that he could break off the condyles of the mandible.

The harness must be designed in such a manner that the weight of the head regularly and under "g" forces will be supported over a broad surface of the forehead. This has been found to be quite satisfactory under experimental conditions. Another factor of great importance is the ability of the pilot to be able to move his head, to be able to utilize as much visual field as possible, and techniques have been developed which will actually permit greater head motion in this position under forces as high as 12 "g" than can be obtained in the usual position under forces not exceeding 4 "g". This obtained by the simple introduction into the system of the head harness of a counter weight and cable system which will permit the head to remain free under any "g" forces applied. The great problem here is to force the head down under very high forces in order to prevent blackout of the pilot.

It has also been found that considerable force can be exerted on the individual control motions, indicating that there is no undue disadvantage in this position so far as control loads are concerned. Subsequent testing has indicated that these forces can be applied throughout the acceleration ranges which can be tolerated by man.

BOMBARDIER-NAVIGATOR SEATING

With the growing interest in high-speed, jet-propelled, bombardment aircraft, incorporating relatively small crews of three men, the bombardier-navigator position has become increasingly important. This crew member will be occupied the entire flight time and all the arrangements for his activities should be designed to provide him with the greatest possible efficiency.

In order to maintain a logical perspective concerning the required arrangements, it should be remembered that the time of the individual will be apportioned as to give not more than ten per cent. of the time to use of the bombing mechanisms. The remainder will be spent on navigation. However, since the main objective of the mission must be accomplished by the actual bombing, it is almost as important to provide efficient arrangement for use of periscopes, etc., as it is to provide such for navigating. Finally, a single seating arrangement must be provided since all the duties are accomplished by a single man. This latter helps in many respects because it benefits the spatial requirements.

Inasmuch as the nose sections of the types of aircraft under discussion are quite small, every effort must be made to reduce the size of the equipment required to be close to the man to the smallest size possible.

Under experimental mock-up conditions it was found that a radar set which had 6.3 cu. ft. could not possibly be broken down sufficiently to be placed in conjunction with the operator. However, another set, which had only 1.1 cu. ft., very easily adapted itself to the limited space requirements.

Two alternate positions of the man may be used. The first, a directly fore-and-aft placement of the chair, with a 90° swivel for the navigating position, and the second, a diagonal position of the chair, with a swivel needed only for emergency clearance of the man to the escape hatch. In the second alternate position, the man is placed in a normal working position at the navigating table, and uses the periscope and radarscope by looking diagonally over the left shoulder. This position is much the easier to use so long as a minimum of manual controls is placed on the 'scopes.

The radarscope may be permitted to swivel to either side of the periscope and will be equally practical. It should be placed about 39" from the floor level.

The chair should be made to provide for use of the back-type parachute and might have armrests to improve comfort, although the navigating table will provide considerable support.

Attention should be paid to placing switches and other manual controls so that they move in a direction corresponding with that of the hand and wrist.

ANTHROPOMETRY IN THE DESIGN OF AIRCRAFT GUN-TURRETS

General Background

Introduction:

The problem of fitting gunners into aircraft gun-turrets was the major stimulus to the inception of the entire AAF anthropometric project. The turret investigation has determined the selection of subjects and measurements in the initial body size survey and has embodied the first application of the data collected in that survey. It has required continuous study from the receipt of the first British turrets at Wright Field in 1940 to the present time (September, 1945), with the existence of several current problems indicating strongly that advice on gunners' accommodations will be required as long as research in aircraft armament is conducted.

The gravity and persistence of the gunner's problem are readily understood when the origin and function of gun-turrets are examined. Aircraft armament is divided into two classes, fixed and flexible guns. Fixed guns, used chiefly for offensive purposes, are aimed by aiming the entire airplane, as in fighter planes or in those "attack" planes (combined fighter-bombers) which have forward-firing guns. They involve no problem of human accommodation, although the body of the airplane in which they are installed may, and are thus of no present concern. Flexible guns, on the other hand, chiefly defensive armament in bombers, are aimed in various directions from inside the airplane. They include hand-held guns, locally-controlled gun-turrets, and remotely controlled guns and turrets. Hand-held guns, which appeared first, are no longer contemplated for installation in new airplanes, according to the 9th Edition of the Handbook. They may be placed anywhere in the airplane, nose, waist, and tail positions being the most common. They do present problems in accommodating gunners, but for the most part the difficulties involve human dimensions only remotely if at all, and have never been as acute as those of local-control turrets. For these reasons, gunners' provisions in crew stations involving hand-held guns have not been extensively studied. Two cases will illustrate the types of difficulty encountered. (1) In the early B-17, the left and right waist windows were opposite one another (Fig. IV, 40), causing interference between the two gunners in scanning for enemy planes, and in operating the guns. In later models, the interference was eliminated by "staggering" the windows (Fig. IV, 41). (2) In the B-24 the windows were not staggered, although the gun mounts were (Fig. IV, 42). In the later phases of the War, only one waist gunner was used since fighter opposition was markedly decreased. His chief complaint, judging from U.R.'s and questionnaires, was the lack of a comfortable seat for scanning on both sides of the airplane.

Local-control turrets and sighting stations then, the latter operating remote armament, are most critical for the gunner. As a result of the earlier development of local-control turrets, much the greater proportion of anthropometric analysis of turrets during the War has been in that direction. To anticipate somewhat, one of the principles derived from the study of turrets is that any apparatus for human use must provide for the man in its design. The

199342

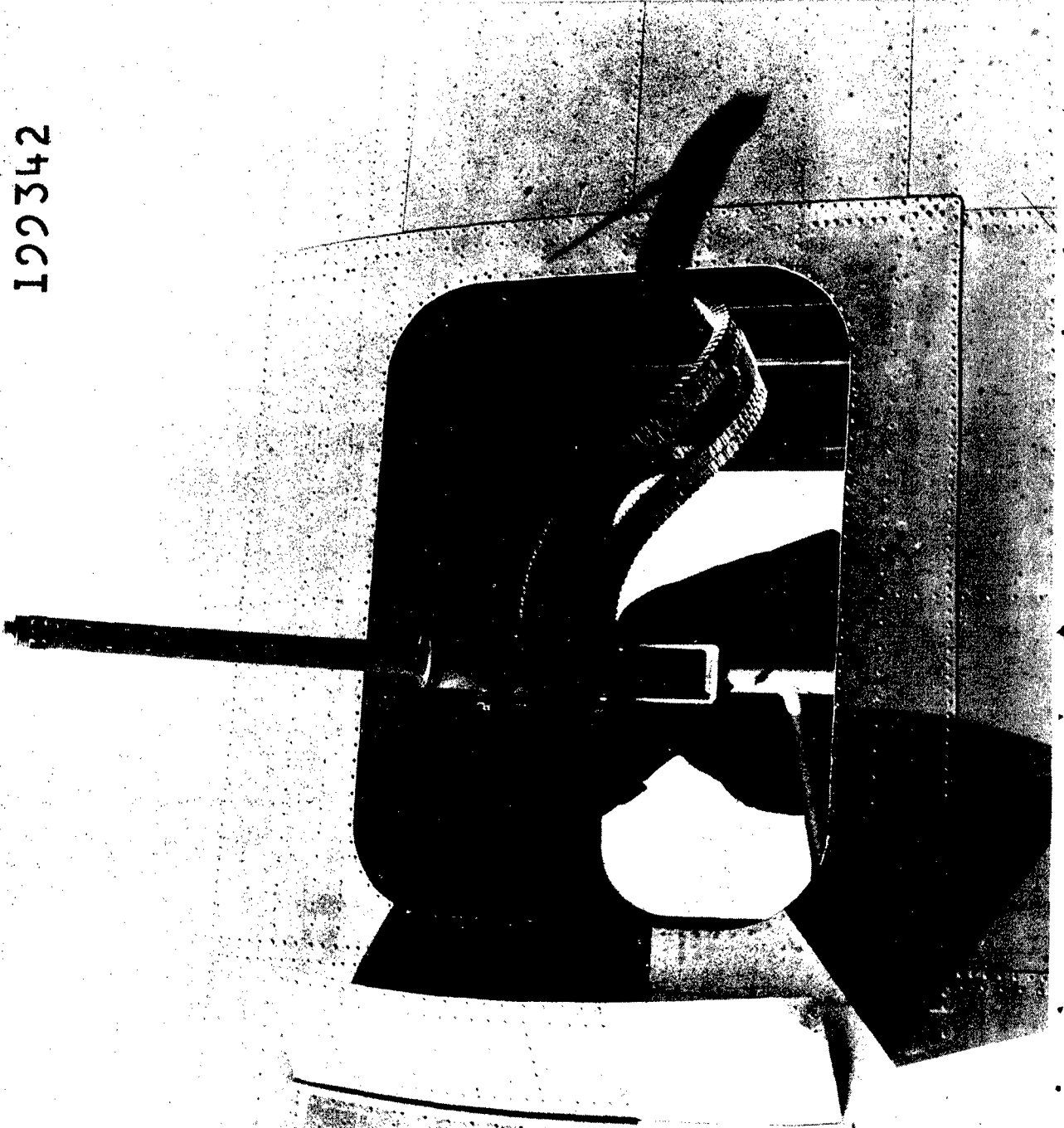

Figure 17, 10

129343

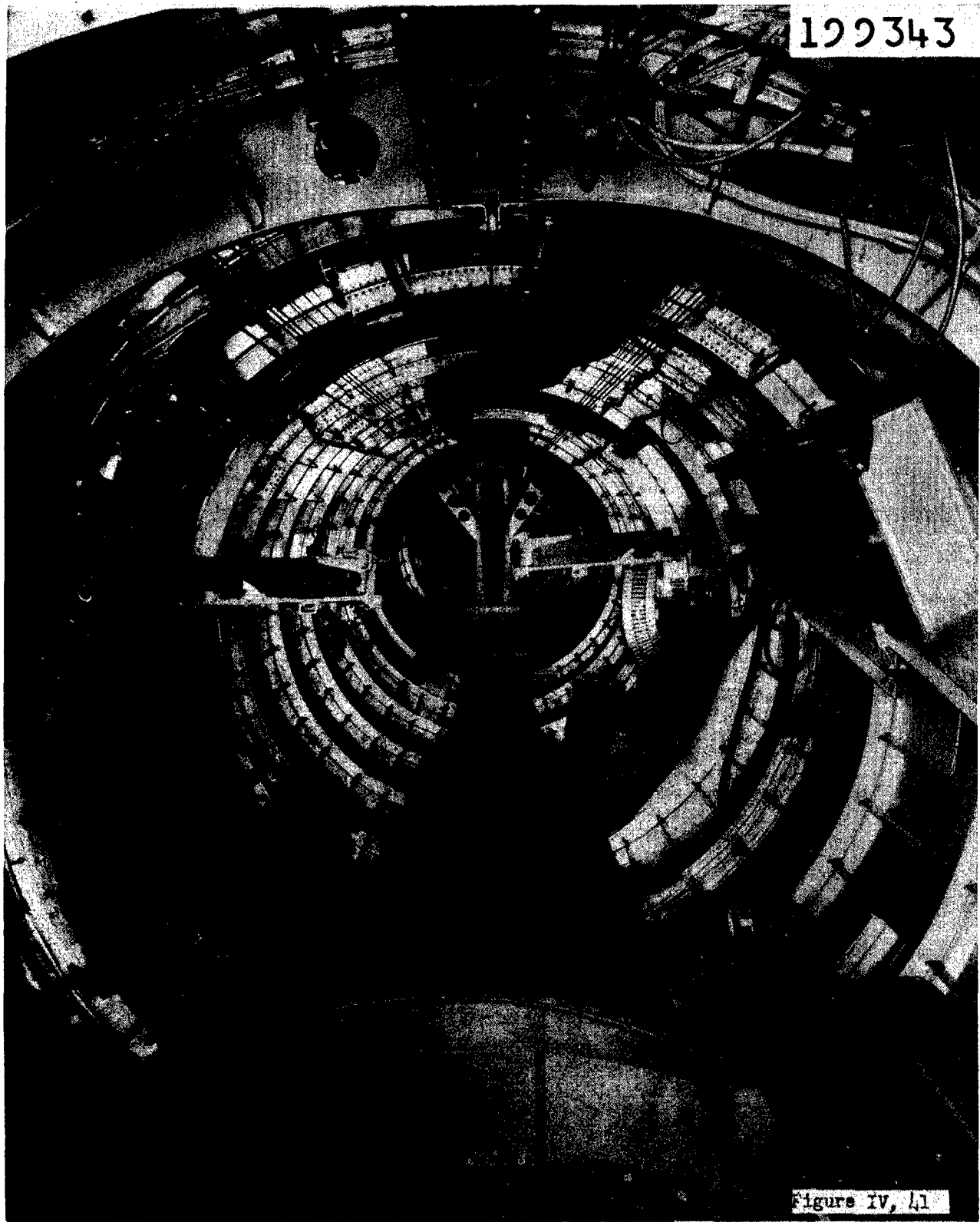
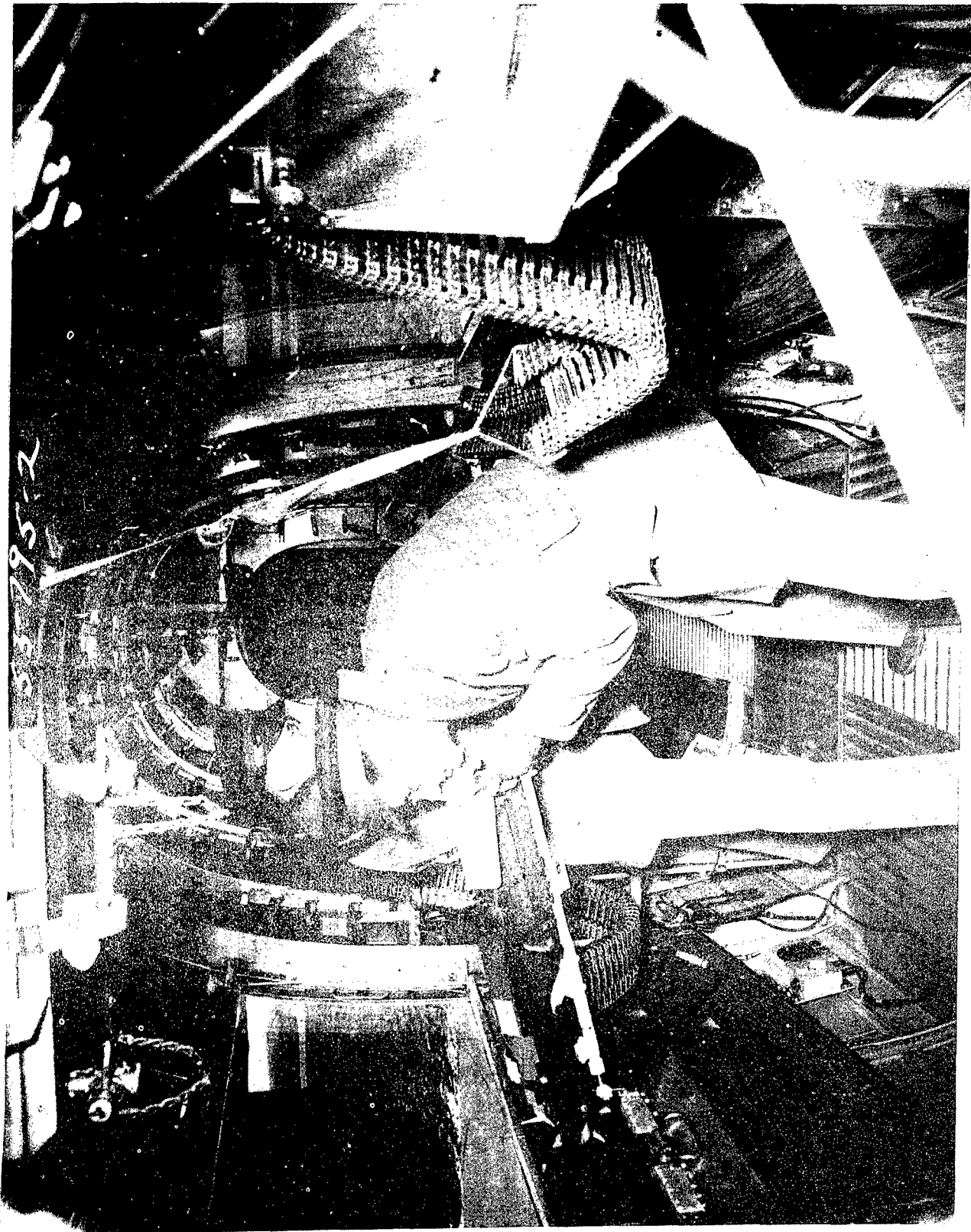

Figure IV, 41



gunner using remotely controlled armament should not, in theory, be cramped for space, since he is in effect sitting in the airplane itself and not in a separate protuberance. Nevertheless, neglect of the principle just mentioned has led to anthropological difficulties which will be considered later in the present discussion.

Definition:

Turrets are defined as "those self-contained power operated gun positions wherein the gunner sitting within the structure controls the position of the guns by manipulating the control handles while tracking the target with the aid of a computing sight. In all locally controlled turrets, the gunner is sheltered within the turret and moves with the guns in azimuth only or azimuth and elevation together." (Handbook, 9th Edition, Ch. 21) Power turrets evolved from hand-held guns through the intermediate stage of a hand-operated turret. The British were the first to produce and use operationally on a large scale turrets which were complete units, containing electrically or hydraulically operated guns, a computing gunsight, and a gunner plus his personal equipment. The effectiveness of such armament is obvious compared to that of hand-held guns or turrets which the gunner had to push around against the airstream while peering through a simple ring-and-bead sight. As seen even at the end of the first World War, the increasing speed of aircraft involved wind forces that the gunner could not handle with reliability and which therefore required power operation.

Turret Evolution:

But the advantages conferred by power operation and computing gunsights, such as completely controllable tracking rates and automatic calculation of the many factors required to hit a rapidly moving target from a moving gun platform, are accompanied by inconvenience to the gunner. Heavy guns and supporting structure, gunsight, ammunition, and sources of power, all occupy space and weight, not to mention the gunner and his personal equipment. Space and weight are always at a premium in aircraft. The basic difficulty has been that, until the latest stages of the War, turrets were an unwelcome afterthought to airplane designers. The primary function of an airplane was conceived to be flight, and the realization came only after costly experience that, in the words of the Handbook, "The efficiency with which a military aircraft can carry out its mission is dependent to a large degree upon the character of the armament installation. . . . Where the armament requirements have been subordinated at the time of initial design, it has been impossible to make satisfactory provisions later."

With space rigidly limited by the dimensions of the plane to which the turrets were added, and with his equipment increasing in bulk and complexity, the gunner himself was an unwelcome afterthought to turret designers, and one of the purposes of the present discussion is to outline the steps by which his importance has become recognized.

When early British turrets were brought to Wright Field for examination, most of the American engineers who tried them found them too small for their comfortable and efficient operation. This might have led anthropologists to

speculate on possible size differences between British and American aircrew (some differences have been found, chiefly that AAF aircrew are broader and heavier), were it not for the fact that later British turrets afforded gunners' accommodations superior to those of early American models. As in other aspects of aircraft and turret development, each new designer has had to learn for himself. Not only did the RAF learn the lesson of the gunner's importance earlier in point of time than the AAF, since the British turret development began sooner, but extraneous circumstances combined to maintain this advantage. The use of .30 caliber machine guns requires much less supporting structure than the heavier, farther-ranging, and more destructive .50 calibers; and the British employment of heavy bombers on short-range, low-altitude, night missions meant that aerodynamic cleanness and weight considerations could be compromised in the gunner's favor. The AAF's tactics enjoined the opposite policy.

Body Size Survey:

The danger that the severe limitation imposed by early turrets on gunners' efficient operation would restrict the size and hence the number of potential gunners was apparent to Col. Benson as early as 1940. In Feb. 1941 he invited Dr. Hooton, Head of the Anthropology Department at Harvard University to Wright Field to examine British and American turret models, to give a preliminary evaluation of their suitability, and to draw up a list of body measurements important in turret design. Dr. Hooton climbed into the various turrets, observing those dimensions which seemed to be critical for fit or important in view of the gunner's position and required movements. His findings emphasized the advisability of a general survey of AAF flyers, both cadets (who become pilots, co-pilots, bombardiers, and navigators) and gunners, who would occupy the turrets and most other gun positions. Not only were those body measurements necessary which were applicable to the particular turrets observed, but standard anthropometric measurements were desirable to cope with future turret designs. In addition, such measurements have in fact, been found to afford reasonable predictions of those special dimensions subsequently required. And since the value of the body size survey would be enhanced by its applicability to aviation materiel other than turrets, measurements dictated by turret problem plus others chosen for general utility were selected. Only the former are of present concern.

295½ Aviation Cadets and 58½ gunners at two of the three Air Corps reception centers for each category were included in the survey.

The measurements were reduced to percentile values, from 5 through 95, "as the most practical elaboration of statistics" for the purpose. In addition, correlation scattergrams were drawn up between the generally taken measurements of stature, weight, and sitting height and those of importance in the turret problem (such as buttock-knee length, knee height, buttock breadth, anterior arm reach, shoulder breadth, abdominal depth, breadth across knees and elbows), and among various pairs of the special turret dimensions. The description of the measurements, percentile distribution of each, and the useful correlation tables are presented in Appendix 3.

The Problem

Armed with percentile distributions and correlation tables of body dimensions of AAF flyers, the anthropologist can attack the turret problem directly. By the time the body size survey had been completed and the data reduced in September 1942, there were several standard turrets in production and in service, despite acknowledged shortcomings, since considerations of perfection cannot be allowed to hinder production of a vital item. By position in the plane, there were three uppers (Bendix, Martin, and Sperry); 1 tail (Consolidated); and 2 lowers (Bendix indirect, Sperry-Briggs ball). Subsequently, the Bendix lower was discarded, and two alternate tail turrets for the B-24, the Emerson (also used in the nose position) and Motor Products, became standard.

Turrets generally place the gunner in one of three postures: standing, as in the Sperry upper turret (in B-17 airplane); more or less on his sacrum, with legs bent, as in ball turrets (in B-17, later in B-24 and B-32 airplanes); and sitting, as in all others. This variety of types, the result of different requirements of turret weight, size, and shape imposed by different airplanes, is likewise reflected in the diversity of internal arrangements affecting the gunner and consequently the anthropologist. The gunsight may move or remain fixed as the gunner tracks an enemy plane through it; his legs or his head, or both, may be cramped, or neither of these, but his elbows; he may or may not be able to wear a parachute or body armor; his seat may or may not be adjustable to bring his eye to the gunsight level.

The problem common to all turrets, however, is four-fold: (1) to evaluate existing turrets in terms of percentages of AAF flyers accommodated and the quality of accommodation afforded. If all AAF flyers are not accommodated, (2) to establish size limits for selecting gunners for training. It seems obvious that a flyer should not be given an intensive preparation, only to find that he cannot fit into the turret for which he has been trained; but it has occurred. (3) To ascertain the nature and cause of any difficulties encountered, and to attempt to remedy them. The chief focus of interest will inevitably be installations within the turret which may be modified without materially slowing production, since major redesign may hardly be feasible in view of the pressure for production, and, to a lesser extent, the fixed dimensions and design imposed by the airplane housing the turret. After the first three problems have been met, the experience gained should be used in a fourth direction, which is (4) to set up criteria for new designs.

Procedure

The problem has now been presented, as well as the tools for its solution. The next step is to outline the procedure followed. It appears simple to measure a turret, locate the measurements in the percentile distributions of flyers' body measurements, and thereby estimate the percentage of flyers accommodated by the turret. In fact, it was thought at first that the distribution tables could be shown to turret designers, the technical words explained, and that the anthropologists' task would be thereby accomplished. However, it soon became apparent that the applied anthropologist has only begun when he has measured his subjects and completed his statistical analysis. One of the most consistent experiences of the entire AAF project has been that anthropometric data will not be applied correctly - not that they cannot - except by or under the direction of anthropologists.

Clothing Increments:

In the first place, nude subjects had been measured, whereas bombardment airmen wear some 117 pounds of combat equipment. This made it necessary to determine the increments added by various combinations of clothing and personal equipment. The two typical clothing outfits worn at the time were heavy winter shearling (Fig. IV, 43) and the earliest electrically heated suit, Type F-1 (Fig. IV, 44). The shearling was considerably bulkier. As subsequent outfits, such as the F-2 electric suit (Fig. IV, 45) were developed, their increments were added, until the following table was completed (Fig. IV, 46).

Determination of Critical Turret Dimensions:

An even more serious consideration than clothing bulk in preventing immediate application of the flyers' body size percentiles to turrets is that mere measurement of turret dimensions is insufficient. Not only are movements even more likely to hamper efficiency than cramped quarters alone, but the selection of significant turret dimensions is imperative. An almost infinite number of turret dimensions could be measured, only a few of which might be critical. In fact, turret investigations by the Aero Medical Laboratory antecedating anthropometric analysis did include many irrelevant measurements which appeared logical to take but which proved useless. The only way to ascertain the critical points is to have men simulate the gunner's actions in each turret.

Selection of Subjects:

Accordingly, several officers and enlisted men, measured according to the original body size survey blank, are selected to typify the range of body size in Army flyers - of all flyers, it should be noted, not gunners alone, since combat experience has demonstrated the need for interchangeability of all crew positions. In an emergency, any crew member may have to fill another's position. Dimensions of a typical group actually used in early turret analyses are given in Figure IV, 47. These half-dozen subjects are dressed in standard flying gear, and their difficulties in operating each turret are noted. When any troubles, either of static fit or of required movements, are due to their

122341

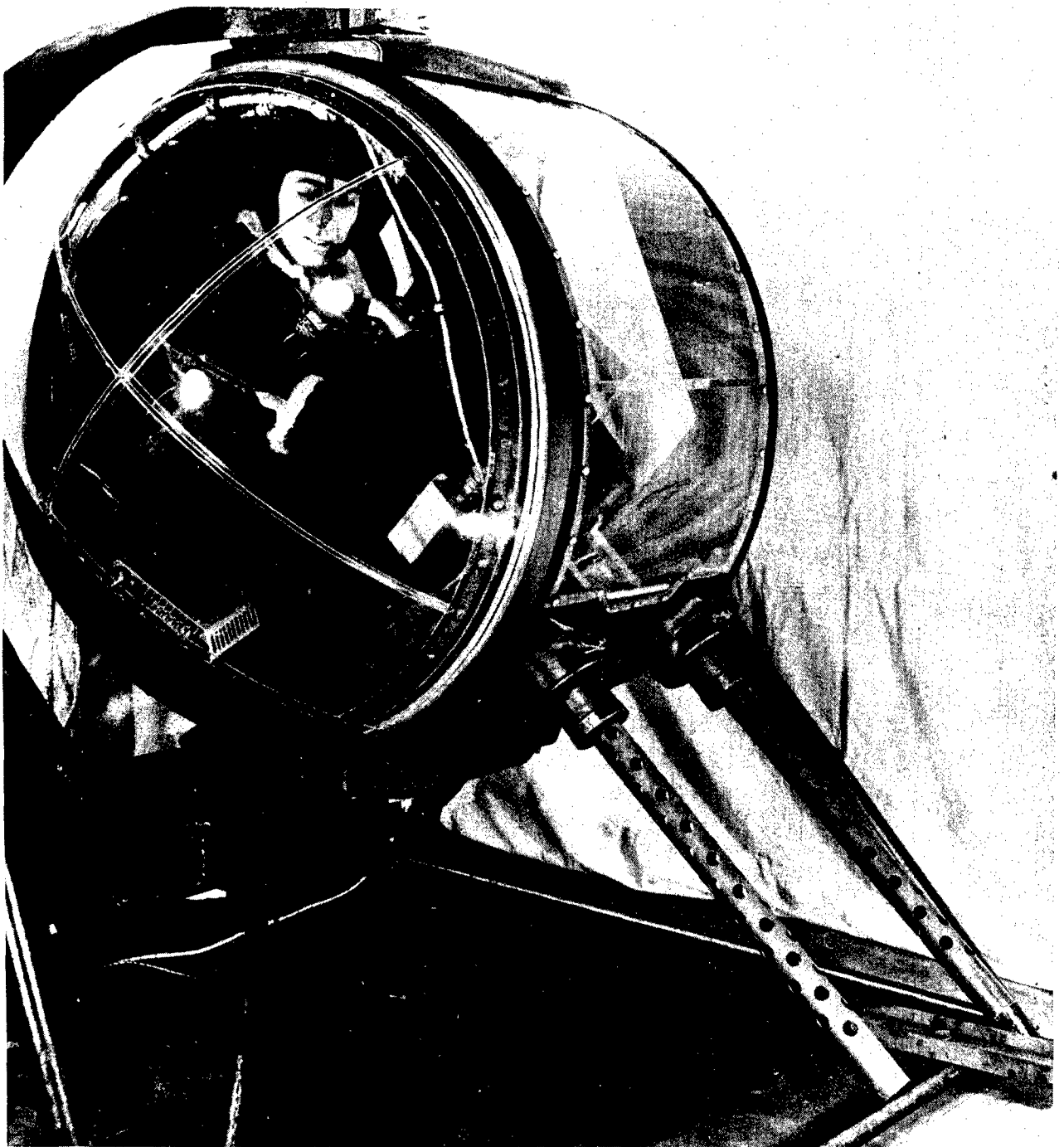
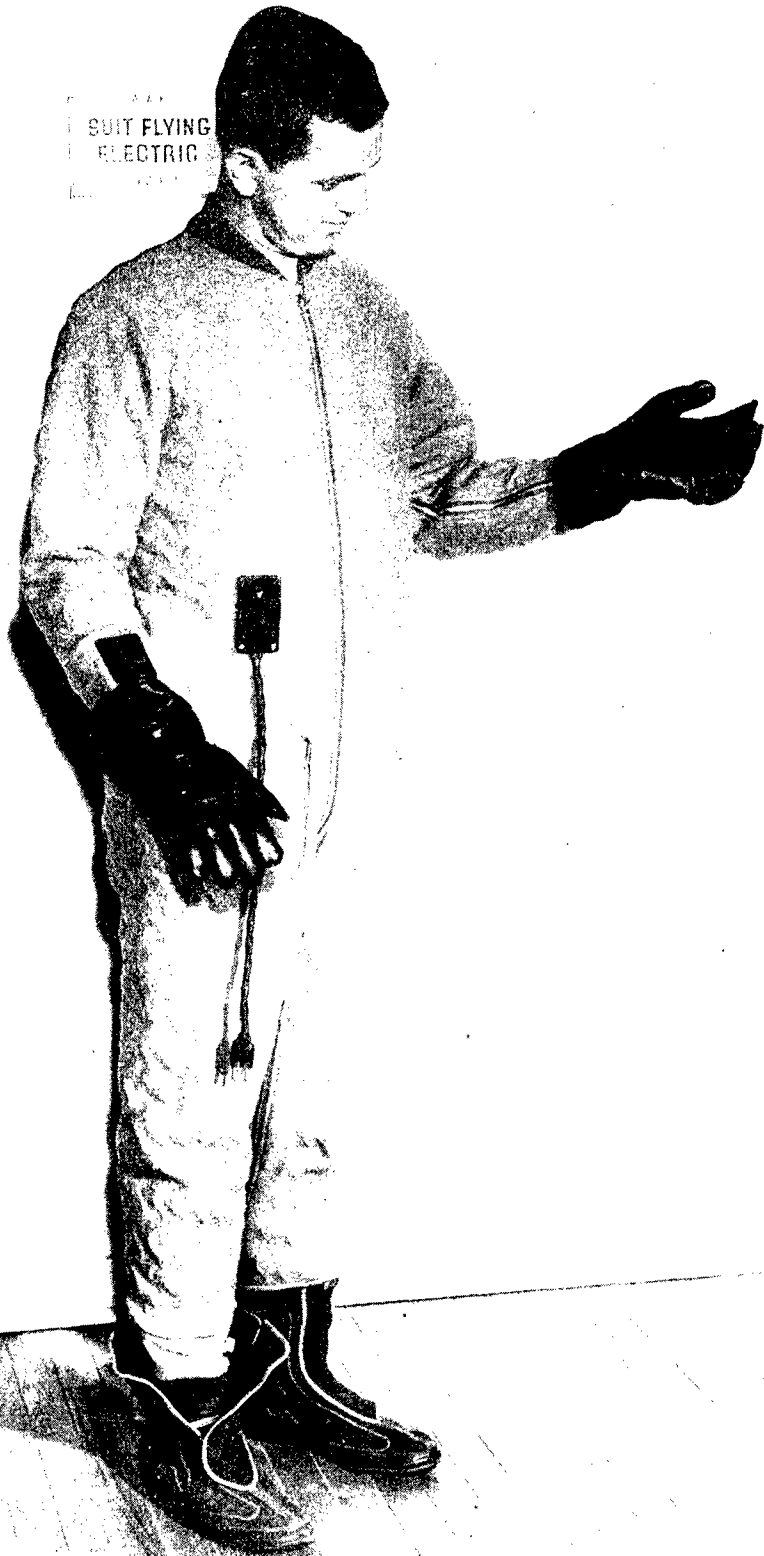

Figure IV, 12

SUIT FLYING
ELECTRIC

S



746

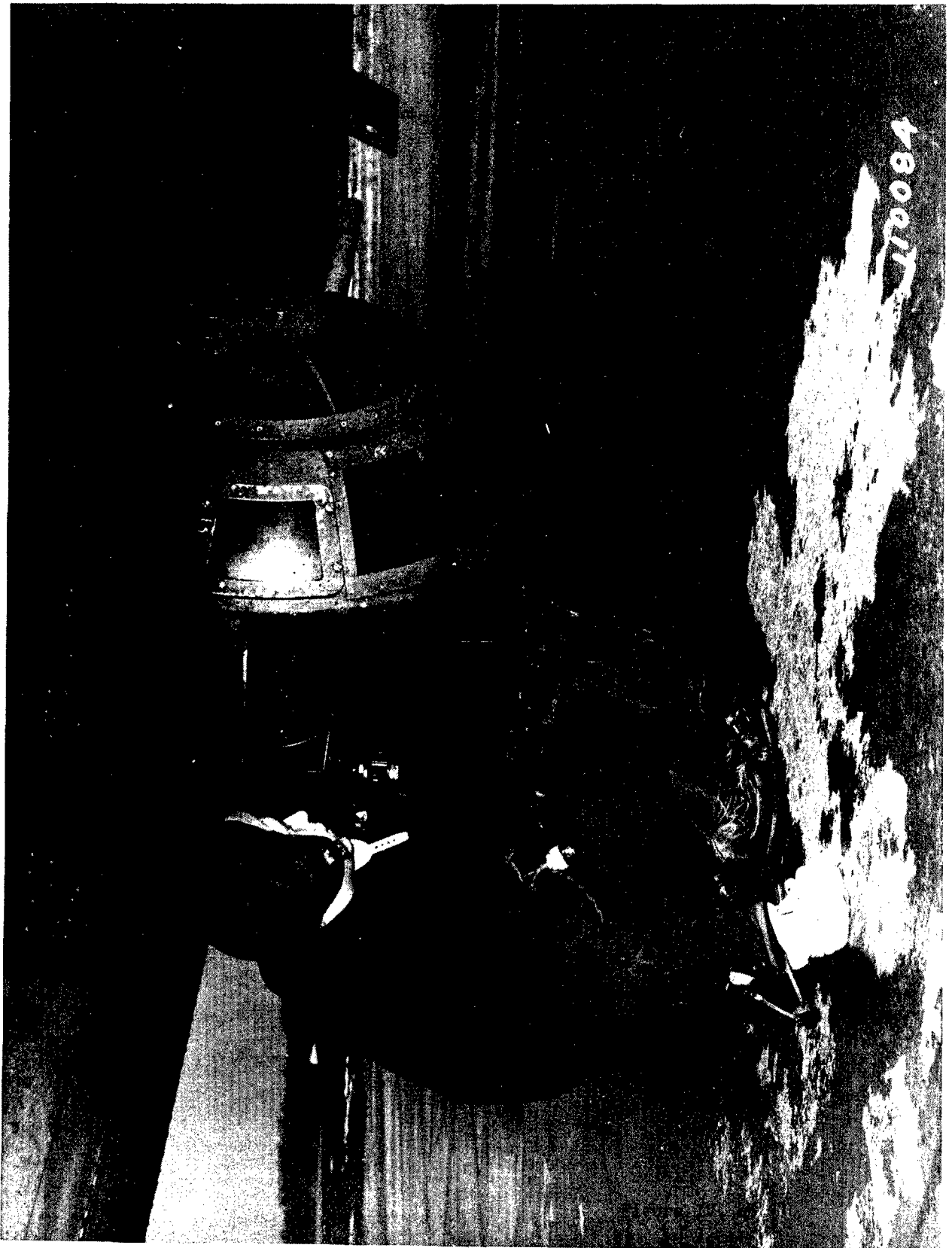

117

110084

AMOUNTS ADDED TO NUDE DIMENSIONS BY TYPICAL CLOTHING OUTFITS

	1 Heavy Winter Flying Clothing	2 Electrically Heated Suit (Old Type)	3 Quilted Suit	4 Electrically Heated Suit (New Type)	Pounds	Inches
Weight.....	20.0	16.0	14.0	15.5		
Stature.....	1.9	1.8	1.9	1.2		
Trunk Height.....	.6	.5	.7	.5		"
Sitting Height.....	.6	.6	.6	.6		"
Head Height.....	.2	.2	.2	.2		"
Sitting Height Minus Head Height.....	.4	.4	.4	.4		"
Buttock-Knee.....	.5	.4	1.1	.3		"
Patella Height.....	1.8	1.6	2.2	1.9		"
Total Span.....	.4	.2	0.0	0.0		"
Span Akimbo.....	.8	.4	0.0	0.0		"
Anterior Arm Reach.....	.4	.2	0.0	0.0		"
Shoulder-Elbow Height...	.3	.5	.3	.5		"
Biacromial.....	1.3	.4	.8	.2		"
Bideltoid.....	.7	.5	.8	.2		"
Chest Breadth.....	.6	.4	.6	.5		"
Elbow Breadth.....	4.4	2.4	4.7	2.9		"
Chest Depth.....	1.4	.7	1.7	.7		"
Abdominal Depth.....	1.4	.4	2.2	.8		"
Bi-iliac.....	1.3	.4	2.1	.8		"
Bitrochanteric.....	1.7	.5	2.5	.6		"
Knee Breadth.....	2.5	2.5	2.1	1.0		"
Squatting Diagonal.....	2.9	1.0		"
Hand Length.....	.3	.4	.4	.2		"
Hand Breadth.....	.4	.2	.3	.2		"
Foot Length ⁵	2.7	2.7	2.7	2.7		"
Foot Breadth ⁵	1.2	.7	.9	.9		"
Calf Circumference.....	6.0	1.6	3.9	1.8		"
Chest Circumference.....	9.1	4.4	6.8	3.4		"
Head Length.....	.4	.4	.4	.4		"
Head Breadth.....	.4	.4	.4	.4		"
Head Circumference.....	1.7	1.7	1.7	1.7		"

1 B-3 jacket, A-3 trousers, B-5 helmet, A-9 gloves, A-6 boots

2 F-1 suit, B-5 helmet, A-6 gloves, A-9 boots

3 SJ-4* jacket, ST-9*trousers, B-6 helmet, A-9 gloves, A-6 boots

4 PA-17-LI*jacket, PA-17-MI*trousers, B-6 Helmet, PA-17-DI* gloves, A-6 boot,
A-4 coverall

5 Measurements; A-6 boot, medium; 12.8" long, 5.0" wide: A-6, large; 13.5" long,
5.3" wide: A-9, large; 13.2" long, 4.7" wide.

*Manufacturers' numbers; Thomas Quilt Factories, Denver; General Electric
Co., Bridgeport, Conn.

Nude Dimensions of Turret Subjects**

	Height Mile * C O	Weight Mile C O	Sitting Mile Height C O	Trunk Mile Height C O	Shoulder Mile Breadth C O	Elbow Mile Breadth C O	Knee Mile Breadth C O	Buttock- Mile Knee C O	Knee Mile Height C O
Allen	72.0(68-97)	183(94-96)	37.4(77-91)	24.4(75-88)	18.2(60-75)	17.2(70-75)	8.3(93-96)	25.3(94-97)	23.4(93-96)
Benton	69.3(51-71)	135(12-24)	34.7(8-19)	23.1(25-43)	17.5(25-40)	16.8(55-65)	7.3(15-25)	24.6(84-94)	21.8(45-65)
Damon	69.2(50-70)	148(40-53)	36.2(43-60)	24.0(60-80)	17.9(45-60)	16.7(50-63)	7.9(65-80)	23.7(55-70)	21.5(30-50)
Pett	65.7(8-20)	133(10-20)	35.9(33-50)	24.2(68-85)	16.4(3-4)	15.3(9-15)	7.3(15-25)	22.1(6-18)	19.8(3-5)
Sadlowski	70.0(63-81)	183(94-96)	38.9(99-99)	25.1(93-97)	18.7(80-90)	17.2(70-75)	7.9(65-80)	23.6(50-68)	21.3(25-43)
Staup	69.4(54-74)	186(96-97)	37.5(80-93)	24.8(85-95)	18.3(65-80)	17.5(78-85)	8.2(88-95)	23.6(50-68)	21.7(40-60)
Vargo	67.8(29-49)	184(95-96)	36.5(53-70)	22.9(18-35)	19.3(95-98)	18.5(96-97)	8.9(97-100)	23.2(35-33)	21.5(30-50)
Wernet	63.6(3-6)	141(24-35)	(±3)	(±3)	(±10)	—	—	(±5)	(±2)

* In inches; weight in pounds.

** Cadets and Gunners.

4533P-A M L

Figure 3, 17

physical dimensions, the turret dimension involved is measured; and from the percentiles in the flyers' series between which the turret becomes unsatisfactory to the subjects, there is obtained an approximation to the percentage of flyers who will be accommodated and hence to the upper limit of that human dimension to use in selecting gunners for that turret. Since the Training Command can hardly be expected to take such esoteric measurements of gunners as appear in the Anthropological Survey, the correlation tables are consulted to translate all the special measurements into the routinely taken height and weight. The correlation between height and length dimensions on the one hand, and between weight and breadths and girths on the other is high enough, for AAF flyers, that the height and weight can serve as rule-of-thumb approximations to the others.

Anthropometric Analysis:

Anthropometric analysis, it became apparent from a preliminary inspection of turrets, comprehends four aspects of gunners' accommodations, all closely inter-related, but more conveniently evaluated separately: comfort, efficiency, vision, and safety. A brief discussion of each, with examples occurring in specific turrets, will be presented, followed by an illustration of the entire procedure of anthropometric analysis to (a) the Sperry turret and (b) a comparison of three alternative turrets for the tail position of the B-24 airplane.

(1) Comfort includes the purely metrical and relatively static adaptations of the gunner to his space and to his equipment, as well as general factors like thermal adequacy, ventilation, noise levels, freedom from drafts, and the like. Spatial adjustment, in turn, consists of vertical, lateral, and anterior-posterior (in engineering terms, fore-and-aft) accommodation. The following are typical examples of deficient provisions for the gunner's comfort.

a. Shoulder Breadth in Bendix Upper Turret

The Bendix upper turret (Type A-4, Model N; installed in the B-25 airplane) illustrated in Fig. IV, 48 has as a major structural component a "box casting" of frame in the shape of a sector 20 inches across its greatest breadth (at the azimuth ring, the arc of the sector) and 19 inches across the gunner's shoulders. Shoulder breadth in AAF flyers averages 18 inches, to which shearling clothing adds 0.7 inches and the F-1 electrically heated suit, 0.5 inches. Furthermore, flying clothing of any type pushes the gunner forward to the portion of the box casting narrower than 19 inches. Nude shoulder breadth, it will be recalled, is measured with the elbows held tightly to the sides, whereas the shoulder position involved in operating the Bendix turret control handles adds from 1/2 to 1 inch to shoulder breadth. From such calculations, confirmed by the difficulties experienced by selection subjects, it is estimated that at least 50% of AAF flyers in light flying clothing (that is, a coverall over shirt and trousers) cannot fit the turret at all, or cannot rotate the control handles fully in azimuth. In heavy clothing, virtually 100% are disaccommodated.

X

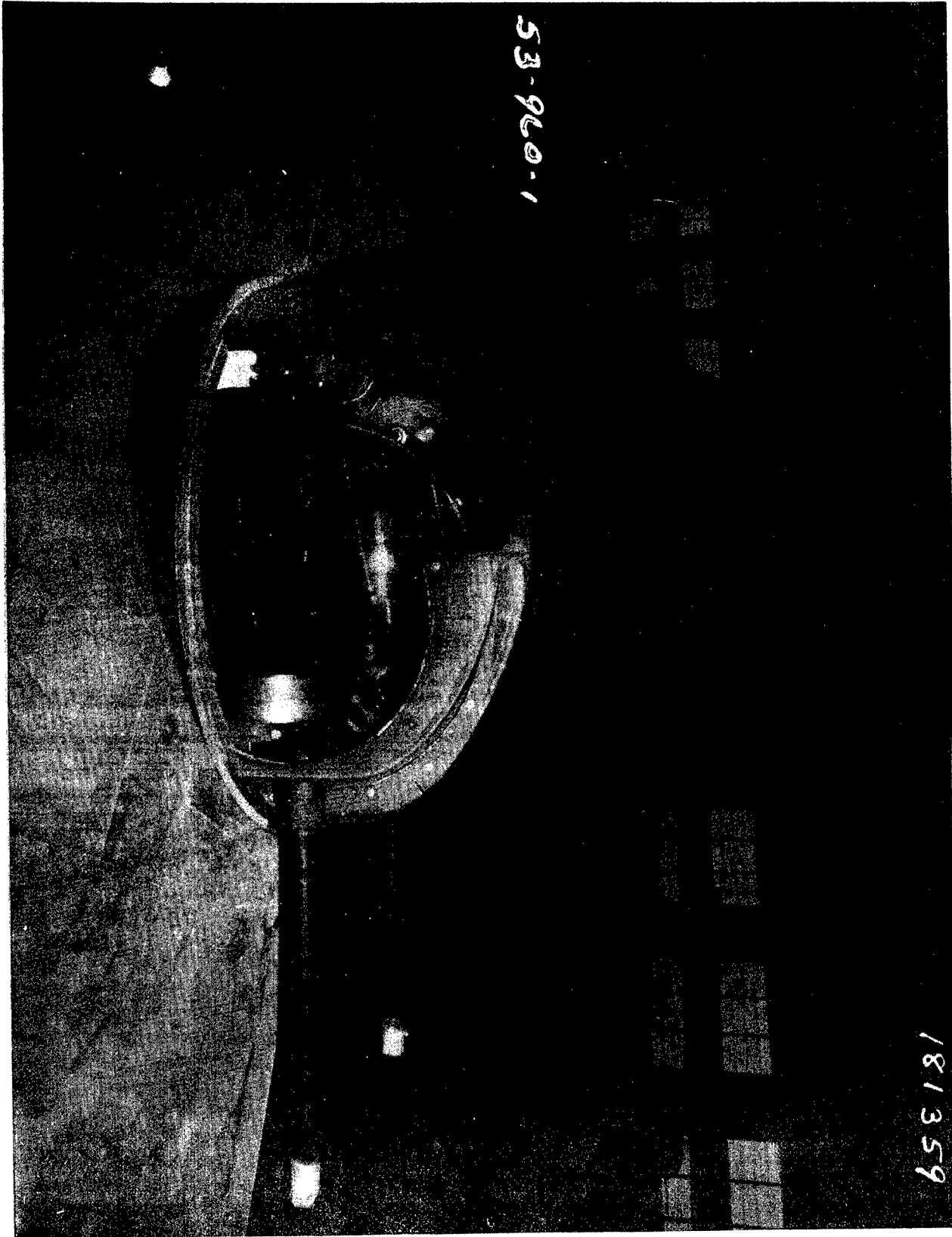

53-960-1

181359

This difficulty has always hampered the Bendix upper. When the anthropometric findings were discussed with Bendix Engineers, the latter acknowledged the deficiency, but stated that no remedy was possible, inasmuch as the turret diameter is determined by the narrow fuselage of the B-25.

b. Knee Height in Consolidated Tail Turret

In the Consolidated tail turret (Fig. IV, 49) for the B-24 airplane, a serious vertical constriction is imposed on the knee by the relatively short distance, 21-1/4 inches, from the foot firing pedals (on which the foot rests), when depressed, to a stiffening frame above. Nude knee height - from floor to top of knee, in sitting position, with lower leg at right angle to thigh - averages 22 inches in cadets and 21.5 in gunners. The floor slopes upward aft of the foot pedal, enabling the knee to be lowered only slightly by advancing the foot. With severe constriction, as felt by individuals with long lower legs, the foot cannot be advanced at all, causing an acute angle at the knee, extremely fatiguing and dangerous because of the likeliness of impeding the circulation of blood. Some constriction was felt even in light clothing by subjects of average knee height. With the addition of 1.8 inches to knee height by the shearling A-6 boot combination (the F-1 electric suit plus A-9 boot adds 1.6 inches), only about 15% of AAF flyers were accommodated and at least 50% seriously discommoded.

Later models of the turret ameliorated the difficulty by having the floor continue aft without sloping, but production of the turret was discontinued before major modifications were introduced.

c. Draft in Ball Turret

In June, 1943, the following report from the 8th Air Force was received by the Aero Medical Lab: "It has been noticed by gunners in this (ball turret) position that the lower part of the outside of the leg is subject to direct blasts of cold air, especially if the turret is turned so the firing is in a lateral direction. Consequently, uncomfortably cold feet is a common experience - It is probable that this is due to the direct current from a space 1/6 to 1/2 an inch wide around the shell ejecting chute. No known reason why this opening could not be closed."

The report was brought to the attention of the Armament Unit, Production Section, and the turret examined in conjunction with a representative of that office. It was decided that the condition could be corrected by attaching a strip of felt between the ejection chute and the opening for the chute in the turret casting. The Briggs Company agreed to incorporate the change in production turrets.

(2) Efficiency implies convenience in operation and includes such considerations as placement and construction of controls, instruments, gunsights, guns

122360

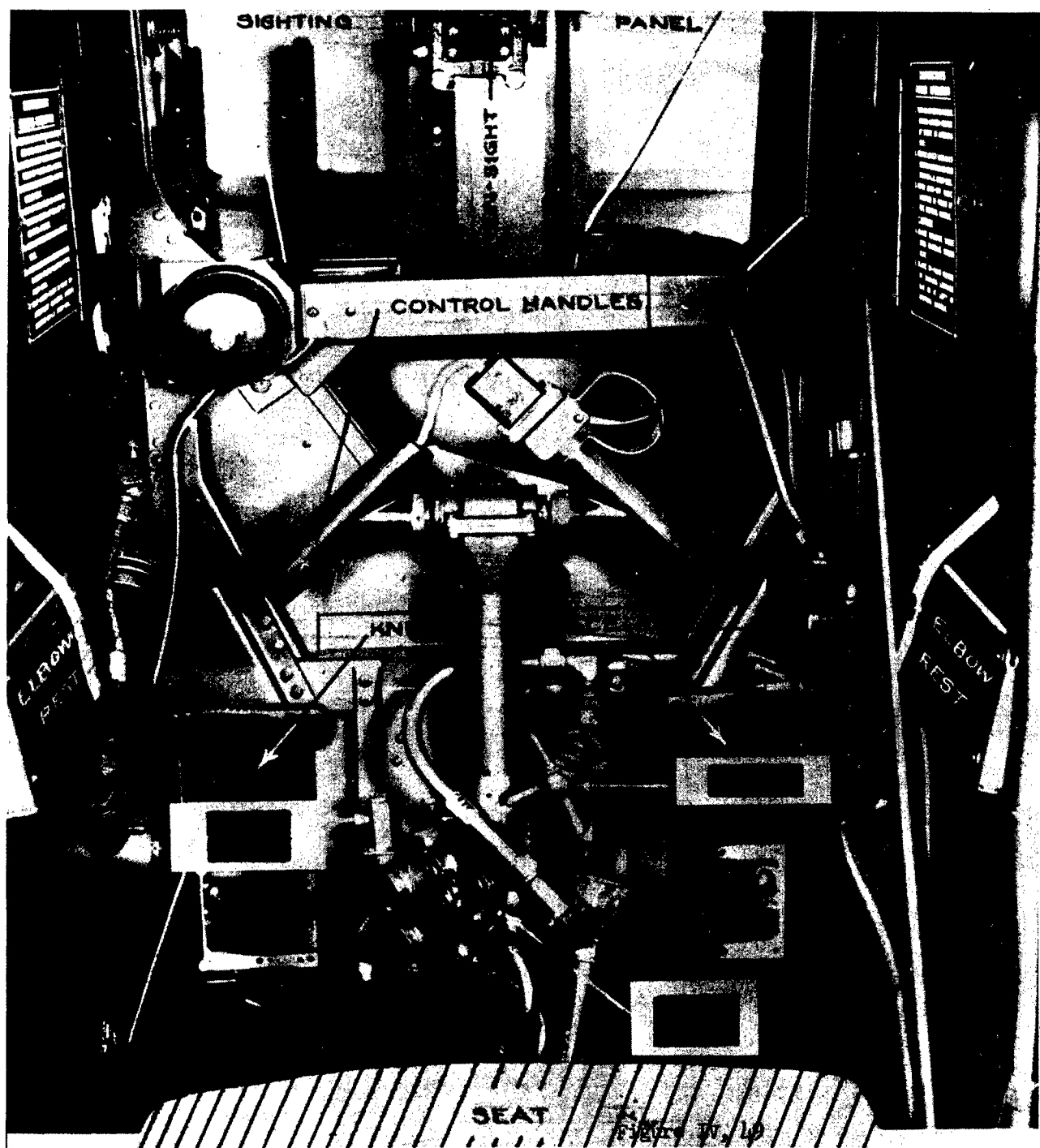

(for in-flight servicing), and other equipment which the gunner must manipulate. Most of the application of the anthropometric percentiles has been in the evaluation of gunners' comfort and efficiency. Fatigue tests, to be described later, were attempted in order to obtain a direct comparison of a gunner's efficiency with various turret arrangements, but the attempt failed because the numerous variables could not be controlled. The following are examples of anthropometric concern with efficiency in turrets:

a. Range Pedal in Ball Turret (Figs. IV, 50 & IV, 51)

In the early models of the Sperry-Briggs ball turret, the range pedal, which feeds data to the computing gunsight on target distance was operated by pushing downward against a strong spring with the left heel. The pedal was located 22 inches forward of the seat back and 4 to 5 inches toward the gunner from the ammunition box in front. In ordinary clothing, neither the shortest subject (buttock-knee length 21.4 inches, 2nd percentile of cadets and 8th of gunners) nor the tallest (buttock-knee length 24.6 inches, 83rd percentile of cadets and 93rd of gunners) could operate the range-finder satisfactorily, whereas intermediate subjects could. A short thigh made the lower leg push at an acute angle instead of straight down, as required by the pedal; with the result that the gunner had insufficient strength and length of leg to utilize the lower third of the pedal's excursion. A long thigh, on the other hand, involved the gunner in obstructions at the knee and toe with the ammunition box.

Inasmuch as the intermediate subjects, who could operate the pedal, ranged from the 35th - 53rd percentiles to the 73rd - 85th (of cadets and gunners, respectively), it could be concluded that roughly the middle third of the AAF flying population was accommodated wearing light clothing and shoes.

However, combat gunners almost always wore heavy winter flying boots, (Type A-6). Wearing both medium and large sizes (and since the A-6 boot is worn over shoes, the larger boots are to be expected), no subject could operate the pedal. Rotating the turret to place the gunner on his back helped only slightly. The two subjects with the longest thighs could not even place their heels in the pedal stirrup. As for those who could, the lower edge of the ammunition case pressing down on the foot depressed the pedal permanently, so that it could be operated only through the upper fourth of its range.

Several remedies for this intolerable condition were attempted. Special felt boots were designed for the gunner; the ammunition boxes were taken outside the turret, then replaced; a toe-operated pedal was devised and tested; but the only real solution came late in the War, with the adoption of a hand-operated range-finder.

b. Gun-Charging Handle in Sperry Upper (Fig. IV, 52)

This handle would not permit passage of a hand wearing standard
154.

808081

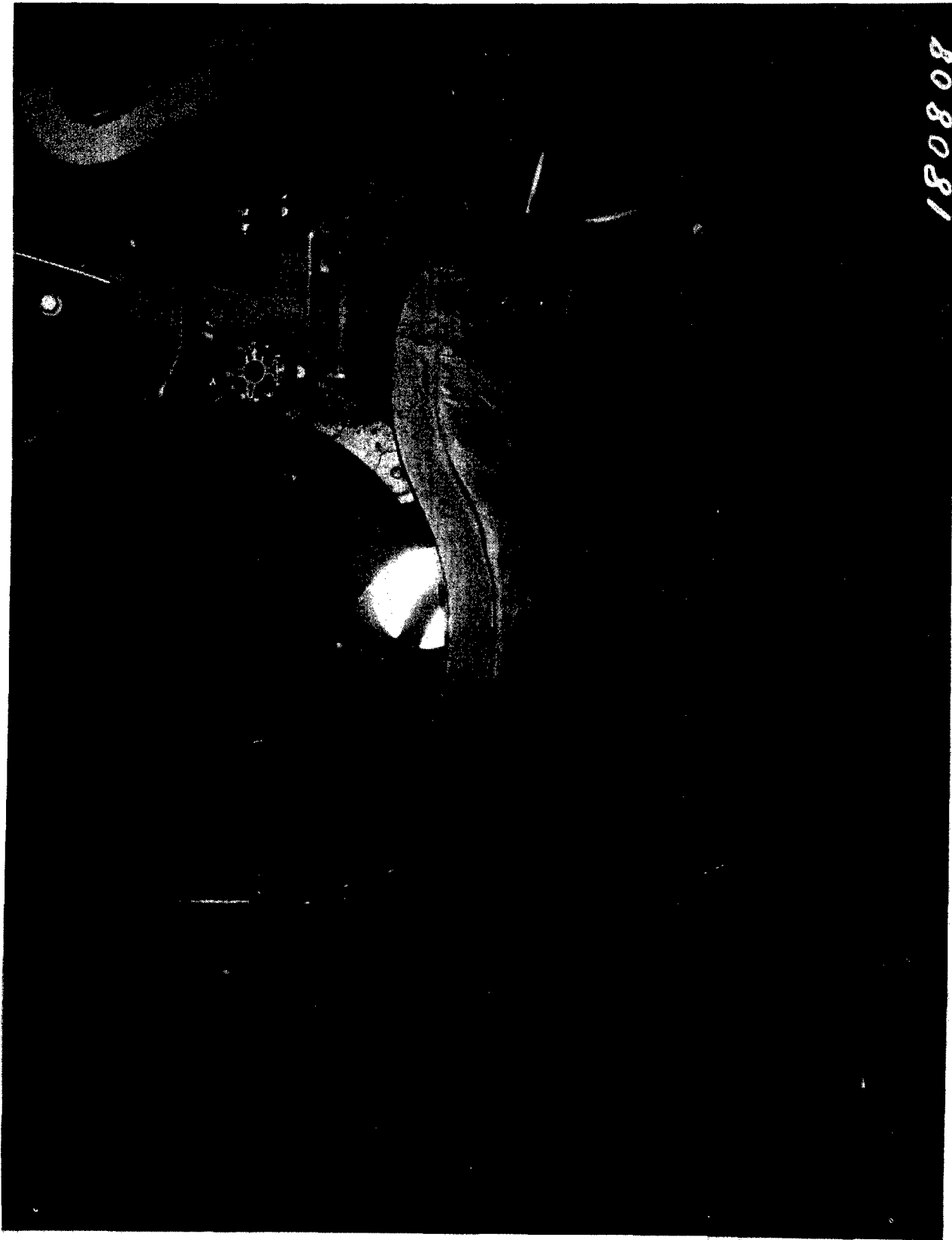

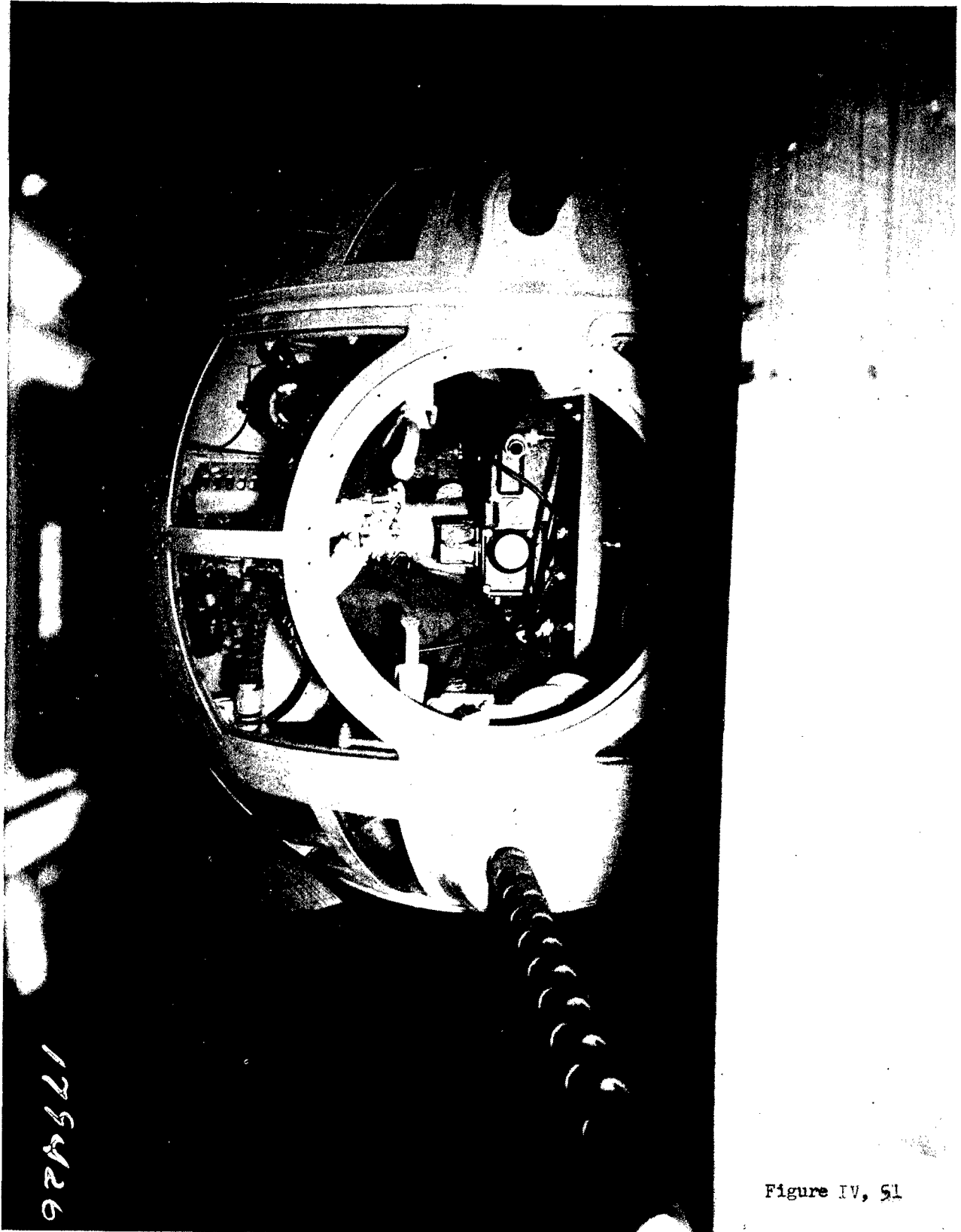

178426

Figure IV, 51

14 2827

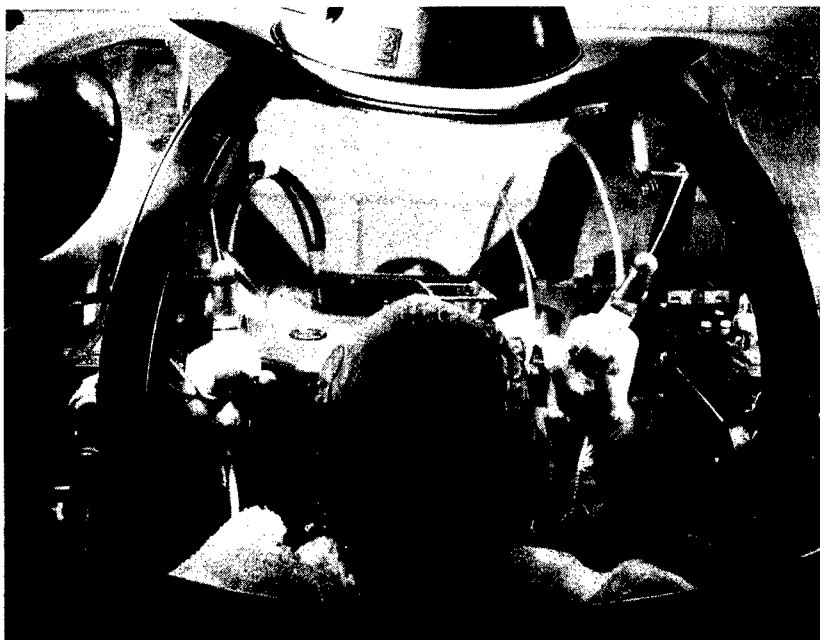

CHARGING GUNS

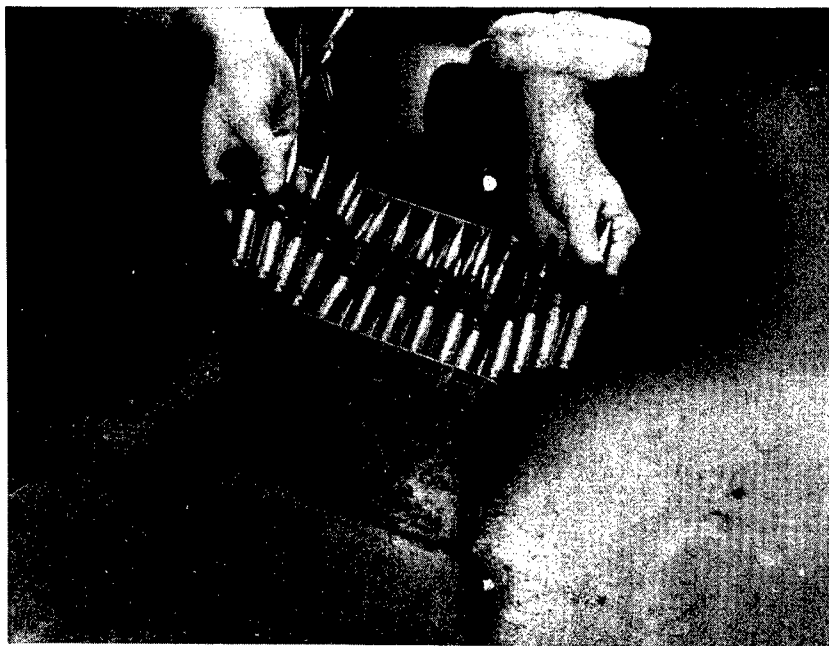

LOADING AMMO. CAN

Figure IV, 52

flying glove, since the manufacturers had not been aware of the gunner's combat equipment. Once the gloves were demonstrated, the narrow handle was replaced first by a larger leather thong and later by a ball and cord.

c. Head and Face Cramping in Sperry Upper (Fig. IV, 52, & IV, 53)

Trials on 8 selected subjects, wearing various clothing assemblies, demonstrated that in any high-altitude clothing (including the electrically heated suit) even without parachute, it was excessively difficult or impossible to wear any type of oxygen mask. The following dimensions show dramatically the inadequacy of the clearance provided:

- (1) Back of turret to sight when horizontal: 12 inches.
- (2) Back of turret to sight at 30° elevation: 6.5 inches.
- (3) Average AAF flyer, back to head to forehead: 8 inches.
- (4) Average AAF flyer, back of head to tip of nose: 9 inches.
- (5) Average AAF flyer, back of head to tip of A-10 oxygen mask: 11.5 inches.
- (6) Clearances established by Aero Medical Laboratory and accepted by Armament Laboratory:
 - (a) Minimum from any structure behind head to any in front of face: 20 inches.
 - (b) Minimum of this 20 inches behind head: 4 - 5 inches.

Since all gunners had to assume the same position for sighting, all were discommoded.

During elevation of the guns and gunsight, the latter would hit the gunner's oxygen mask and pinch his mask tubing. To be sure, the gunner's head and mask were at an angle to the back of the turret during sighting, leaving barely enough room with extremely careful, slow movements. Turning of the head for scanning, even with the guns horizontal, had to be done similarly. But combat conditions certainly do not permit such movements.

This anthropometric evaluation was confirmed by complaints from both European and Pacific Theaters. The requirement that all bombardment aircrew wear steel helmets for flak protection - quite impossible in the early Sperry upper - enhanced the need for providing more room for the gunner's head and face.

The anthropometric report advocated three remedies all of which were adopted: (1) relocating an obstructive switch on the gunsight; (2) bulging out the turret dome behind the gunner's head; and (3) moving the whole sight assembly away from the gunner.

(3) Vision is obviously a paramount consideration in turret design. Since the gunner must scan wide areas, apprehend his target, and then track it (that is, follow it through his gunsight while adjusting the sight reticles for distance and size of the enemy plane) with both airplanes maneuvering at high

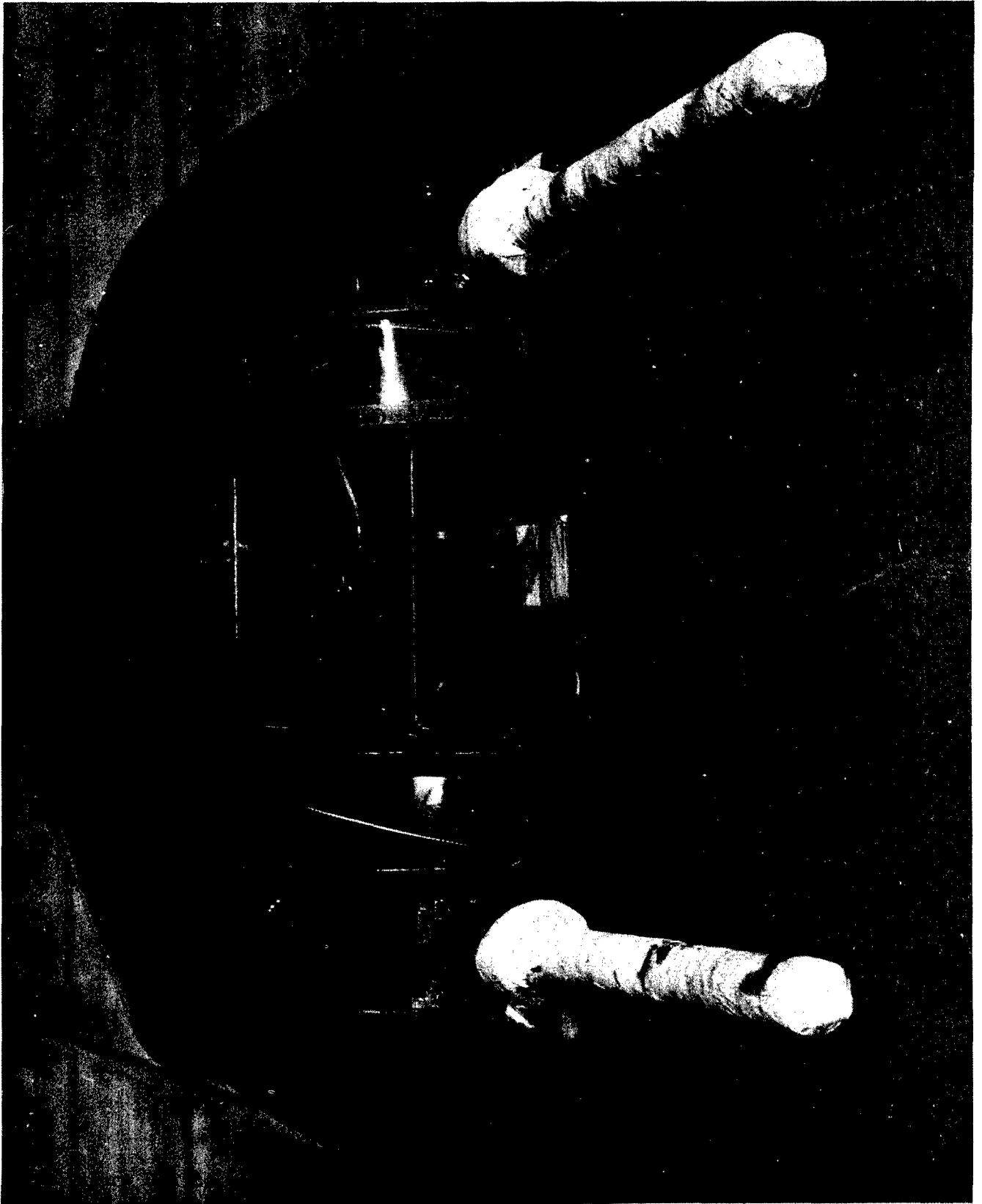

speeds. Since the turret also serves as look-out for the entire airplane, it is imperative to minimize obstructions to the gunner's vision not only through the sighting panel, but also around the entire turret. The gunner should be able to scan by moving his head about within the turret, since continuous movement of the turret for scanning shortens the life of the electrical system and burdens turret maintenance facilities, in addition to slowing the airplane when the guns project into the airstream. One of the two major criticisms of all early American turrets by a British observer was that "the entire subject of the scanning field in each turret had been given too little consideration."

Not only was visibility evaluated in routine anthropometric examinations of gunner's accommodations, but special studies were made comparing the field of vision afforded by various turrets and recommending specific improvements.

The following are a few examples of deficient visibility in turrets, some of which were later corrected:

a. Sighting Difficulty in the Sperry Upper

The earliest Sperry turret domes (Figure IV, 53) consisted of a number of panes of plexiglass, joined by metal strips running horizontally and vertically. In combat and during fatigue tests conducted by the Aero Medical Laboratory, the target was frequently lost in the blind spots caused by these obstructions. The horizontal ribs were worse hazards than the vertical, since the latter might be partially seen around, due to the spacing of eyes and by lateral movements of the head.

When these difficulties were pointed out, subsequent domes eliminated first the horizontal and later most of the troublesome vertical ribs, with the result that late models have greatly improved visibility.

b. Scanning difficulties in Martin Upper

One of the few faults of a generally successful turret has been a blocking of the gunner's lateral vision by the gun and a severe reduction in downward field of vision by his position, sitting low in the turret. As an RAF observer pointed out in 1942, the chief defect of the turret was that the gunner could not see anything not diving on him. Unfortunately, the construction of the turret has prevented remedial action, although it is possible that, had the importance of vision been recognized from the beginning a satisfactory design might have been adopted.

c. Comparison of Vision in Consolidated and Emerson Tail Turrets.

Vision, both for scanning and sighting, was unsatisfactory in the Consolidated turret (Figs. IV, 54 & IV, 55). For scanning, the gunner

PRINCIPAL STRUCTURES OF THE CONSOLIDATED TAIL TURRET

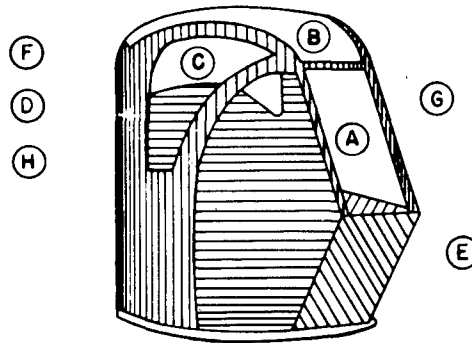

- (A) FRONT WINDOW, BULLET-PROOF GLASS
- (B) TOP CENTER WINDOW, PLEXIGLASS
- (C) SIDE BULKHEAD WINDOW
- (D) TURRET OUTER SHELL
- (E) AMMUNITION BELT
- (F) METAL CONSTRUCTION (BETWEEN TOP WINDOW AND SIDE BULKHEAD WINDOW)
- (G) METAL BAND, TOP OF GLASS WINDOW
- (H) METAL BAND, EDGE OF PLEXIGLASS OUTER HOOD

4533E-A M L

FIGURE IV, 54

VISIBILITY FROM CONSOLIDATED TAIL TURRET,
ANTERIOR HEMISPHERE

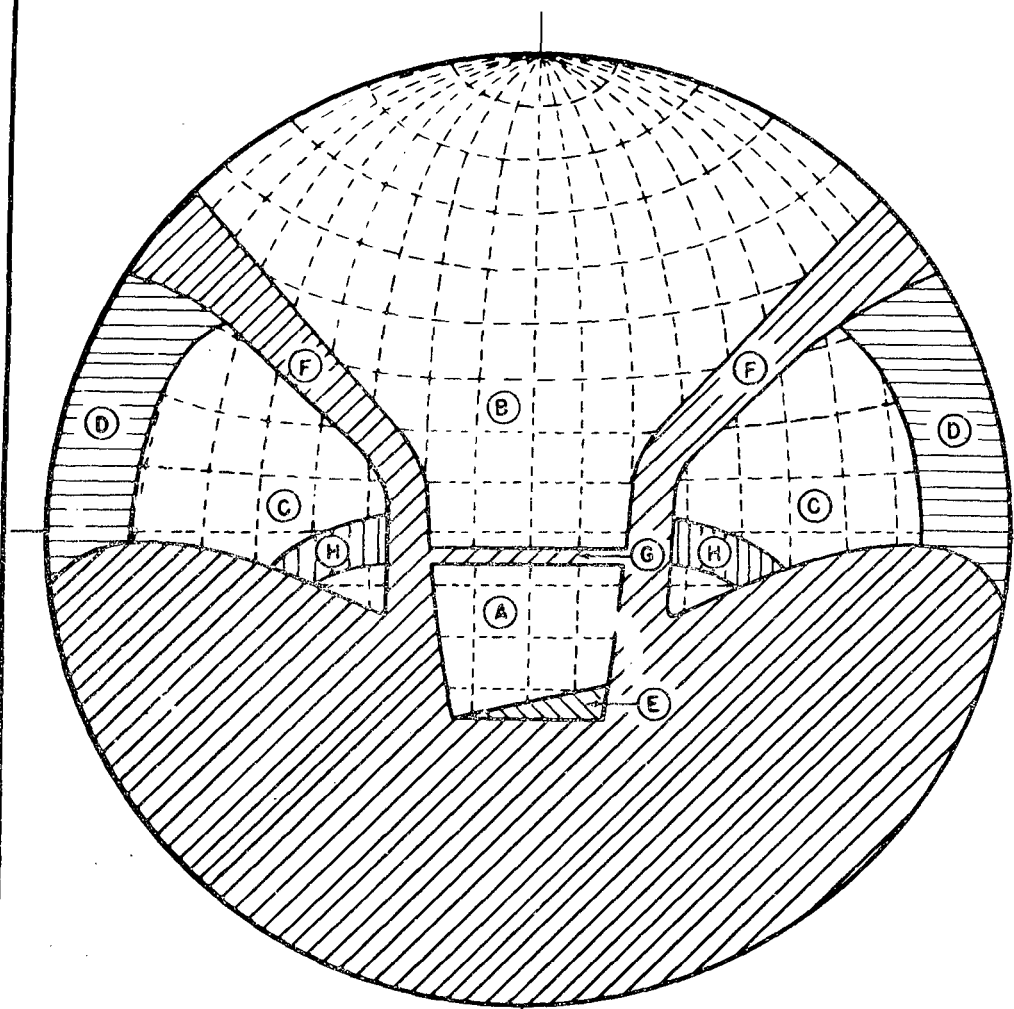

4533D-A M L

FIGURE IV, 55

FOR KEY SEE FIGURE IV, 54. THE PROJECTION IS SIMILAR TO THAT OF A HEMISPHERE MAP PROJECTION. THE CENTER OF THE SPHERE IS THE POSITION OF THE GUNNER'S EYE.

sat low in the turret, bringing his eye very little above the beginning of the transparent surface and limiting down vision; the turret dome consisted of plexiglass panels jointed by metal strips; and the total field of vision was reduced by side bulkheads and other obstructions. As for sighting, targets became lost in a horizontal metal band at the top of the sighting panel (exactly as in the Sperry upper turret noted above), and the field of vision fell considerably short of the field of fire of the guns.

These shortcomings were pointed out to the Armament Laboratory, but before they could be corrected, production of the Consolidated turret ceased. The Emerson turret, which replaced it, avoided the previous errors, and as a result had excellent visibility (Figs. IV, 56 & IV, 57).

(4) Safety includes armor protection, ease of entrance and exit, and possibilities for emergency escape. All crew members require armor protection in some form from flak and if possible from bullets. "Flak suits" (armor vests) may be worn; armor plate or bullet-proof glass may be provided; or crew stations may be designed to utilize heavy construction of the airplane as protection. Ease of entrance may be critical if the gunner must assume his position quickly, as, for example, to replace a wounded man; ease of exit is vital at all times, especially to aid another crew member and to escape when the airplane is seriously damaged. Escape in case of ditching or crash landing, which requires openings on top of the airplane, is for the most part a problem not peculiar to turrets, since most turret gunners are instructed to assume other stations when a crashing landing or ditching is imminent (approximately 90% of ditchings allow ample time for the crew to be warned and to assume ditching stations). However, some turret gunners, notably in the B-29 tail, routinely remain in their turrets, as might others if direct escape were possible. As for parachute escape, it is ironic that tail and ball turrets, the best positions in the airplane for direct escape - since the flyer will not hit any portion of the airplane - afford inadequate provisions or none at all for so doing. The accelerative forces encountered in spinning airplanes make movement so difficult that immediate escape is unquestionably superior to arrangements where the gunner must leave his turret and make his way to an escape hatch.

The following are presented as examples of anthropometric concern with safety provisions in turrets:

a. Armor Protection

(1) Location of armor plate in Bendix upper. In July, 1943, the Aero Medical Laboratory was requested by both Bendix and the Armament Unit, Production Division, to advise concerning a proposed installation of armor plate within the box casting, between the central control column and the gunner. Anthropometric findings were that at least 50% of AAF flyers in light clothing and virtually 100% in heavy clothing either could not fit into the turret at all or could not operate it efficiently; that wearing of an oxygen mask was precarious; that no

105267

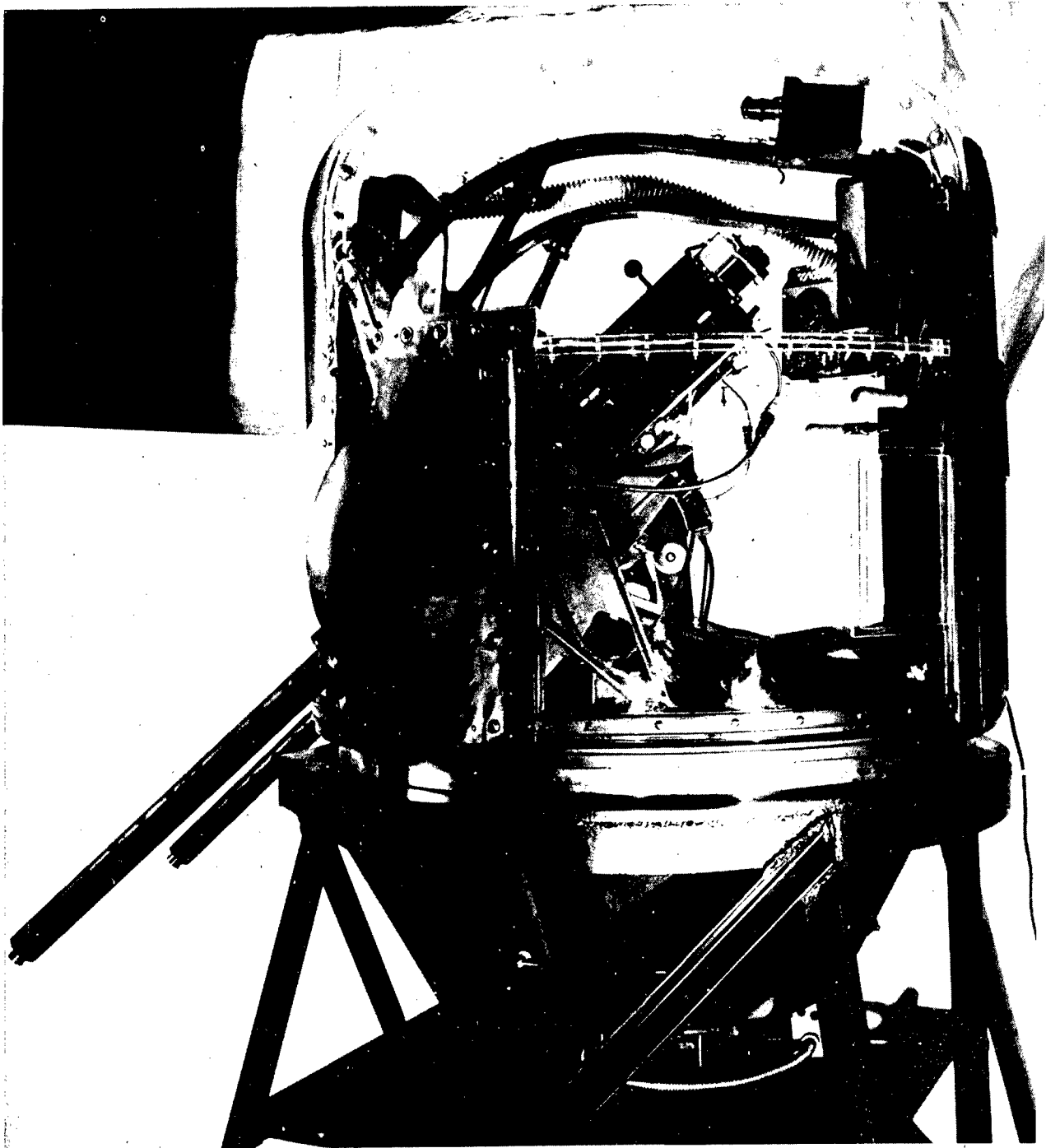

Figure 3

Emerson Experimental Tail Turret, Model 111
(for B-24 plane)

View from left side

Figure IV. 56

5th Jan 43

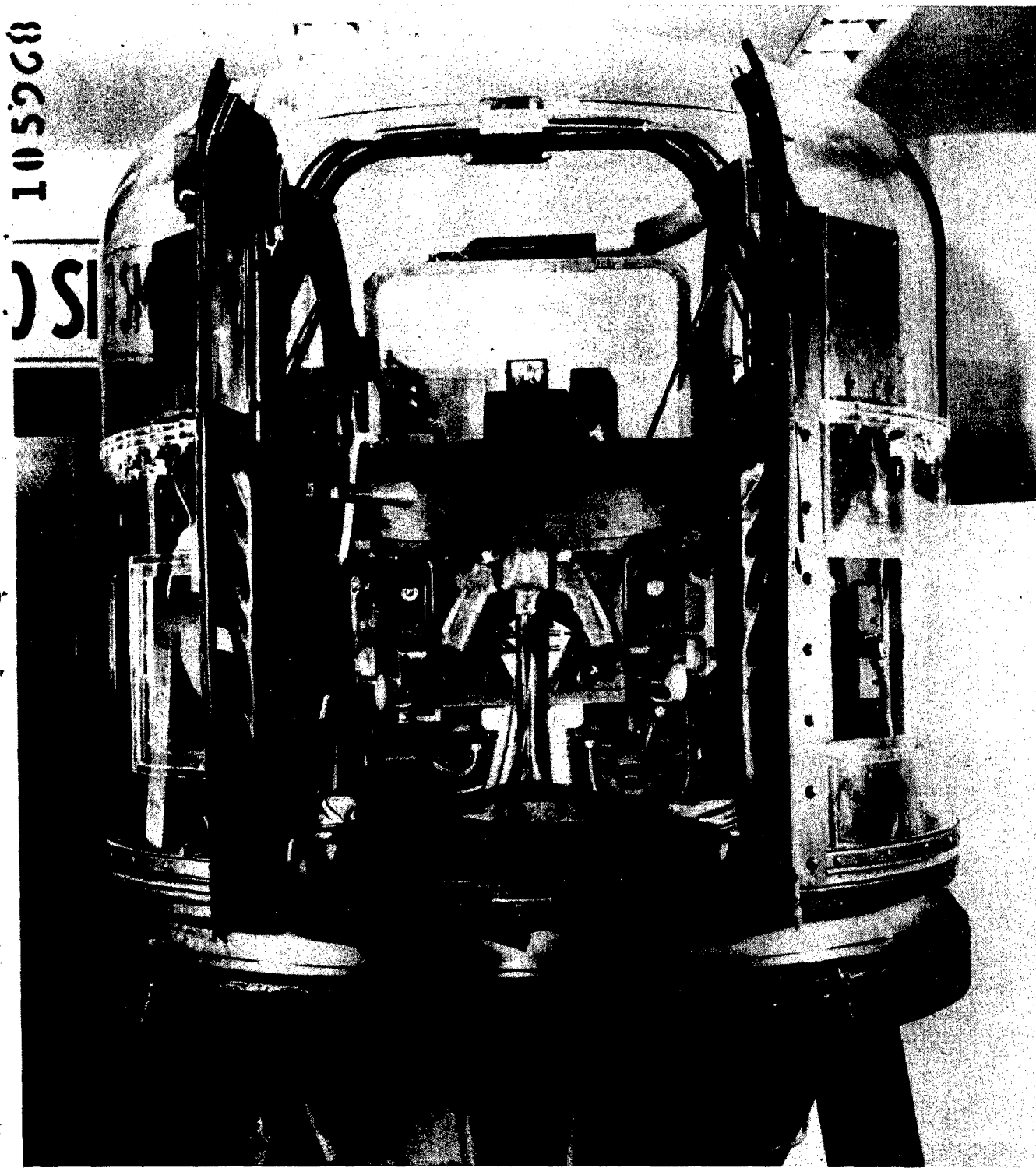

Figure 4

Experimental Tail Turret, Model III
for B-24 Bomber

Turret assembly, looking aft

standard parachute could be worn in the turret; that flak suits and helmets were becoming required for wear in combat; and that armor plate in the proposed position would enhance all the above difficulties. It was accordingly advised that the proposed location was not feasible, and an alternative location (along the turret ring, below the sighting panel) recommended which would provide substantially equivalent protection without interfering with vision or aggravating the already serious cramping within the turret. This recommendation was adopted.

b. Steel Helmets for Turret Wear

Although the anthropometric study of steel helmets for turret wear resulted in fitting the former to the dimensions of the latter, it illustrates the problems of integration into which the study of gunner's accommodations ramifies. When steel helmets for aircrew became required for combat wear, data obtained by the Aero Medical Laboratory on head size of AAF flyers, turret clearances, and tests of two proposed helmet models in the principal turrets aided in the decision to standardize two helmets: one for aircrew in general and a smaller one for use in turrets and other cramped quarters. This study will be discussed in more detail later.

(2) Difficulty of entrance and exit

a. Difficulty in entry in Martin and "Martin Junior" turrets.

The Martin upper turret (for B-24 and B-26 airplanes, later used in the B-32) posed a formidable problem of entry to an unaided gunner wearing heavy clothing and a seat parachute. Exit was easy, since the entire seat could be unlatched and swing down. The entrance was restricted anteriorly by a metal foot rest and ammunition boxes, and posteriorly by the seat, which hung down; the presence of gun handles above enjoined slow, careful head movement; nor were handles or straps provided to help the gunner pull himself up and retain his position while reaching underneath himself to secure the seat.

The Martin "Junior", for the A-30 airplane, was the same turret with only two modifications, both of which enhanced the gunner's difficulty on entrance: a reduction of 5 inches in over-all diameter and a fixing of the foot bar, originally adjustable, 6.5 inches below the seat level, thereby reducing the opening available for entry.

These difficulties, later confirmed by combat reports, were pointed out and specific recommendations made for correction. Entrance grips were eventually added. Although the shortcomings of the Martin "Junior" were acknowledged by the manufacturers, production requirements precluded redesign.

b. Impeded exit in Emerson tail turret. Insufficient foot space was one of the few defects in the Emerson nose and tail turret for

the B-24 airplane. The difficulty of wearing heavy flying boots, Type A-6, was pointed out - in respect to spatial accommodation rather than to ease of exit, however - in two Memorandum Reports, in 1942 and early 1943, and in a trip to the manufacturer's plant in March 1943. Although the condition was acknowledged to be undesirable, it was stated that the need for fitting mechanical items into a limited space precluded modification.

In 1944 an 8th Air Force gunner was interviewed who reported that he had tried to leave the turret rapidly in an emergency, but could not, his foot catching in each of six attempts to free himself. He wore a small shoe, size 7, with a medium-size A-6 boot. Luckily, the emergency passed, or the gunner might have gone down with the plane.

c. Difficult entry and exit in Emerson nose and tail ball. At the end of the War, in keeping with the trend - to be discussed later - toward smaller turrets, a small ball turret was built by Emerson for the nose and tail of the B-32 airplane. Not only were inadequate hand-holds provided, but A-6 boots invariably became caught under a transverse bar. The excessive difficulty of entry and exit encountered at such a late stage in turret development indicates once more that eternal vigilance is the price of gunners' safety.

(3) Emergency Escape from Turrets

a. Tail turrets. No standard AAF tail turrets except the B-29 tail sighting station permits direct escape, whereas the RAF expressly stipulates (in the British equivalent of the AAF Handbook) that "the door of tail turrets shall be capable of being opened when on the beam (i.e., full to side) to facilitate the escape by parachute of the tail gunner." (Ministry of Aircraft Production, Air Publication 970, par. 57). Anthropometric reports have continually recommended the adaption of similar safety measures for AAF turrets, but with little success. Provision for direct escape was incorporated in experimental models of the Motor Products tail turret but deleted from the production model.

b. Ball turret. Although the ball turret was an excellent position from which to leave the plane by parachute escape, early models virtually precluded the wearing of a parachute, since any bulk under or behind any but the smallest gunner pushed his head far beyond the gunsight and made sighting impossible. Moreover, the turret was so crowded that there was little or no space to stow or to attach a chest parachute.

Anthropometric recommendations were to drop the turret seat or to bulge out the door behind the gunner's back. Both suggestions were tested experimentally, and the former was adopted, with the result that direct parachute escape became generally feasible.

Now that the chronological and analytical stages of the anthropometry of turrets have been discussed at some length, the entire procedure as applied to one turret, the Sperry upper, and to a comparison of three competing turrets, will now be presented.

LOCAL CONTROL

Gunners' Accommodations in the Sperry Upper Turret, Type A-1

The Sperry upper turret (Figs. IV, 52, & IV, 53), used with great success throughout the war in the B-17, was a sturdy, rugged turret in which the gunner stood upright while sighting. In later models, a seat and foot-rests supplanted a webbing strap seat and stirrups for standing. The turret originated in 1940 as a stop-gap, interestingly enough, until the Sperry Gyroscope Company could perfect a remote-control armament system. This was never done in the B-17.

Principles Derived from Study of Sperry Upper Turret

What general principles, both for anthropologist and for turret designer, can be drawn from experiences gained on this turret? Preoccupation with fitting the turret into the airplane on the one hand, and devising ever better (and bigger!) gunsights and fitting them into turrets on the other, had left no room, either in the designer's mind or in the turret, for the gunner. The defects reported in the anthropometric evaluation were obvious to anyone who attempted to operate the turret as a combat gunner would. No elaborate statistics were required to realize that the gunner was intolerably cramped; indeed, since the eye of each gunner had to reach the same level for sighting, the chief fault of the turret, head and face restriction, affected all sizes of gunner equally,

When impaired combat efficiency dictated changes in the turret in the gunner's interest, it was relatively minor modifications rather than a thorough redesign that improved the gunner's lot. Had the designers been acquainted with the gunner's problems from the beginning, losses in efficiency, time, and production need never have occurred.

(1) Obviously, consideration of the gunner as a factor in turret design is the kernel of the whole problem. All else is but refinement; once grasped, this is the principle whence all blessings, in the form of satisfactory gunners' accommodations, flow. And the gunner's needs are indeed modest, compared with the complex mechanical and aerodynamic problems successfully solved in turrets.

(2) Moreover, it is necessary to consider the gunner early in design; because once production begins, the pattern is virtually frozen and is extremely difficult from a design point of view. Thus some simple changes, like moving the roller brackets 2 inches apart, were never accomplished, while others equally simple, like moving the microphone from the pedestal to the hand grips, or eliminating the ribs from the turret dome, or moving the sight forward 3 inches, took months to accomplish after the turret was in production.

(3) A principle which has wide applications in the whole turret project can be stated thus: Production schedules are not an excuse for slighting

design. Although it is undoubtedly easier to preach than to practice this precept, especially in wartime, it has generally been true that "cutting corners" does not pay. Possibly the origin of the Sperry upper as a stop-gap turret, pending development of central station armament, contributed to a feeling that painstaking design or prompt remedy of acknowledged defects were not urgent. But the turret lasted for the entire war, and its total effectiveness would have been far greater had early models accommodated the gunner as well as did the later. A similar situation occurred in the case of the Bendix upper, when deletion of the oxygen system from the B-25 airplane was suggested as a reason disregarding oxygen mask provisions. As predicted by the Aero Medical Laboratory in advocating more room for the wearing of an oxygen mask, the oxygen system was later restored to the B-25. The point is this: while improvements and modifications will always be required in turrets, armament designers will not have to compromise mechanical perfection in later models if they have first accommodated the gunner.

(4) The vital necessity, in evaluating gunners' accommodations, of considering the gunner as wearing all his combat gear and performing all his required movements is clearly demonstrated, as is the need for integration between airplane, turret, and equipment designers. It is not far from the truth to say that no turret presents a problem to most individuals dressed in shirt and trousers — the usual equipment worn in factory inspections. But when bulky clothing, oxygen masks, flak suits and helmets, and parachutes are worn, as they must be in combat, and when the gunner must perform certain operations in the turret, then his problems become acute. Then, too, do differences in gunners' body sizes become critical. Manufacturers should always be furnished by the AAF with complete outfits of personal and accessory equipment kept constantly up to date, and should be familiarized with operational procedures in the airplanes for which their turret is designed.

(5) Specific features and installations of the Sperry turret, rather than its over-all dimensions, have caused its difficulties, many of which were remedied without increasing the dimensions of the turret or eliminating any equipment. It is true that it was necessary to increase the size of the turret dome to provide more head room, and that the restrictions on elbow movement were not corrected; but it is by no means certain that these were inevitable features of the turret, dictated by its dimensions and location in the B-17.

(6) Anthropometrically, several points are worthy of notice.

(a) Breaking down gunners' accommodations into comfort, efficiency, vision, and safety, and subdividing the spatial analysis still further, in terms of lateral, vertical, and fore-and-aft restrictions, enables evaluations and suggestions to be made that have a much better chance of acceptance than would general aspersions on gunners' comfort. By this procedure minor changes which can be incorporated without hampering production can be isolated and followed up.

(b) The subjects used to test turret accommodations should be selected as physically representative of the flyers likely to man the turret. Body size criteria for the selection of all aircrew and of turret gunners change from time to time; whereas the general requirement for interchangeability of crew members is likely to remain. Accordingly,

the subjects chosen should represent a wide range -- 5th to 95th, or 10th to 90th percentiles -- of the existent flying population. It is an ultimate goal of the anthropometric project that neither turrets nor any other crew position need impose size limitations on operating personnel. Until that time, the anthropologist will have to keep informed on the physical composition of the flying population, current directives for aircrew selection, and design and performance specifications of airplanes and turrets.

(c) The striking concurrence of laboratory assessment with independent combat reports is another indication of the soundness of the analytical procedure. Combat performance is the ultimate proof of the turret pudding.

(d) Elaborate use of statistics is unnecessary. Averages and approximate percentages have been sufficient for the purpose, which is essentially to buttress common sense; to indicate the relative urgency of various suggested improvements; and to serve as a general guide in the selection of gunners to operate the turret.

(e) The terminology employed should be engineering rather than anthropometric. Thus, dimensions should be denoted "knee height" and "shoulder breadth" rather than "patella height" and "bilateral diameter," and expressed in inches rather than in centimeters. Even when carefully defined, technical anthropological language has been found to interpose a serious barrier to the acceptance of the gunner's place in turret design.

A Comparison of Gunners' Accommodations in

Three Tail Turrets for the B-24

Another example of the application of the anthropometric procedure detailed above is afforded by the comparison of gunners' accommodations in the three tail turrets for the B-24: the Consolidated (Fig. IV, 49), earliest of all, and its two successors, the Motor Products and the Emerson (Figs. IV, 56, and IV, 57). The Emerson was later used in the B-24 nose as well as in the tail position. Each turret had been analyzed individually, and the comparison allowed certain general conclusions to be drawn which were later incorporated in Technical Note 49-2, summarizing the findings of the entire anthropometric turret study.

As inspected in January 1943, the Emerson turret embodied two anthropometric suggestions made to Emerson representatives while the turret was still experimental. These were (1) increased amplitude of adjustment in the turret's compensating sight-and-seat mechanism (which maintains a constant distance between the two at all elevations of the guns) to accommodate the range of sitting heights of AAF flyers; and (2) a reshaping of the upper rear cross member of the turret frame so that it no longer hit the back of the gunner's head. The Motor Products model was a first attempt to replace the admittedly unsatisfactory Consolidated turret, while retaining many of its features to facilitate production and installation. Later versions of the Motor Products turret, as finally standardized, afforded much better accommodations for the gunner; and, like the Emerson, incorporated anthropometric suggestions made directly to the designer. A large man wearing heavy clothing plus seat parachute could operate the later turret comfortably, and his field of vision was good.

Examination of the comparison of the three turrets confirms all the principles outlined above for the Sperry upper turret. Especially are two points clear: (1) the Consolidated turret, recognized as unsatisfactory from the beginning, had a long life with very few modifications, because it was the first and for a long time the only tail turret the AAF had. As in the case of all turrets, once production has begun, and especially if replacement is contemplated, even imperative changes may never be made. (2) The diversity of solutions of the B-24 tail turret problem, especially the fact that each of the three turrets has its own virtues and defects, demonstrates dramatically the truth of the proposition that particular (and, if caught early enough in the turret's evolution, often rearrangeable) installations, rather than over-all turret dimensions, are the source of the gunner's difficulties.

Selection of Gunners

Examination of all standard and several prospective turrets yielded the percentages of AAF flyers accommodated by each, and the scatter diagrams afforded reasonable approximations to the upper limits of height and weight of gunners who could operate the turret efficiently.

Thus, for example, the Martin upper turret imposed a range of nude sitting heights between 35 and 37.5 inches on gunners wearing winter flying clothing (either shearling or electrically heated suits), such range occurring between 65 and 72.8 inches in stature. In the same turret, the nude breadth across the elbows should not have exceeded 15.5 inches, if shearling was to be worn, or 17.5 with the electrically heated suit. In the former case, the weight would be below 163 pounds; in the latter, below 188 pounds.

Again, the gunner in the Sperry upper should not exceed 70 inches or 165 pounds; nor should the gunner in the Bendix upper exceed 150 pounds in weight. Two gun stations — not turrets — which would accommodate tall gunners were the B-17 and B-26 tail positions, but both imposed limitations on weight well below 180 pounds.

These limits were put to use in January 1943, when the Office of the Air Surgeon, responsible for establishing physical criteria for aircrew selection, requested the opinion of the Aero Medical Laboratory on a proposed change of the upper limits on gunners' height and weight from 70 inches and 170 pounds to 73 inches and 180 pounds. The Aero Medical Laboratory recommended that the proposed change not be adopted, inasmuch as it was virtually impossible for individuals 72 inches in height and 180 pounds in weight to operate existing turrets — upper, ball, or tail — comfortably and efficiently under combat conditions — that is, wearing heavy winter flying clothing and oxygen masks, even without parachutes — for several continuous hours. In fact, great difficulty was experienced by individuals at the existing upper limits. Although some aberrant gunners above 70 inches and 170 pounds might fit, they would be too few to warrant the training of large numbers who would not. And although redesigns of current turrets were in prospect and might accommodate larger individuals in the future, the equipment actually in service and in production at a given time is the proper basis for selecting gunners.

The Armament Laboratory concurred in this negative recommendation, since combat experience had proved the necessity for interchangeable gunners. If gunners were to be able to operate any of several turrets, large individuals should not be selected and trained, even though they might fit one or two existing turrets.

It was therefore concluded that changing the criteria of selection would increase not the supply of gunners, but the number of misfits; and that the best way to increase the supply of gunners was to redesign the turrets.

This recommendation of the Aero Medical Laboratory was accepted by AAF Headquarters, and the limits of 70 inches in height and 170 pounds in weight were retained until considerably later in the War, when roomier turrets became standard.

Visits to Turret Plants

All standard turrets and several experimental models were thus analyzed, but the writing of reports and discussions with manufacturers' representatives on current and even experimental models, it became apparent, could do little more than modify minor details of finished products. By the time a turret has reached even the experimental stage, its design has virtually crystallized. Major changes, though demonstrably desirable, cannot be effected because of the interrelationships between the component parts of a complex machine. The time to effect changes is before the wooden mock-up, or even before the blue-print stage.

As stated above, designers should have the gunner in mind constantly as an integral part of the turret; and their concept should be functional, in the sense that both gunner and turret will be the final product as it enters combat.

In thorough agreement with this point of view, the Armament Laboratory considered that the results of the anthropological study could be brought home to manufacturers best by personal visits to each turret manufacturer, in which the anthropologist could discuss in detail the analysis of each turret and demonstrate the difficulties encountered. In all, visits were made to nine plants in 1943. A complete kit of personal equipment was demonstrated, and, as might have been suspected from turret arrangements, proved to be a revelation to most manufacturers, who had had little conception of the amount or nature of the gunner's elaborate gear. For example, the gun-charging handle in the Sperry upper turret would not permit passage of a hand wearing standard flying gloves. A larger leather handle was immediately substituted, to be shortly replaced by a ball and cord device much easier to grasp. Arrangements were made for supplying personal equipment kits to all manufacturers for experimental design purposes. Moreover, a few employees typical of AAF gunners were selected and measured, and their measurements located in the AAF body size series. Thus, design engineers were shown the practical use of the percentile distributions and were furnished with living examples who could be dressed in the newly-supplied flying equipment and whose difficulties could be translated into percentages of AAF flyers discommoded. Interestingly enough, the Norge Company had already been using an employee as a subject, but on measurement he proved to be small, falling well below the AAF average. A larger subject was therefore selected and measured.

In addition to furthering consideration for the gunner in designers' minds, mock-ups of turrets under development at each plant were analyzed by the usual procedure, except that one subject approximating the average AAF height and weight (which are 69.2 inches and 154 pounds) was used. As a result of these analyses and discussions on the spot, many suggestions were put into effect in the mock-ups while there was still time.

These anthropological visits to turret manufacturers were then to the mutual advantage of the AAF and to the manufacturers, in letting each know the other's interests and problems. The manufacturers received indoctrination

in a point of view, were shown and supplied with equipment necessary for satisfactory design, were furnished subjects located in the AAF series, and received comments on the adequacy of gunners' provisions in their turrets, as derived from laboratory analyses, combat reports, and questionnaires. In turn, the AAF anthropologist received valuable suggestions for improving the utility of his contributions. For example, a simpler and more easily understood presentation than the original body size percentile memorandum report was almost universally desired. Accordingly a simplified presentation, in graphic form, containing clothing increments and eliminating the technical terminology, details, and correlation tables, was subsequently prepared and distributed to all turret manufacturers. A few pages are presented in the Appendices.

Improvement of Production Turrets and Criteria for New Designs.

The turret problem confronting the anthropologist, it will be recalled, is four-fold: evaluation of gunners' accommodations in production turrets, establishment of physical criteria for gunners to operate them, improvement of production turrets, and the formulation of human standards for new designs. The first two have been discussed in some detail, while the third task has been mentioned from time to time in connection with specific turrets.

In general, data on the adequacy of gunners' accommodations, as obtained from a variety of sources - anthropometric examinations, questionnaires devised by the Aero Medical Laboratory and answered by combat gunners, overseas reports, Unsatisfactory Reports, and interviews with gunners - were analyzed and brought to the attention of armament engineers at Wright Field and in the industry, with detailed suggestions for remedy of unsatisfactory conditions. Many of the recommended modifications were incorporated during the course of production, resulting in significant improvement in later models.

No standardized procedure can be set for every case, but diligence in gathering information and perseverance in following up recommendations are prescribed for the anthropologist undertaking to improve production turrets. Wartime experience has shown that written reports, especially on projects initiated by the Aero Medical Laboratory, are much more likely to be effected when supplemented by personal contact. The trips to turret manufacturers served such a function and by disclosing the type of data and presentation required by the industry, led directly into the fourth and most important function of the anthropometric turret project; namely, the establishment of guiding principles for future design. These principles are embodied in two reports, one on head and eye movements in sighting and the other on gunners' accommodations in local-control turrets:

Sighting Movements in Turret Design

At the request of the Glenn L. Martin Company, a study was undertaken on head and eye movements in sighting. In all turrets, the gunner's normal eye position is fixed by the location of the gunsight, with seats and other supports being adjustable vertically to bring the eye of gunners of different sitting heights into line with the gunsight. But the location and type of movement of the gunsight, as well as the design of the turret sighting panel determined thereby, should be based on the normal position and movements of the gunner's head and eyes in sighting! Precise knowledge of the latter was lacking, with several misconceptions current, such as that when the gunner is looking straight ahead at various angles above and below the horizon, his earhole describes a circular course; and that the ear-hole is the pivot about which head and eyes rotate. As a result of the absence of exact information, insufficient space was allowed for the head in most turrets, and gunsight movement during elevation and depression of the guns was frequently fatiguing to follow.

AAF Technical Report No. 4990, dated 17 August 1943, "Eye Movement in Sighting as Related to Design of Turret Sighting Panels," supplies the required

data and integrates it with gunsight movement and sighting panel shape, the relationship between which had been worked out on theoretical optical grounds by the Armament Laboratory in Technical Report No. 4887, dated 4 February 1943, "The Design of Turret Sighting Panels." The two Technical Reports should always be read together and are presented (the former in full, but only the relevant portion of the latter) in Chapter VII. The theoretical equations contained three unknown factors which prevented their practical utilization: (1) gunsight movement based on the gunner's sighting operations; (2) location of one focus of the ellipse considered to be the best panel shape optically; and (3) location on the ellipse of a point determined by the gunner's head height. Technical Report 4990 defines all three unknowns and corrects the misconceptions mentioned above.

Technical Report 4990 has been distributed through the Armament Laboratory to turret and glass manufacturers, and its principles have been incorporated into actual turrets - constituting, for example, the basis of gunsight movement and sighting panel shape in the Martin experimental "streamlined" turrets for the B-32 airplane.

Gunners' Accommodations in Turret Design

An Engineering Division Technical Note is a publication designed to acquaint industry with the AAF's version of good manufacturing practice. It comprises desirable and attainable features rather than mandatory specifications and is thus eminently suitable for conveying human requirements to turret designers. Requirements for gunners' comfort, efficiency, vision, and safety derived from the anthropometric study of turrets are summed up in simple engineering terms in Technical Note 49-2, dated 8 January 1944, "Gunners Provisions in Local-Control Turrets."

Technical Note 49-2 has been distributed through the Armament Laboratory to all turret manufacturers, and no major revisions have been indicated by developments since it was published. The last sentence should be deleted, inasmuch as more detailed dimensions have been established for catwalks and escape hatches. Subsequent experience with central fire control armament has demonstrated that as far as the gunner's needs are concerned, there is no essential difference between local-and remote-control turrets, and that the title might well be changed to "Gunners' Provisions in Turrets."

TURRET ANTHROPOMETRY FROM 1944 TO THE END OF THE WAR

With the publication and distribution of Technical Note 49-2, early in 1944, the major portion of the turret study was finished. For four original problems had been met, a standardized analytical procedure had been devised, and subsequent activity has consisted of its application to particular problems. In the opinion of the Armament Laboratory, "The anthropometric studies were a success because several specific adverse conditions were improved on production turrets... (and) much needed attention was drawn to the necessity for comfort of gunners." One manifestation of this successful indoctrination of armament engineers has been the development of the split gunsight in which the bulky computing apparatus is placed outside the turret and connected by cables to the small optical portion within a much more efficient arrangement for the gunner. The body size distributions of AAF flyers are now included in specifications for all new turrets, and Aero Medical Laboratory representatives are routinely requested to inspect drawings, wooden mock-ups, and pre-production versions of experimental turret models. Most gratifying of all has been the enthusiastic reception by combat gunners of turrets or features of turrets in which anthropology has played a part.

It remains to outline the main trends in turret development and in the anthropometric turret study since the completion of its first phase, and to derive general principles and conclusions from the whole project. Subsequent turret evolution has been along two distinct lines, local control turrets and central station fire control, to be discussed in turn.

LOCAL CONTROL TURRETS

From the limited anthropometric point of view—and, for proper perspective, it should be borne in mind that anthropometry has been a very minor consideration in the evolution of aircraft armament as a whole ---, the recent history of local control turret design has been anti-climactic. Under the pressure of combat needs, and against the desires of both the Aero Medical and the Armament Laboratories, the whittling away of the gunner's hard won gains was accelerating by the end of hostilities. The pendulum was swinging from arming the bomber for defense, to increasing its speed for offense; and from consideration of the crew, including gunners, to emphasis on airplane performance.

In addition, the fact that bombers were being downed by anti-aircraft rather than fighter planes worked against the gunner, since turrets were of no avail against flak, and the temptation was strong to eliminate them or reduce their size and weight. Against this policy little headway was made by the argument that so long as gunners are retained, their welfare should not be compromised.

Armor deletion. The most common method for reducing turret weight was to delete armor protection, including bullet-proof glass. Armor plate was removed from the Martin upper; the Sperry upper substituted a "swiss-cheese" pedestal of light metal for the heavy plate protecting the one crew member of the B-17 who could not wear a flak suit; a version of the Motor Products tail turret (made by the Southern Aircraft Corporation) eliminating armor protection

was standardized; and two nose and tail ball turrets, the Emerson (Fig. IV, 43) for the B-24 and the Sperry for the B-32, were adopted, with markedly reduced armor protection. Gunners thus subjected to increased flak with decreased protection reacted strongly. Sperry turret gunners would amass as many flak suits as they could lay hands on, and would stand on them, more than offsetting the intended weight saving!

Size reduction. Over-all turret size and the room available to the gunner were also reduced. The Martin "midget" turret had not been adopted in 1943, but in 1944 and 1945 the two nose-and-tail ball turrets mentioned above, of which that for the B-24 especially constricts the gunner, superseded the far roomier Emerson nose-and-tail turret. Even more radical attempts to reduce turret size in the interest of airplane speed were the proposed Martin "streamlined" and later "flush" turrets for the B-32.

Turret prospects. It is likely that the local-control turret as seen during the second World War has passed its prime. Refinement and application of existing principles can be expected during the operational life of conventional bombers, both experimental and in production, but future high-speed aircraft will probably incorporate remote-control armament. However, as will be shown in the next section, this emphatically does not mean that gunners' accommodations may be ignored or slighted. Looking still farther ahead, guided missiles may eventually supplant piloted aircraft; but even in this case, a man must still do the guiding and must be provided with efficient working conditions.

REMOTE-CONTROL TURRETS

The essential difference between local and remote control turrets is that in the latter, the gunner does not move with his guns, in either azimuth or elevation, but operates the sight and other controls from a separate station. Central fire control was developed as the culmination of convergent trends in aircraft and armament evolution during the late 1930's. Aircraft designers were working toward aerodynamic streamlining and cabin pressurization, whereas armament engineers desired a reduction in gunners, a more complete coverage of fire around the airplane (by locating the guns outboard), and the employment of several guns on one target.

Bendix lower. The first remote-control turret to achieve large-scale production was the Bendix lower, indirect-sighting turret, used for a time in the B-25. Figure IV, 58 illustrates the gunner's chest rest, against which he leaned while sighting through the periscope.

From the very beginning, the turret had numerous defects; for example, the periscopic sight had too restricted a cone of vision, the gunner was uncomfortable, could not maintain the kneeling position when the plane was taking evasive action, and had no indication of the direction in which his guns were firing.

At least one attempt was made to salvage the turret. At the request of the Armament Laboratory, an anthropometric examination was made in 1942 and indicated that a redesign would be feasible. Within the existing dimensions of the turret and gunsight, a gunner of average size could operate the turret comfortably while rotating, thereby keeping oriented in relation to his guns. The minor changes in seat, gunsight, and other structure necessary to effect the redesign were outlined and seemed reasonable to the Armament Laboratory, but the project was cancelled for other reasons. Waist guns shortly thereafter replaced the Bendix lower in the B-25.

Central Station Fire Control in the B-29. The General Electric central fire control system in the B-29 consists of a top, midline sighting station between two side sighting stations in a single cabin compartment, plus a tail gunner in a separately pressurized compartment. Gunners' accommodations were first inspected anthropometrically in May 1944, at the request of the Armament Laboratory, in an early production version of the B-29. Attempts had been made in 1943 to incorporate the anthropometric findings on local-control turrets into sighting stations as well, but armament engineers felt that inasmuch as the gunner was operating within the airplane cabin, the principles of local-control turret accommodations did not apply. The effects of slighting the gunner in initial design became apparent when unsatisfactory reports were received on all four sighting stations from gunners in training.

As originally constructed, the top sighting station (Fig. IV, 59) had no vertical adjustment to bring the eye of gunners of different heights to the gunsight level — a fairly elementary consideration which had long been

102324

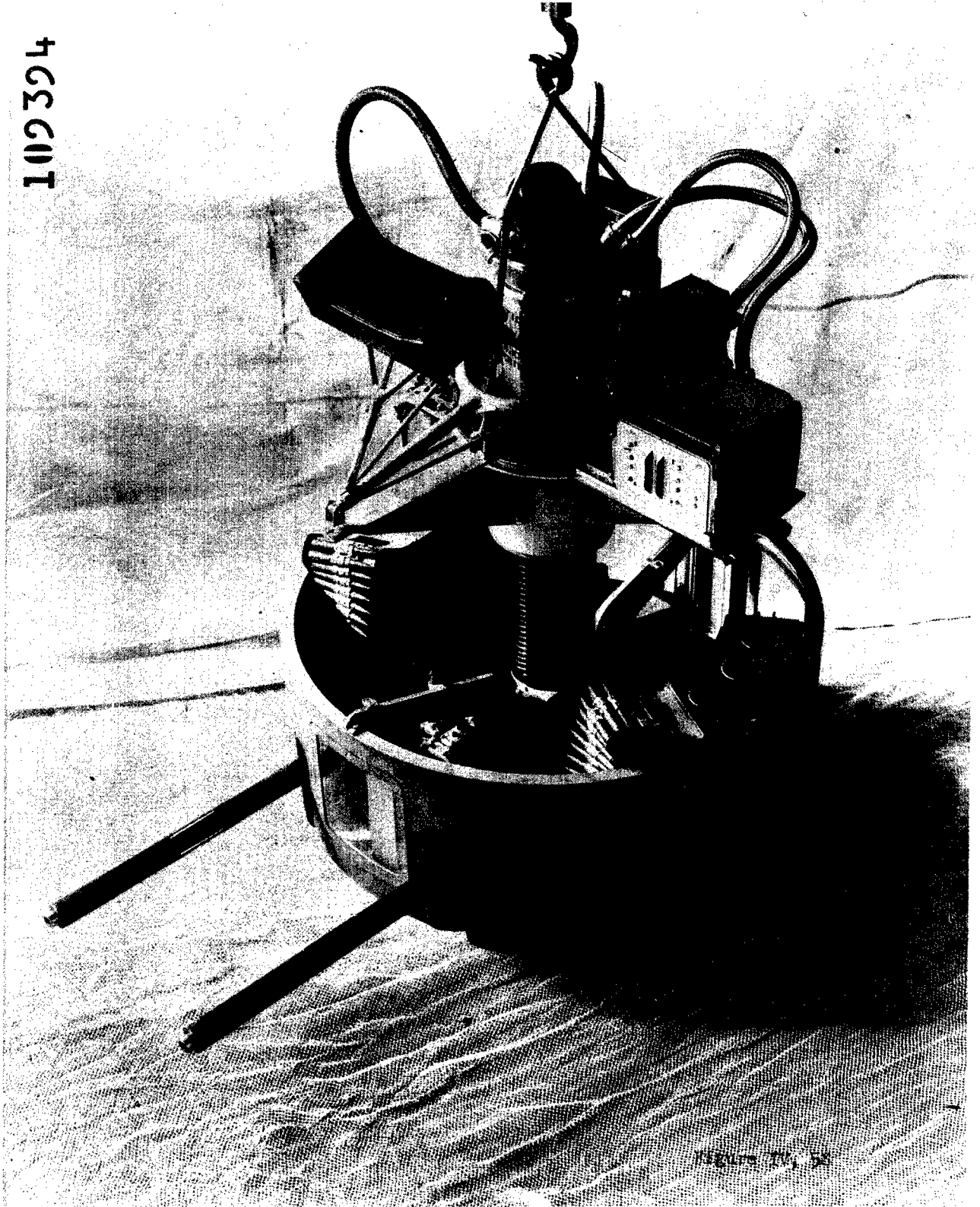
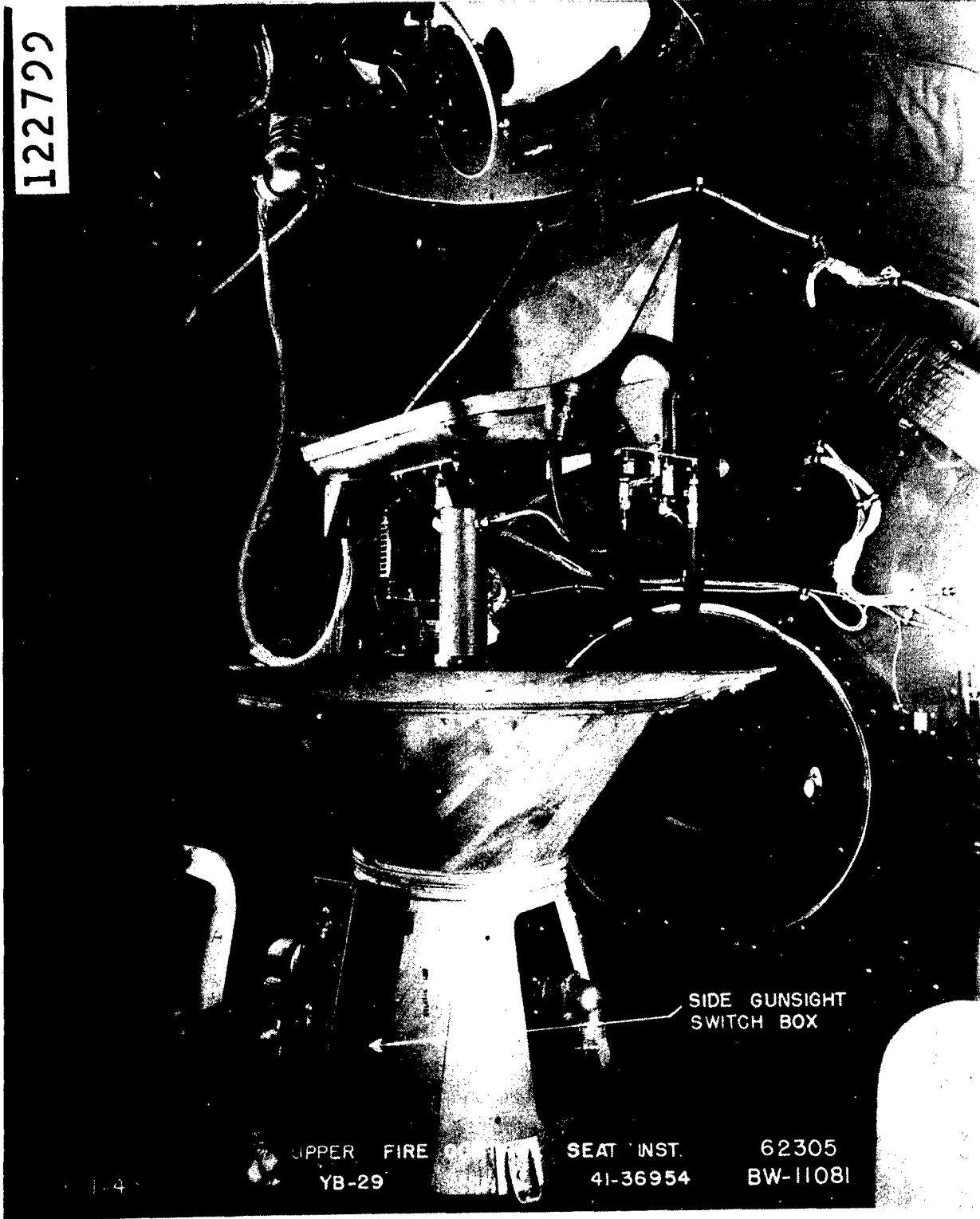

Figure 7A, 2

122799



SIDE GUNSIGHT
SWITCH BOX

UPPER FIRE CONTROL
YB-29

SEAT INST.
41-36954

62305
BW-11081

Figure IV. 59

accepted for a local-control turret and for most other aircrew stations as well. Moreover, the gunner could not wear a back parachute, and his head and face were severely cramped. Gunners' provisions in the side sighting stations (Fig. IV,60) were as bad as or worse than those encountered in any previous turret: the gunner had insufficient room for scanning, sighting, or wearing a flak suit, and had to remove his safety belt to assume his operating position. Several gunners were lost because they were not wearing safety belts when their sighting blisters blew out. And despite the stipulations in the AAF Handbook and Technical Note 49-2 concerning interchangeability and the ready removal of casualties from turrets, the B-29 tail gun compartment prevented access to the gunner by another crewman.

All of the above shortcomings were pointed out by the Aero Medical Laboratory and acknowledged by the Armament Laboratory, which had constructed a mock-up of an improved side station. But except for a minor change in the top station (the addition of 2 1/2 inches of vertical adjustment, where 6 were needed), the exigencies of production in May and June 1944 prevented any modifications whatsoever.

"689" inspection of the B-29. In July, 1944, the Engineering Acceptance ("689") Inspection of the B-29 was held at Wright Field. Airplanes had been produced and crews had been training in them for months before the inspection, so that the scope of the Board's powers was limited. Again the Aero Medical Laboratory submitted its recommendations and received concurrence. In addition, a special presentation of the same data was made to the Production Engineering Section, responsible for introducing modifications into production airplanes, and again concurrence was received. But despite this general recognition of the inadequacy of gunners accommodations, production requirements once more proved to be an insuperable obstacle to immediate correction.

Modification of sighting stations. But as combat operations succeeded training, the number and intensity of adverse reports increased until modification of all four stations became imperative. These changes were based on anthropometric advice. In February 1945, the top station was redesigned, allowing the gunner to wear a back parachute, removing some obstructions to his head and face, and incorporating a 6-inch vertical seat adjustment. In March, the side sighting stations were completely modified to provide more room for the gunner, thereby enabling him to sight and scan more efficiently and to wear his safety belt at all times. Figure IV, 60 illustrates features of the anthropometric analysis of the modification mock-up. And finally, the tail gun position was revised to permit the rescue of a disabled gunner. Figures IV,61 & IV,62 illustrate essential features of the redesign.

Summary. Thus, all four of the B-29 sighting stations were eventually modified to remedy defects warned against on anthropological grounds at an early stage, obvious when pointed out, sources of serious inefficiency in training and combat, yet easy to correct from a design standpoint at any time. After the original mistake had been made in ignoring the gunner, both by failing to specify detailed requirements for gunners' provisions in the Handbook and by neglecting to acquaint the airplane designer with the gunner's combat operations and equipment, production requirements precluded any effective remedy until nine to twelve months later, after needless loss in lives and



4136 - AML - H

Exhibit C
Figure 3.

FIG. 3. View of the A-10 Cockpit from the Pilot's Perspective. Page 10

Figure 3. 60

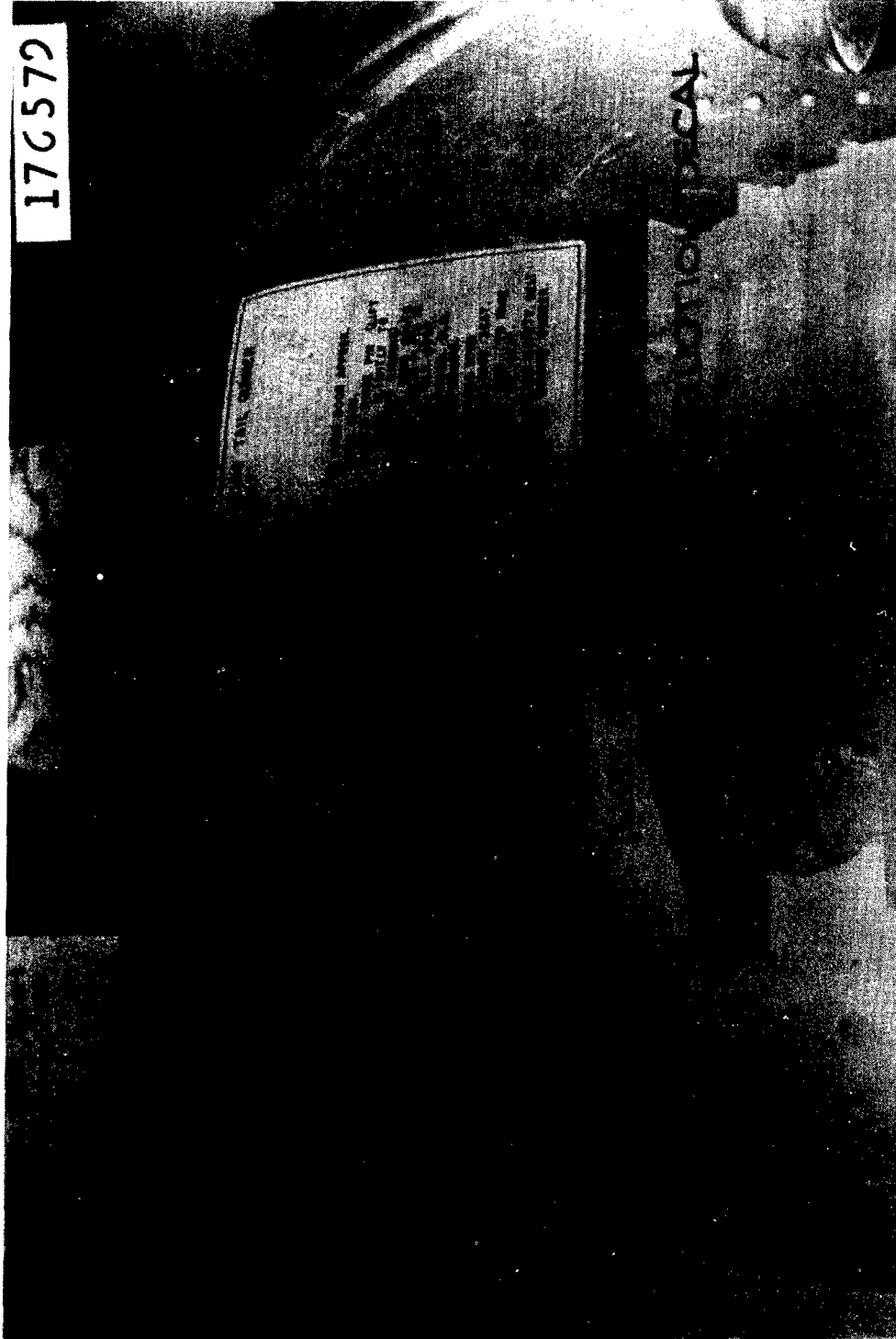

TG352 DEBAC CHG. NO 704M
VIEW OF BLK 1110 DOOR RENWORK FOR REMOVAL
OF TAIL GUNNER FROM COMPARTMENT

4136 - A-AML

Figure 21, 61

Mr. M. J. ...
...
...
...
...

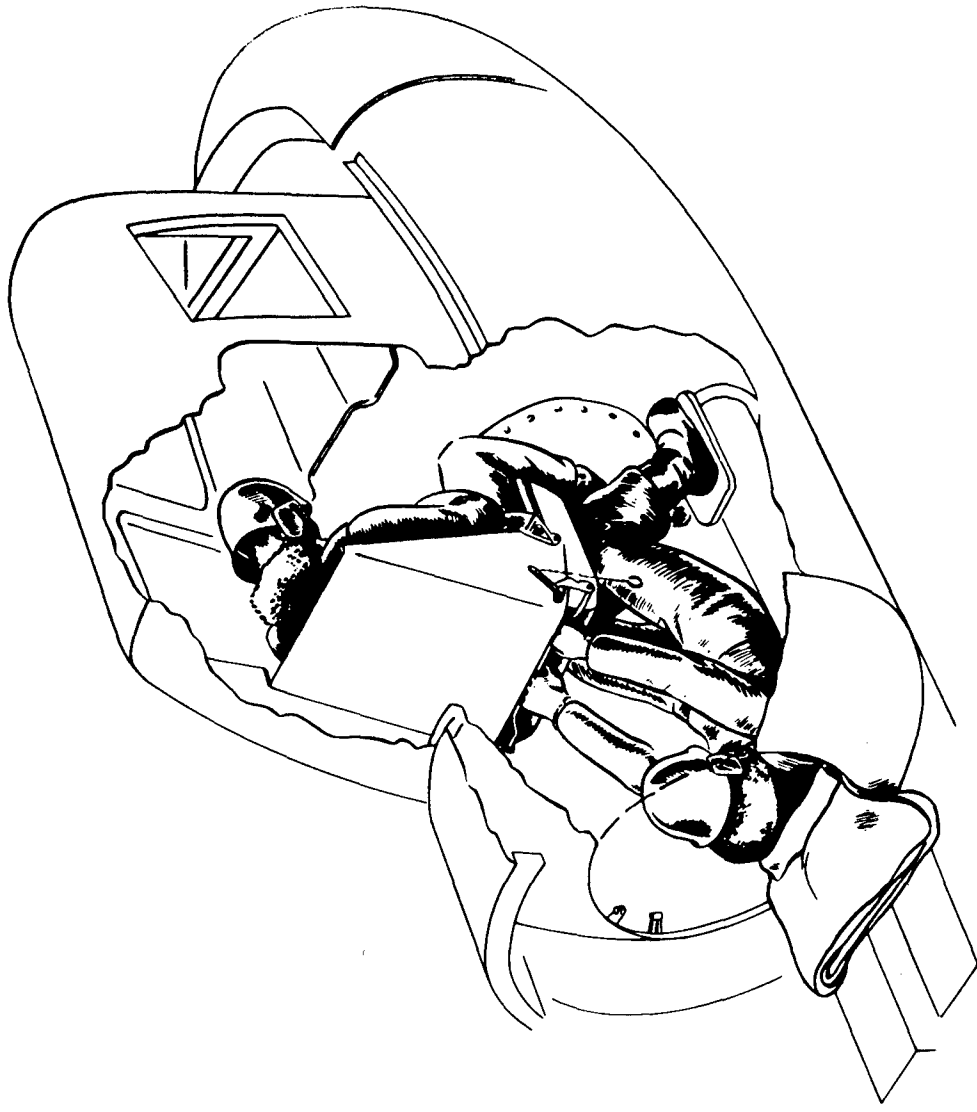

Tall Gunner Emergency Reaction

- 13 -

4137-D-AML

186.

Figure IV, 62

combat efficiency had been suffered. As occurred regularly in the case of local-control turrets, anthropological findings in the laboratory were substantiated by gunners' experience in the field. It is worthy of mention that the anthropometry of sighting stations, unlike that of local-control turrets, was rarely mensurational at all. General consideration of the flyer's welfare, amenable to rough-and-ready anthropometric approximation or to common sense alone, was sufficient in most instances without detailed analysis of human dimensions.

Theory of B-29 Sighting Station Deficiencies

A theory as to the reason for the troubled course of the B-29 sighting stations may be that, by a semantic confusion frequently encountered in human behavior, the engineers responsible for the development of central station fire control identified label with actuality; that is, since the armament was designated as "remotely" and not "locally" controlled, since the gunners were operating in so-called "sighting stations" inside the body of the airplane rather than in "turrets" or excrescences protruding from the airplane, no special attention need be paid the gunner. But the gunner in fact must still wear bulky gear and operate complex equipment in a restricted space. He must still be fitted into a functional arrangement providing for his comfort, efficiency, vision, and safety.

Conclusions

The principles which can be derived from the foregoing account of gunners' accommodations in B-29 remote-control turrets are precisely those which apply to local-control turrets. The term applied to the gunner's station-whether it is characterized as local-control turret, remote-control turret, sighting station, or gun position - is immaterial. For all,

(1) CONSIDER THE GUNNER. The prime requisite is awareness of the gunner as a vital factor in design, to be ignored only at great peril.

(2) CONSIDER HIM EARLY. It is as true for remote-control as for local-control turrets that the earlier the gunner and his gear are considered, the better will be his accommodations in the finished product. The modifications eventually installed in all four B-29 sighting stations were easy to effect at any time for an engineering standpoint, but once the design was crystallized, pressure for quantity production delayed their adoption for precious months. Even after the initial oversight had been made in not acquainting airplane and armament manufacturers with the gunner's problems, there was still time to rectify the design during the Mock-Up Inspection. There might even, in terms of the feared immediate production delay versus the production delay inevitable in any case when the modifications finally became mandatory plus the efficiency gained in the interim, have been time at the Engineering Acceptance ("689") Inspection.

(3) THE GUNNER IS FUNCTIONAL. The gunner who is thus to be kept in mind as much as a gunsight or a mechanical drive or an ammunition feed is a functional, dynamic entity, involving not only a variable range of static body dimensions and bulky combat gear, but a definite pattern of operations. The airplane or armament designer should strive to make the performance of these operations as easy and efficient as possible. The gunner's field of vision, especially in a scanning or sighting station, should be as large and unobstructed as possible. Whatever his duties, he must be kept comfortable, since fatigue reduces efficiency, and, if continued over a period of time, may render him unavailable for combat as surely as enemy action. And finally, provision should be made for his safety; his operating space should allow him to wear flak suit and parachute, to be accessible to other crew members, to have a good chance for emergency escape, and to be protected from the stresses of take-off, landing, crash landing, and ditching.

(4) FUNCTIONAL GUNNERS VARY IN SIZE.

(5) TEST GUNNERS' ACCOMMODATIONS WITH SUBJECTS REPRESENTATIVE OF AAF FLYERS.

(6) EVALUATE GUNNERS' ACCOMMODATIONS IN COMPLETE, FUNCTIONAL TURRETS. It cannot be too often repeated that complete combat equipment should be tried, on subject of different sizes, representing known percentiles of the AAF range, and in sighting stations complete with all their accessories - the latter in wooden facsimile, if not otherwise available. This was the procedure ultimately

followed in modifying the B-29 sighting stations; it is the test to which training and combat operations subject the sighting station or turret; and it should be standard practice from the very beginning on all turrets. If at all possible, gunners themselves, preferably with combat experience, should serve as advisors to Inspection Boards.

(7) PARTICULAR INSTALLATIONS, NOT OVERALL DIMENSIONS, CAUSE THE DIFFICULTIES. This principle of the local-control turret studies was amply confirmed by the B-29 sighting stations. Without increasing the dimensions of the B-29 or deleting any equipment, the troublesome features were remedied by rearrangement and revision of existing installations.

Finally, and most important of all, (8) ALL FLYERS REQUIRE ESSENTIALLY SIMILAR ACCOMMODATIONS. Turrets are but one type of crew station, and gunners but one type of aircrew. All flyers require adequate comfort, efficiency, vision, and safety; and all obtain them by essentially similar design accommodations for other bomber crew stations, passageways, escape hatches, and fighter cockpits are assessed by the same criteria as that of gunners' accommodations in turrets. Both aircraft designer and anthropologist can therefore apply the principles here presented, derived from the study of aircraft gun-turrets, to the design and evaluation of any aircraft space in or through which a man must operate.

Investigations Incidental to the Turret Study.

The turret study touched on a number of related topics, and a brief account of some of these side excursions will indicate the ramifications of any project involving the human factor in aircraft, as well as the central position of the anthropologist in integrating diverse items of equipment.

1. Questionnaires for combat gunners. Early in the War, when information on turret performance from the gunner's standpoint was needed, questionnaires were devised for several turrets, based on difficulties encountered in anthropometric inspections. Although the questionnaires were never widely distributed, those that were filled out by gunners in Alaska confirmed the anthropometric reports and were therefore valuable in convincing service and manufacturing agencies that such evaluations were more than laboratory speculation. Information obtained from using activities is vital to the successful development of any item, and the questionnaire is one method of obtaining such information.

2. Fatigue and performance tests in turrets. At an early stage of the anthropometric study of turrets, it was hoped that objective measurement and comparison of gunners' performance in different turrets might permit gunners' accommodations in those turrets to be ranked in order of excellence and might indicate the optimal arrangement of the gunner's working space. This hope proved naive in view of the complexity of fatigue research, and the project proved to be unnecessary in that even clear-cut results would have accomplished little or nothing more than the relatively crude anthropometric analyses.

Several subjects were actually tested, in three turrets (Sperry upper, Martin upper, and Briggs ball), by means of a beam of light projected erratically onto a screen, and picked up and scored by a photo-electric cell mounted between the two turret guns. (One attempt to measure flicker fusion frequency as an index fatigue of subjects just after operating turrets in flight failed signally because of uncontrollable elements in the test situation). It immediately became apparent that such familiar bugaboos of fatigue testing as training and variability of subjects, effect of learning, and standardization of test conditions could not be adequately controlled with the time and resources available. To take only one example, the test was set up in one corner of a large hangar, and at certain times of the morning the sun would shine directly into the gunner's eyes, completely nullifying the run. To equate the training of subjects (trained gunners not being available) and to reach a base line performance of each would have taken more time than the results seemed to warrant.

Quite apart from the testing difficulties, even clear-cut differences in performance could only indicate where to search for causes. Possibly relocation or redesign of one feature of a turret might alter its performance markedly, a possibility requiring considerable time to establish and leaving still undetermined the relative merits of fundamental turret layout. And it is unlikely that features of turrets which would make any considerable difference would escape notice in the routine anthropometric inspection. Thus, performance

tests could only supplement information obtained with infinitely less pains from other sources. And finally, basic turret arrangements (such as standing vs. sitting vs. kneeling vs. the ball turret position) were largely fixed by airplane design and dimensions, nor were choices between alternative turrets for a given position usually made on the basis of gunners' provisions. It was therefore decided that, although fatigue studies might be valuable over a long period, the immediate end of improving gunners' provisions in turrets could be better accomplished by other means.

3. Ball turret rescue tool. In May 1944, a former ball turret gunner in the 8th Air Force pointed out to the Aero Medical Laboratory a serious condition which had resulted in two deaths to his knowledge. A clutch release handle was provided by means of which crew members inside the airplane could rotate the turret so that the turret doors could be opened inside the plane and a disabled gunner rescued. However, when the turret was stopped at an angle of 80° - 85° below the horizontal, the handle could not reach the clutch shaft to disengage the turret, due to interference by the turret ring. In the two cases cited, one gunner had become anoxic and the other wounded when their turrets were at the inaccessible angle of depression, and they could not be reached. The informant had re-designed the tool to work at all turret positions.

The Aero Medical Laboratory verified this situation by testing several turrets, and brought it to the attention of the Armament Laboratory. The revised handle, with minor modifications, was immediately put into production.

4. Steel helmets for aircrew. This project is an interesting epitome of the entire AAF anthropometric undertaking. The high percentage of casualties due to head wounds from low-velocity fragments led, in 1943, to the requirement that all bombardment crews wear steel helmets. Brig. Gen. Malcolm C. Grow, then Surgeon of the 8th Air Force, designed a light steel helmet to stop such fragments, based on AAF Head Type V. At the same time, the Ordnance Department in this country modified the standard infantry helmet to fit over flying head-gear. The latter helmet afforded more protection than the former, but was larger, and the problem was whether one or two helmet types should be standardized.

Data on head size and turret clearances gathered during the anthropometric turret study showed that the Ordnance helmet (later the M-3) could not be worn in most turrets, whereas the Grow helmet (later the M-4) could, thus assisting in the decision to standardize two types. Other data, similarly gathered, were utilized (1) to determine procurement percentages of the two helmets; (2) in modifying the M-3 helmet, standardized for turret wear, to fit the entire range of head size in AAF flyers; and (3) in the design of a new, smaller helmet (later the M-5) by the Ordnance Department.

5. Parachutes for turret wear. Efforts by the Aero Medical Laboratory to co-ordinate turret and parachute design constitute another chapter in the integration of diverse equipment affecting the flyer. Despite the fact that parachute wear was mandatory, most turret gunners were for a long time unable to wear them. This fact was obvious from the earliest anthropometric inspec-

tions, and was amply confirmed later from other sources. Both turret and parachute designers were informed of the gravity of this problem, and progress was made along both lines.

In the Briggs ball turret, as mentioned above, the seat was lowered to allow a parachute to be worn. Chutes could also be worn in later versions of the Sperry upper and in the newer Motor Products and Emerson turrets.

As regards parachutes, experimental versions of thin back chutes (B-8) and seat chutes (Switlik 22 - and 24 - foot nylon and "rip-stop" models) were tested for suitability in turrets. Memorandum Report No. ENG-49-695-32I, dated 22 November 1943, subject: "Switlik 24-Foot Seat-Type Parachute - Suitability for Wear in Turrets" indicates the procedure. Recommendations such as to provide straps from catching on projections and pulling loose, were made and adopted. Eventually the Personal Equipment Laboratory took over the size testing in aircrew stations as well as the design of new types of parachutes, and developments toward the end of the War were promising.

Manikins

A fundamental aspect of good aircraft design should be a continuous treatment of the functional man as an item of equipment. To a designer, the aircraft will exist almost from the time he makes his first preliminary drawing. Consequently, it is vitally necessary to have true scale representation of the functional man for incorporation in all drawings he prepares. This should be common practice, regardless of the scale with which he is working. Also, the dynamic aspect of the man, his degree of movement, and his variation in size must be well known.

In order to aid designers in this respect, a profile manikin, jointed, and to 1/30th scale, Figure IV, 63, has been prepared, showing the man wearing heavy flying clothing. No personal equipment, such as parachute, life raft, emergency vests, and flak suits, is included, but dimensions are readily available and must be utilized in relation to the operational mission intended for the aircraft. The worst possible condition, that is, the most equipment ever to be required, must be provided for.

The man is represented in three sizes, called Types A, B, and C, in order to give a practical coverage of personnel expected to occupy crew positions. Type A, average, is 5 feet 9.4 inches tall in the nude, and weighs 154 pounds. Type B is short, 5 feet 5.5 inches, and weighs 140 pounds. Type C, 6 feet 1.5 inches and 172 pounds, is the tall man. Cockpits and other crew positions adequately accommodating this range of statures and weights will then be known to accommodate about 90% of flying personnel under current selection standards. Other dimensions are shown in Figure IV, 64.

The adjustabilities of seats and controls ~~previously described~~ will insure accommodation of 100% of flying personnel.

Clothing dimensions added to the nude values may quickly be obtained by reference to Figure IV, 46.

By use of photographic enlargement of the 1/30th scale profiles, any larger scale can easily be obtained.

Finally, for check purposes at the mock-up stage, full-scale, three dimensional manikins should be used to establish the degree of accommodation of the crew accommodations. Figures IV, 66, IV, 67, and IV, 68.

For reference use, manikins of female pilots, WASP's, were also prepared and are available. Figures IV, 69 and IV, 70.

For informational purposes, Figure IV, 71 shows manikin data as used by the German Air Force.

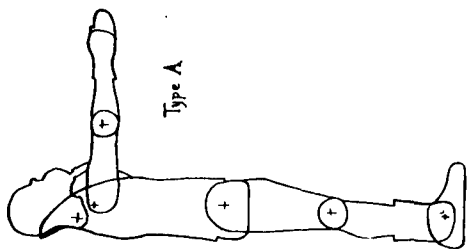
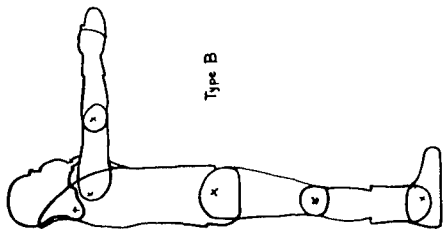
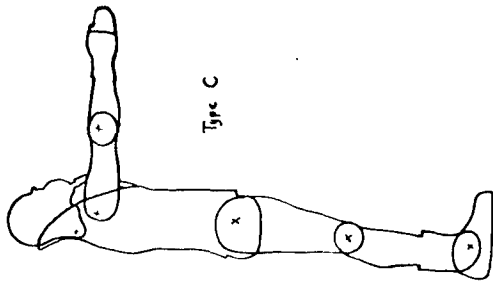

2932

Exhibit B.

Values and Distributions for Merikin Types.

	Type A	Type B	Type C
	Average	Average	Average
1. Weight	154.3 lbs.	140.3 lbs.	171.7 lbs.
2. Stature	175.3 cm.	166.5 cm.	186.3 cm.
3. Total Span	181.3 cm.	172.9 cm.	191.5 cm.
4. Anterior Arm Reach	88.9 cm.	85.0 cm.	93.8 cm.
5. Span Akimbo	93.9 cm.	82.5 cm.	99.7 cm.
6. Bi-acromial	39.3 cm.	38.0 cm.	40.6 cm.
7. Bi-deltoid	45.3 cm.	44.1 cm.	46.5 cm.
8. Chest Breadth	26.3 cm.	27.5 cm.	29.2 cm.
9. Chest Depth	20.3 cm.	19.8 cm.	21.0 cm.
10. Abdominal Depth	20.4 cm.	16-27 cm.	21.0 cm.
11. Bi-iliac	26.4 cm.	27.3 cm.	29.8 cm.
12. Head Circumference	56.4 cm.	55.8 cm.	57.0 cm.
13. Chest Circumference	90.7 cm.	88.6 cm.	93.2 cm.
14. Upper Arm Circumference	29.1 cm.	28.4 cm.	29.9 cm.
15. Forearm Circumference	24.2 cm.	23.7 cm.	24.8 cm.
16. Shoulder-fingertip	75.8 cm.	72.5 cm.	79.0 cm.
17. Forearm-fingertip	49.5 cm.	47.3 cm.	52.1 cm.
18. Hand Length	19.3 cm.	18.3 cm.	20.3 cm.
19. Hand Breadth	6.6 cm.	6.4 cm.	6.9 cm.
20. Wrist Breadth	4.1 cm.	4.0 cm.	4.3 cm.
21. Wrist Thickness	3.9 cm.	3.8 cm.	4.1 cm.
22. Scoulder-Elbow	23.0 cm.	22.5 cm.	23.6 cm.
23. Elbow-Seat	42.0 cm.	40.7 cm.	43.2 cm.
24. Bi-epicondylar Elbows	35.7 cm.	34.4 cm.	37.2 cm.
25. Bi-trochanteric	52.3 cm.	51.1 cm.	53.8 cm.
26. Thigh Circumference	35.5 cm.	34.7 cm.	36.5 cm.
27. Calf Circumference	125.0 cm.	118.7 cm.	132.8 cm.
28. Xiphoid Height	112.0 cm.	106.4 cm.	119.0 cm.
29. Lower Irb Height	104.8 cm.	99.9 cm.	111.4 cm.
30. Umbilicus Height	109.8 cm.	104.9 cm.	113.4 cm.
31. Iliac Crest Height	89.7 cm.	87.9 cm.	91.4 cm.
32. Pubic Height	82.2 cm.	81.0 cm.	84.6 cm.
33. Crotch Height	92.1 cm.	88.1 cm.	94.4 cm.
34. Sitting Height	59.3 cm.	57.5 cm.	62.8 cm.
35. Trunk Height	59.5 cm.	56.6 cm.	63.3 cm.
36. Buttock-Knee	55.3 cm.	52.3 cm.	59.2 cm.
37. Patella Height - Sitting	51.7 cm.	49.3 cm.	55.0 cm.
38. Patella Height - Standing	19.2 cm.	18.6 cm.	19.9 cm.
39. Knee Breadth	26.8 cm.	25.9 cm.	28.1 cm.
40. Foot Length	29.7 cm.	28.3 cm.	30.2 cm.
41. Foot Breadth	6.5 cm.	6.1 cm.	6.8 cm.
42. External Malleolus (Ankle) Height	6.7 cm.	6.3 cm.	7.0 cm.
43. Internal Malleolus (Ankle) Height	7.6 cm.	7.4 cm.	7.9 cm.
44. Ankle Breadth	9.6 cm.	9.3 cm.	10.0 cm.
45. Ankle Thickness	12.3 cm.	12.0 cm.	12.6 cm.
46. Mason-Wenton	84.5 cm.	81.8 cm.	88.2 cm.
47. Squatting Diagonal*			

*The subject sits on a six-inch block, as near the edge as comfortable, with the heels drawn up at the base of the block.
**Leans forward at the hips and clasps his hands at the knees. The dimension extends from the maximum curvature of the back near the shoulders to the tip of the longest toe.

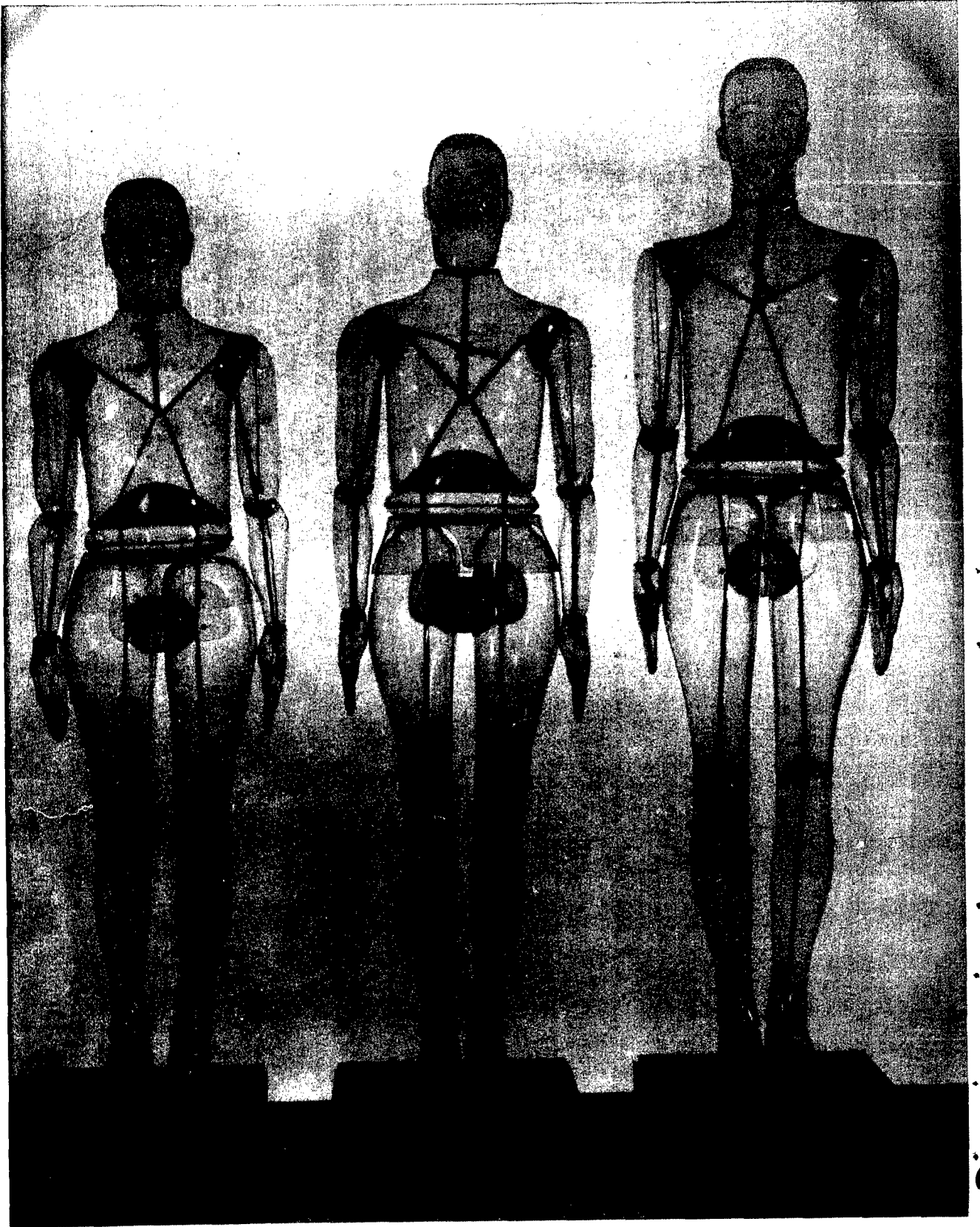

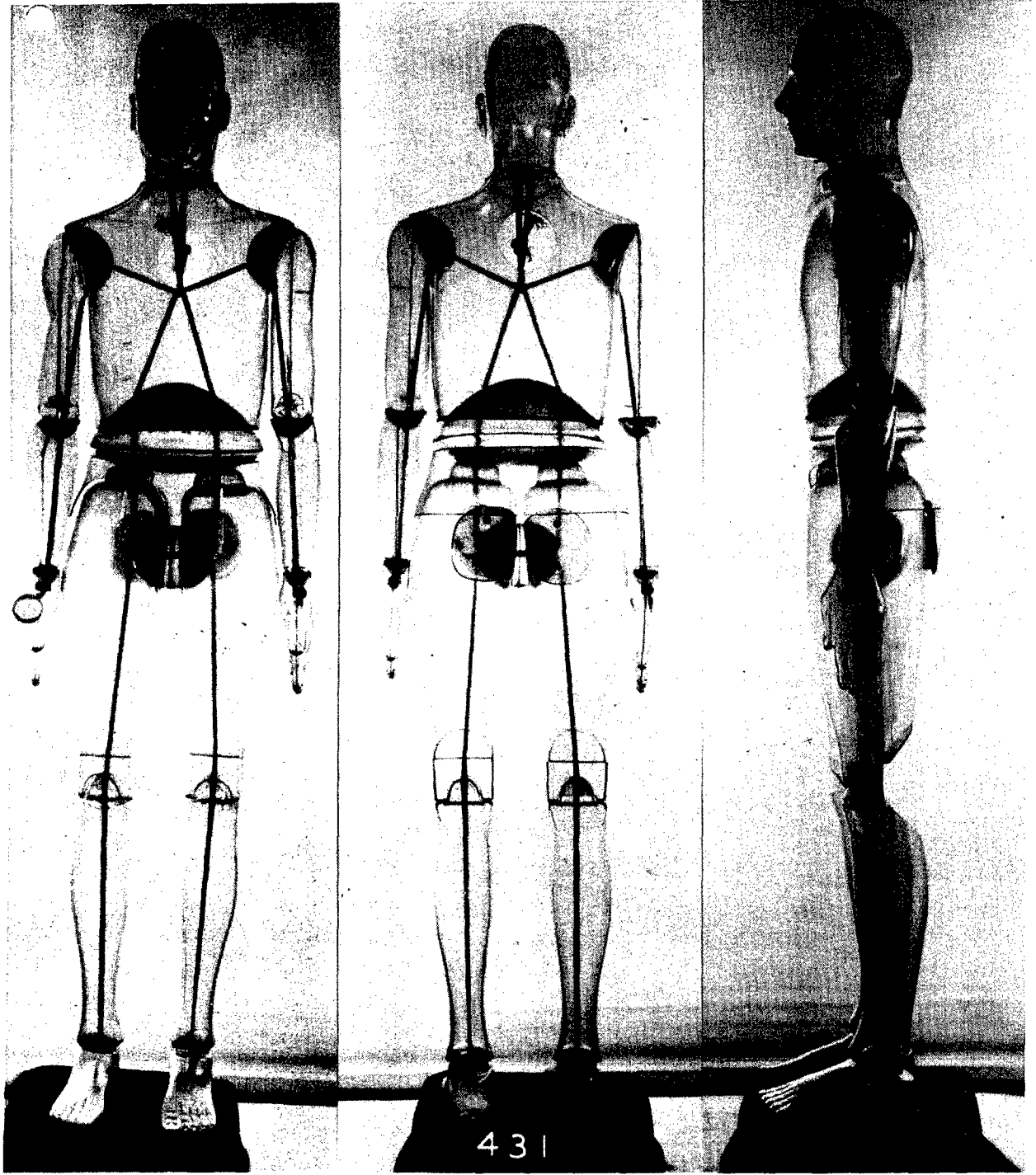

431

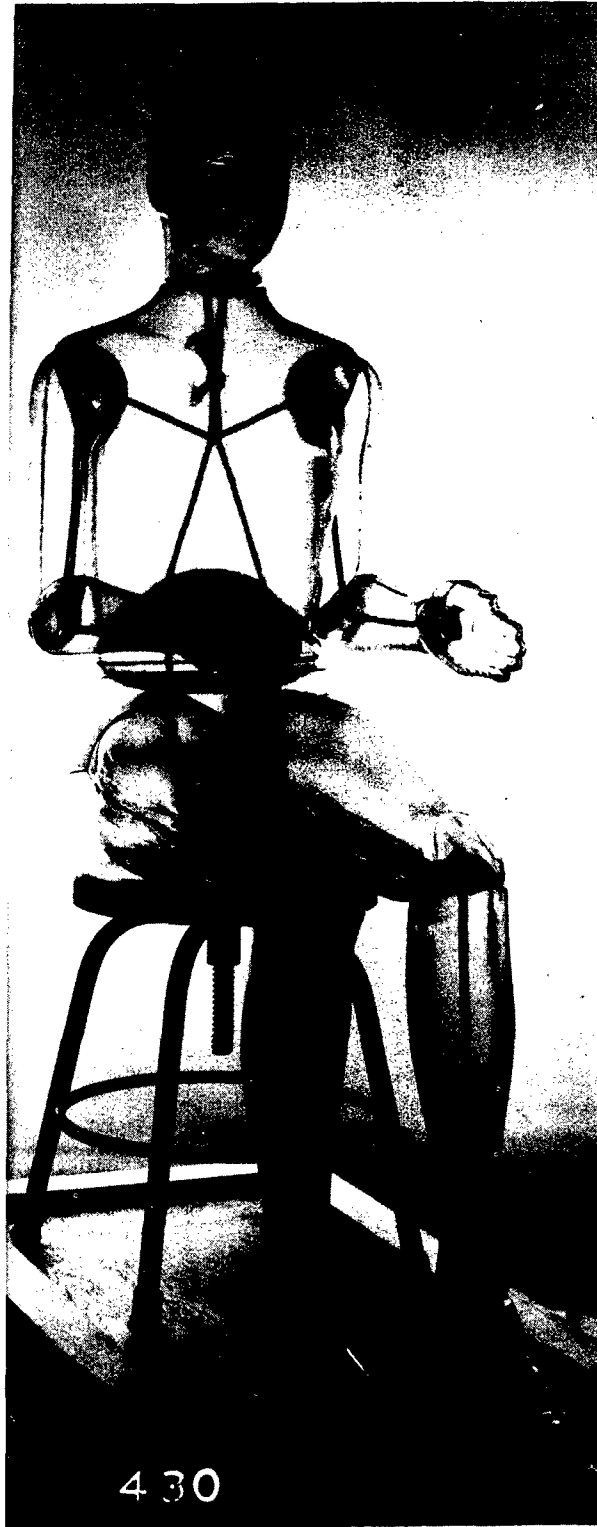
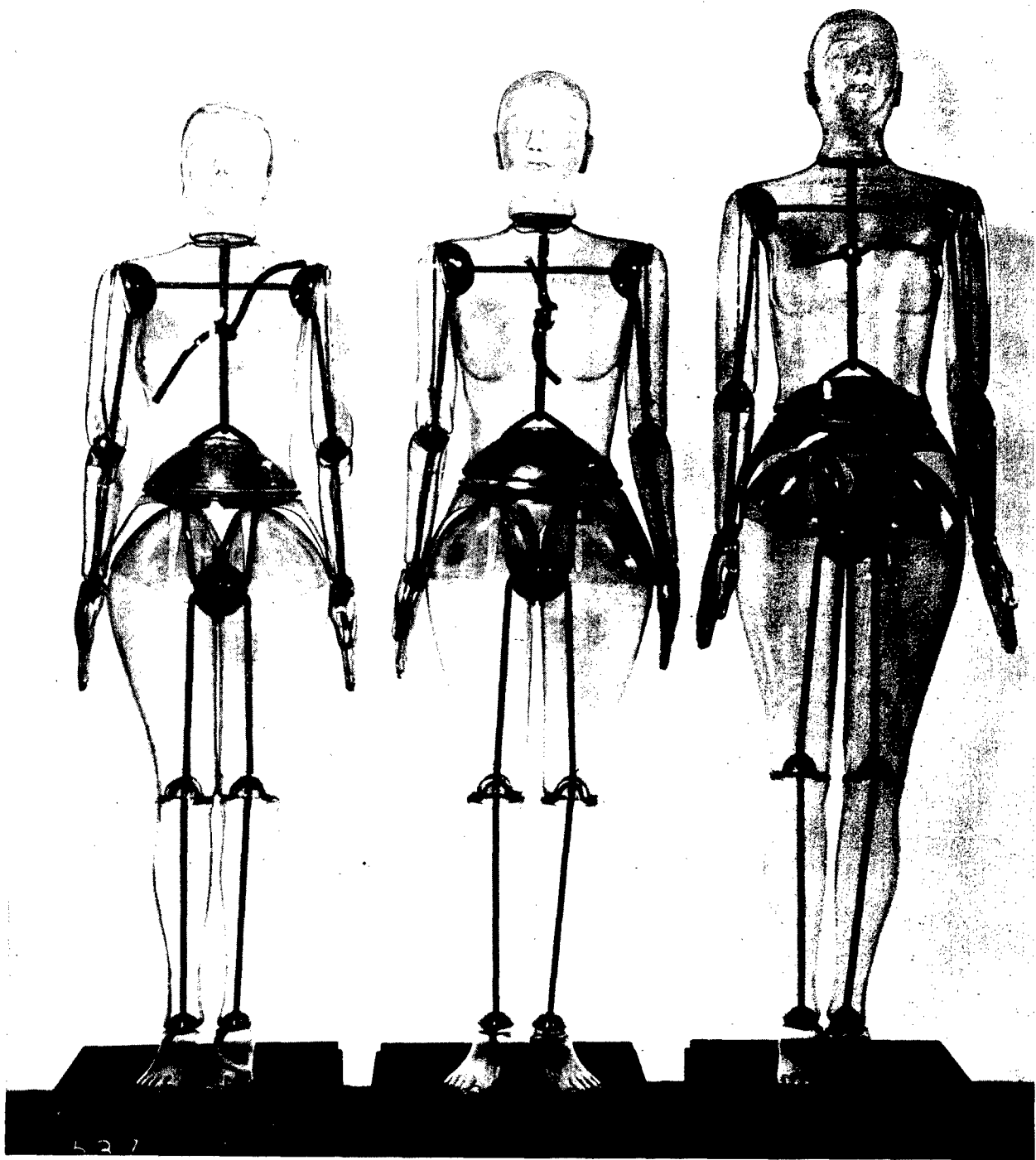

Figure IV, 67

FEMALE MANKIN

	TYPE A.		TYPE B.		TYPE C.		TYPE D.	
	Average		Average		Average		Average	
Weight	128.6 lbs.		159.0 cm.		175.2 cm.		121.9 lbs.	
Stature	161.8 cm.	64.9 in.	78.2 cm.	30.7 in.	85.2 cm.		161.3 cm.	63.5 in.
Anterior Arm Reach	80.7 cm.	31.8 in.	69.7 cm.	27.4 in.	77.4 cm.		79.1 cm.	31.1 in.
Arm Length	87.0 cm.	34.3 in.	83.9 cm.	33.0 in.	91.4 cm.		81.7 cm.	32.2 in.
Span-Akimo	34.7 cm.	13.7 in.	33.4 cm.	13.1 in.	37.0 cm.		36.4 cm.	14.3 in.
Shoulder-Elbow ht.	35.0 cm.	13.8 in.	34.3 cm.	13.5 in.	37.0 cm.		34.6 cm.	13.6 in.
Biacromial	10.9 cm.	4.3 in.	10.2 cm.	4.0 in.	11.2 cm.		10.4 cm.	4.1 in.
Midlaxoid	17.6 cm.	6.9 in.	17.0 cm.	6.7 in.	18.5 cm.		16.6 cm.	6.5 in.
Hand Length	7.7 cm.	3.0 in.	7.6 cm.	3.0 in.	8.0 cm.		7.3 cm.	2.9 in.
Wrist Breadth	7.7 cm.	3.0 in.	7.6 cm.	3.0 in.	8.0 cm.		7.3 cm.	2.9 in.
Upper Arm Circumference	24.9 cm.	9.8 in.	24.7 cm.	9.7 in.	25.3 cm.		24.4 cm.	9.6 in.
Forearm Circumference	19.0 cm.	7.5 in.	18.7 cm.	7.4 in.	19.7 cm.		19.2 cm.	7.6 in.
Wrist Breadth	5.4 cm.	2.1 in.	5.3 cm.	2.1 in.	5.5 cm.		5.2 cm.	2.1 in.
Wrist Depth	3.8 cm.	1.5 in.	3.7 cm.	1.5 in.	3.9 cm.		3.5 cm.	1.4 in.
Sitting Height	86.6 cm.	34.1 in.	84.2 cm.	33.1 in.	91.0 cm.		85.9 cm.	33.7 in.
Eye Height	76.1 cm.	30.0 in.	74.3 cm.	29.3 in.	80.1 cm.		74.4 cm.	29.3 in.
Shoulder Height	60.4 cm.	23.8 in.	58.8 cm.	23.1 in.	64.0 cm.		59.7 cm.	23.5 in.
Chest Breadth	25.8 cm.	10.2 in.	25.3 cm.	10.0 in.	27.0 cm.		26.0 cm.	10.3 in.
Chest Depth	19.0 cm.	7.5 in.	18.9 cm.	7.4 in.	19.1 cm.		18.5 cm.	7.3 in.
Neck Circumference	31.3 cm.	12.3 in.	30.7 cm.	12.1 in.	32.2 cm.		31.1 cm.	12.2 in.
Neck Circumference	88.8 cm.	35.0 in.	87.3 cm.	34.4 in.	90.9 cm.		88.8 cm.	35.0 in.
Chest Circumference	73.2 cm.	28.8 in.	72.4 cm.	28.5 in.	75.9 cm.		73.2 cm.	28.8 in.
Waist Breadth	22.5 cm.	8.9 in.	21.8 cm.	8.6 in.	23.2 cm.		22.2 cm.	8.8 in.
Waist Depth	20.9 cm.	8.2 in.	20.7 cm.	8.1 in.	21.3 cm.		20.6 cm.	8.1 in.
Hip Circumference	66.8 cm.	26.3 in.	65.8 cm.	25.9 in.	68.8 cm.		66.4 cm.	26.1 in.
Hip Circumference	98.8 cm.	38.1 in.	95.0 cm.	37.4 in.	99.1 cm.		98.4 cm.	38.7 in.
Mid-thigh	38.0 cm.	15.0 in.	37.6 cm.	14.8 in.	39.6 cm.		38.4 cm.	15.1 in.
Mid-thigh	39.2 cm.	15.4 in.	37.9 cm.	14.9 in.	40.2 cm.		39.9 cm.	15.7 in.
Elbow Breadth	102.9 cm.	40.5 in.	101.9 cm.	40.1 in.	104.9 cm.		103.9 cm.	41.3 in.
Crotch Height	77.3 cm.	30.4 in.	76.2 cm.	29.9 in.	78.5 cm.		77.9 cm.	30.7 in.
Buttock-Heel	57.5 cm.	22.7 in.	56.2 cm.	22.1 in.	58.5 cm.		57.5 cm.	22.7 in.
Patella Height	51.0 cm.	20.1 in.	50.3 cm.	19.8 in.	52.3 cm.		51.4 cm.	20.3 in.
Foot Length	21.3 cm.	8.4 in.	21.0 cm.	8.3 in.	21.7 cm.		21.3 cm.	8.4 in.
Foot Breadth	9.2 cm.	3.6 in.	9.1 cm.	3.6 in.	9.4 cm.		9.1 cm.	3.6 in.
Ankle Breadth	6.5 cm.	2.6 in.	6.3 cm.	2.5 in.	6.6 cm.		6.4 cm.	2.5 in.
Ankle Depth	8.1 cm.	3.2 in.	7.9 cm.	3.1 in.	8.3 cm.		8.0 cm.	3.1 in.
Knee Breadth	19.2 cm.	7.6 in.	19.0 cm.	7.5 in.	19.7 cm.		19.1 cm.	7.5 in.
Thigh Circumference	19.4 cm.	7.7 in.	19.2 cm.	7.6 in.	19.8 cm.		19.4 cm.	7.7 in.
Calf Circumference	35.0 cm.	13.8 in.	34.5 cm.	13.6 in.	36.0 cm.		35.2 cm.	13.9 in.
Head Length	18.7 cm.	7.3 in.	18.5 cm.	7.3 in.	19.0 cm.		18.6 cm.	7.3 in.
Head Breadth	11.7 cm.	4.6 in.	11.6 cm.	4.6 in.	12.0 cm.		11.7 cm.	4.6 in.
Head Circumference	55.2 cm.	21.7 in.	54.7 cm.	21.5 in.	56.9 cm.		55.9 cm.	22.0 in.
Face Length	11.6 cm.	4.6 in.	11.3 cm.	4.5 in.	11.8 cm.		11.6 cm.	4.6 in.
Face Breadth	5.2 cm.	2.1 in.	5.1 cm.	2.0 in.	5.3 cm.		5.1 cm.	2.0 in.
Nose Length	5.3 cm.	2.1 in.	5.2 cm.	2.1 in.	5.5 cm.		5.2 cm.	2.1 in.
Ear-Lar	10.7 cm.	4.2 in.	10.6 cm.	4.2 in.	10.9 cm.		10.7 cm.	4.2 in.
Masal Bridge Salient	2.6 cm.	1.0 in.	2.6 cm.	1.0 in.	2.6 cm.		2.6 cm.	1.0 in.
Masal Bridge Breadth	3.1 cm.	1.2 in.	3.1 cm.	1.2 in.	3.1 cm.		3.1 cm.	1.2 in.

Figure IV, 68



GERMAN AIR FORCE MANIKIN

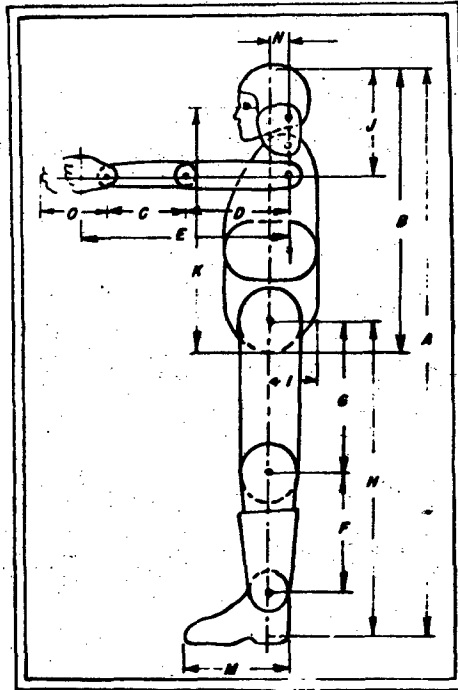

Body Size	Length Measurements in Inches													
A	b	c	d	e	f	g	h	i	k	l	m	n	o	
65.0	33.4	9.1	11.9	24.4	13.8	17.1	33.4	5.5	29.2	11.8	11.8	2.0	7.9	
68.9	35.4	10.0	13.2	27.0	15.3	18.7	37.4	5.9	30.9	13.0	12.8	2.4	8.7	
74.9	38.4	11.0	14.6	29.5	16.9	20.2	41.4	6.3	33.8	14.1	13.8	2.8	9.4	

BREADTH AND DEPTH DIMENSIONS (Total Dimensions with Winter Clothing)

Trunk	Arm breadth, measured from elbow to elbow, arms at sides, arm flexed.	23.6
	Sitting breadth (sitting).	15.7
	Chest depth (3) (sitting).	11.8
	Abdominal depth (sitting).	11.8
Hand	Hand breadth, measured across knuckle, without thumb.	3.9
	Hand thickness.	1.8
	Index finger thickness.	1.0
Leg	Thigh breadth (measured in middle, sitting).	7.9
	Thigh thickness (measured in middle, sitting).	7.1
	Knee breadth (flexed).	5.9
Foot	Boot breadth.	5.1
	Boot thickness, measured at basal phalanx of 1st toe.	3.1

- 1) Given as the dimension of the winter glove.
- 2) Given as the dimension with felt over boot.
- 3) Without oxygen equipment and back-type parachute.
- 4) Breadth and thickness rounded off to higher value; they are therefore approximations without exactness.

4404A AML

Figure IV, 70.

CHAPTER V

Emergency Exits

To an aircraft designer an emergency exit is somewhat of an unnecessary evil, inasmuch as it is to a great extent a passive addition to the airplane and will inhibit the full strength fulfillments of the structures. Any aperture which must be left in the skin of the airplane will result in some loss of stressing. However, there are certain safety conditions so far as the crew is concerned which must be fulfilled in order to gain in the long run the full operational measures. The old theory that a man who gets away and lives to fight another day is still a good man is one which still is as important as it ever was. The operational record of escaped aircrew members who have re-entered combat has been remarkable, and is proof in itself that good emergency exits are important features in all combat planes. Therefore, it is felt that a good deal of study can be made on the functional qualities of emergency exits and objective methods derived for instituting the necessary compromises between the actual size of the opening required, the factors involved, and the strengths of structures of the plane. A considerable amount of work has been done by the indirect method of interviewing crew members who have successfully bailed out of aircraft or who have successfully survived ditching of planes. Most of these records contain in them certain points which emphasize the importance of exits which are adequate in size and in performance. A very high percentage of reports has indicated that time and time again the mechanism involved in jettisoning the door has failed, and that this has resulted in loss of lives. Unfortunately, all of these data are derived from men who have survived bail-out and who must serve as circumstantial evidence to indicate that some of their fellow crewmen failed completely to escape from the aircraft. Many other comments have related the fact that men actually had to be pushed and pried through openings which were obviously too small.

The methods by which objective data can be obtained regarding the essential size requirement of emergency exits are relatively simple in the first stages. One method is by construction of mock-ups of various sizes, shapes, and positions. By the simple process of having men actually pass through these apertures with the maximum amount of personal equipment and body size actually encountered under operational conditions, we may learn much about the requirements. Experiments have been conducted in this manner, and have indicated that minimum sizes can be established without regard to the various other complicated factors, such as slipstreams, adjacent projections from the aircraft, and the cramped quarters which are commonly encountered inside the airplane. This method in itself is quite incomplete, but it has served to establish the fact that there are, at the present time, apertures in aircraft through which it is well nigh impossible to pass, under the most ideal conditions. This, in itself, should be conclusive proof that the emergency exits should be made not smaller than the following sizes:

Openings located in the side of an aircraft should not be less than 31" in a vertical dimension, and 20" in the horizontal dimension. An opening located in the bottom of the plane should not be less than 29" in the fore-and-aft

dimension, and 20" in the lateral dimension. Openings designed for bail-out procedures should never be located in the upper half of the airplane. Every attempt to do this has resulted in increased hazards on the part of crew members during aircraft failure in flight, because of the high incidence of impact with wing and/or tail structures. Some installations have gone so far as to require that the man must bail-out into the area of the propellor and have been installed on the assumption that the engine could be stopped and the propellor feathered. Installations of exits in the upper half of the aircraft should be confined entirely to the requirement of ditching and crash landing escape. The minimum dimensions for these openings under the most ideal conditions are 18" diameter or 18" square. In every case access to the openings must be readily available by means of steps or otherwise. (Figure V, 1).

One of the most encouraging features which has been considered for emergency exit openings has been the design and installation of the other items of equipment which must project through the skin of the aircraft in such a manner as to be jettisonable. This would apply to gun turrets, radar installations, and photographic equipment, many of which require openings which are at least adequate in size so far as bail-out or ditching requirements are concerned. Astrodomes, in particular, if properly designed and installed, can easily be used for ditching requirements and are particularly advantageous because they are frequently available to a large proportion of the crew.

A considerable number of other factors which are not directly designed as emergency exits is still worth consideration, inasmuch as they effect the functions of the exits. For example, an exit of more than adequate size is still completely worthless if the crew members are prohibited from reaching it by the random installation of other pieces of equipment along the pathway a man must use in proceeding from his crew position to the exit. Furthermore, even on the assumption of well planned internal installation of equipment, many seemingly minor factors may still enter into the eventual problem. Admittedly, in a construction process of many of the pieces of equipment, the fact that small bolts may project 1/2" beyond their required distances appears to be a very small space consideration, but this half inch may determine whether or not a man under emergency conditions will reach his exit because under hurried conditions the snagging of clothing, of parachute harnesses, or even of the ripcord handle, may hamper progress of the man to such an extent that he never succeeds in reaching the hatch in time. In the installation of the opening, these small projections are multiplied tremendously in their importance to the proper achievement of bailout.

Another consideration which should be kept in mind in bail-out procedure, from the design standpoint, is a common-sense realization that a man cannot clear large vertical distances without the help of handholds or footholds. These factors are readily analyzed in the early mock-up stages of any airplane and a little foresight on the part of the designer, the construction men, and the military authorities would do much in preventing the future loss of lives. One of the most important considerations from the standpoint of necessary handholds and footholds should be that involved in the part played by acceleration forces during bail-out procedures. It seems hard to realize at first that it is impossible for a man to raise himself out of a seat when as little as three "G"'s are being applied to him, but this is an actual fact. The further instal-

**MINIMAL SIZES AND OPTIMAL SHAPES
FOR ESCAPE HATCHES**

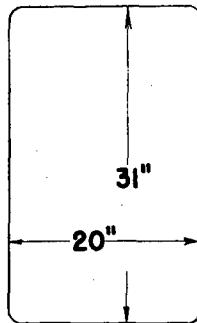

SIDE HATCH

**FULL EQUIPMENT INCLUDES—FLYING CLOTHES, EMERGENCY (C-1) VEST, LIFE VEST,
AND CHEST, BACK OR SEAT-TYPE PARACHUTES.**

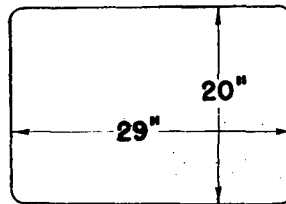

BELLY HATCH

**FULL EQUIPMENT INCLUDES—FLYING CLOTHES, EMERGENCY (C-1) VEST, LIFE VEST
AND CHEST, BACK OR SEAT-TYPE PARACHUTE.**

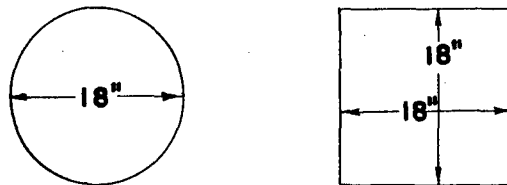

TOP DITCHING HATCHES

**FULL EQUIPMENT INCLUDES—FLYING CLOTHES, EMERGENCY (C-1) VEST, LIFE VEST
AND DINGHY.**

AERO MEDICAL LAB.

3456

Figure V, 1.

lation of recessed handholds will aid the man in being able to extricate himself from such awkward situations.

Further consideration along this line should be a full realization that there are certain requirements for proper storage space of miscellaneous loose equipment. An item which weighs no more than twenty pounds is extremely difficult to handle under the influence of three "G"'s, or even less, because the movements of the man himself have become extremely limited, and it can readily be imagined what difficulties a man would have in trying to displace odd objects along his path of egress.

It has been the experience of the Army Air Forces, during the past years, that the application of common sense to the analysis of these problems will solve most, if not all, of them.

CATWALKS

Catwalks are passageways installed in heavy aircraft to permit and to facilitate movement of personnel throughout the airplane. With an intent to facilitate movement, it is highly desirable that the structures be so placed that the personnel may move about with the least possible restriction. This holds especially for men who are wearing heavy equipment, including a parachute.

There are two dimensional requirements which must be met; first, for maximum structural strength it must be trapezoidal in shape; and secondly, it must be large enough in cross-section to permit the easy transgress of any person wearing full flying equipment and falling into the size range of Air Corps Flying personnel.

Experimental tests conducted by means of mock-up, Figure V, 2, have indicated that minimum dimensions for such a trapezoid are sixty-three inches in height, twenty-two inches on the top side, and twelve inches at the bottom.

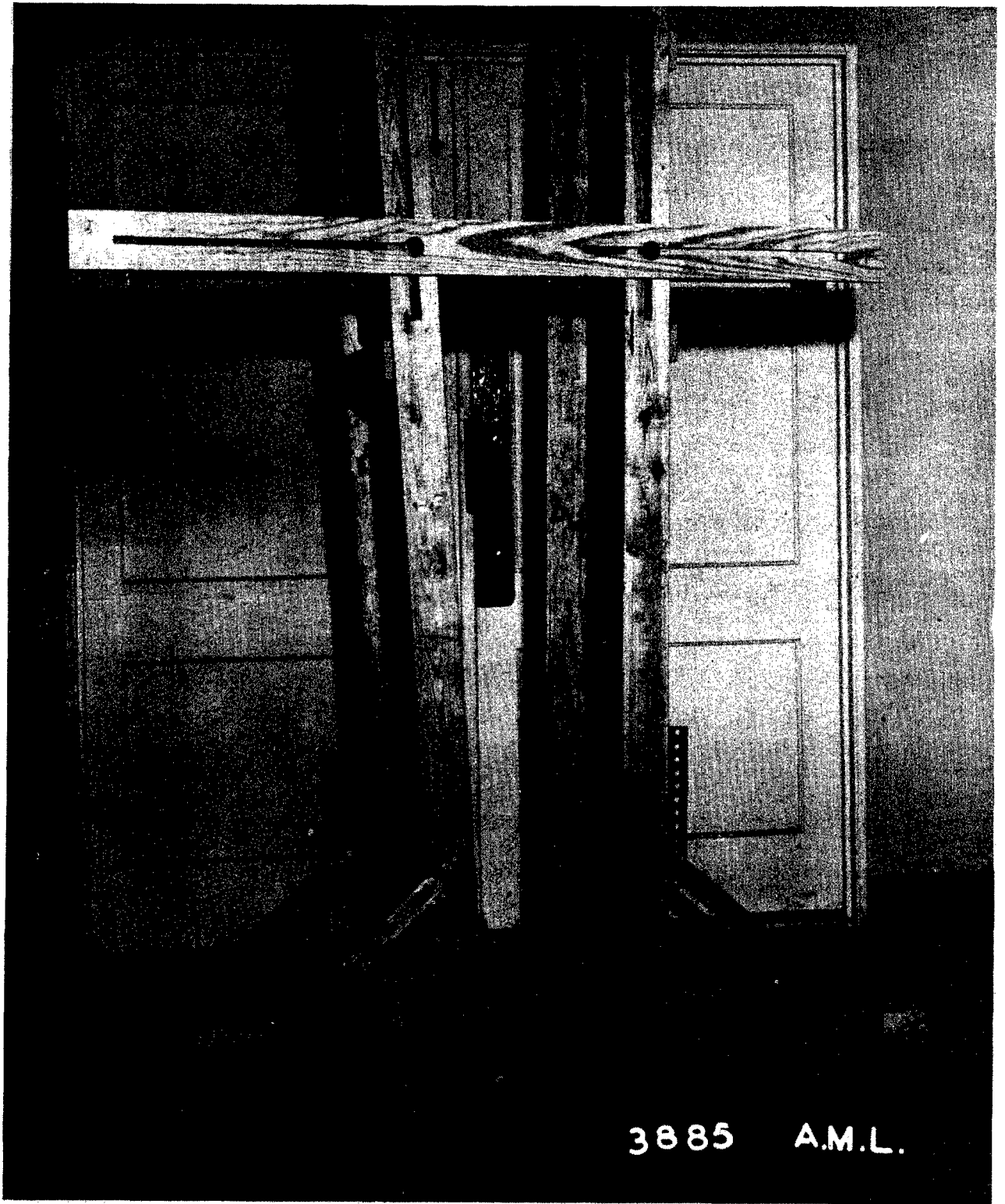

3885 A.M.L.

CHAPTER VI

Crew Weights

In Chapter II, The Functional Man, there was a discussion of the factors involved in the increase in size due to the addition of personal equipment, and to required motions of the body. In addition, there is another factor related to the man and his equipment which is important in the consideration of weights and balances in aircraft. This is the increase in weight due to the addition of equipment.

Nude body weights in aircrew are ordinarily limited as follows:

- a. Fighter pilots, 120 to 180 pounds.
- b. Commissioned bombardment aircrew, 120 to 200 pounds.
- c. Gunners, 120 to 170 pounds.
- d. Other non-commissioned aircrew, 120 to 200 pounds.

The common practice in listing of crew weights has been to give 200 pounds total, based originally on a top of 180 pounds nude, plus 20 pounds of parachute. Personal equipment became so complex during the war that the following weights were possible for different crew positions, due to equipment alone.

- a. Low altitude fighter, 71 pounds, 4 ounces.
- b. High altitude fighter, 82 pounds, 9 ounces.
- c. Medium and heavy bombardment, 117 pounds, 6 ounces.
- d. Very Heavy bombardment, 108 pounds, 15 ounces.

It should be apparent from these figures that much closer attention should be paid to total crew weights in the operational aircraft. The design purpose of the aircraft should be clearly defined and the individual crew weights possible for the various positions calculated on that basis, rather than using a rounded value of 200 pounds.

Subsequent to the above calculations, the AAF issued instructions that bomber crews would be figured at 250 pounds, exclusive of flak suits and one-man life rafts, and fighter, at 230 pounds.

A breakdown of the personal equipment weights for the various types of aircraft is as follows:

	<u>Heavy Bombardment</u>	
	lbs.	oz.
1. Electric suit: For high altitude temperature below 0°F. Heavy underwear, G. I. uniform, F-3 suit, B-15, A-11 suit, heavy socks, electric insert, A-6 boot, F-2 glove, AN-H-16 shearling helmet, belt, suspenders, connecting cord, bail- out bottle H-2, and oxygen mask.	29	6
2. For pilot, co-pilot, all fighter personnel; (on seat): B-8 parachute, B-5 cushion, C-1 emergency vest.	36	

	lbs.	oz.
3. For all flight personnel over water: B-4 life vest, 1-man raft.	21	12
4. Belt, holster, pistol, clip, 7 rounds.	3	15
5. Flak, helmet and suit.	26	6
	117	33

Very Heavy Bombardment

1. <u>Intermediate Suit</u> : For moderate altitude or heated cabins: temperature 14° to 50°F. Cotton underwear, G. I. uniform, B-15, A-11 suit, light wool sock, service shoes, A-6 boot, A-11A glove, A-11A helmet, suspenders, belt, oxygen mask, H-2 bailout bottle, electric goggles.	20	14
2. For pilot, co-pilot, all fighter personnel: (on seat): B-8 parachute, B-5 cushion, C-1 emergency vest.	36	
3. For all flight personnel over water: B-4 life vest, 1-man raft.	21	12
4. Belt, holster, pistol, clip, 7 rounds.	3	15
5. Flak, helmet and suit.	26	6
	106	47

Low Altitude Fighter

1. <u>Light suit</u> : for low altitudes, heated cabins, temperature 50° to 86°F. Cotton underwear, G. I. wool uniform, AN-S-31 gabardine coverall, cushion sole socks, service shoe, B-3A glove, AN-H-15 helmet, belt.	9	9
2. For fighter personnel: (on seat): B-8 parachute, B-5 cushion, C-1 emergency vest.	36	
3. For all flight personnel over water: B-4 life vest, 1-man raft.	21	12
4. Belt, Holster, pistol, clip, 7 rounds.	3	15
	71	41

High Altitude Fighter

1. <u>Intermediate suit</u> : for temperature 14° to 50°F. Cotton underwear, G. I. uniform, B-15, A-11 suit, light wool sock, service shoes, A-6 boot, A-11A glove, A-11A helmet, suspenders, belt, oxygen mask, H-2 bailout bottle, electric goggles.	20	14
2. For fighter personnel: (on seat): B-8 parachute, B-5 cushion, C-1 emergency vest.	36	
3. For all flight personnel over water: B-4 life vest, 1-man raft.	21	12
4. Belt, holster, pistol, clip, 7 rounds.	3	15
	80	41

The average nude crew weight is about 154 pounds and could be used as a generalization for rounding off weights, but should not be used as a fixed figure, regardless of crews, inasmuch as the individual crew will not be loaded as average weights all the time. "An aircraft does not fly on the average!"

CHAPTER VII

Movement of the Head and Eye in Sighting

Tests were made to determine the arc of movement of the head in following with the eyes a series of points at various angles above and below the horizontal, extending from directly above to directly below the subject. No turning to the side was involved. The total arc covered by the series of points is 180° , and nine fixation objects were used, at $22\frac{1}{2}^\circ$ intervals, as shown in figure VII, 1.

The subject was instructed to look at the various points in succession, at each stage holding his head in whatever way seemed most comfortable and natural. A record was made of the position of the eye and of the ear-hole at each stage. There is some erratic variation due to individual preference in moving the head more and the eyes less, and vice versa, to obtain a given angle of vision, but all subjects followed the same general pattern. The diagram in Figure VII, 2 represents the average of twenty-one subjects.

Adjustment for looking at points near the horizontal plane and up to about 45° above is made largely by movement of the head on the neck. Movement of the entire neck becomes more conspicuous as the latitude of the movement increases. The subjects are not allowed to bend the trunk forward, though there is an inclination to do this in looking down.

The requirements for an adequate sight mounting are that the sight shall move and turn in such a way that the axis of the sight shall always be aligned with the position which the eye normally occupies when looking in the direction in which the sight is aimed. When the guns are aimed 45° upward from the horizontal, for instance, the eye in its normal position for looking up at 45° should be in the correct position for holding the target in the center of the sight. In addition, the distance between sight and eye should remain fairly constant.

The head movement cannot be fitted into any simple geometric formula, so that some deviations from the experimentally determined angles of sight and eye positions will be necessary in order to fit a mechanical system of sight movement to the normal system of head and eye movement. It is important that any deviations shall be made in the right direction.

In stage 1 of Figure VII, 2 (looking directly upward), head, neck and eye movement are all very nearly at maximum, and no liberties should be taken with the position of the sight. The worst possible error is to have the sight too far forward at the time when it is aimed directly upward; this necessitates tipping back of the head while the neck is held straight. Since many of the neck muscles extend all the way from the back of the head down to shoulder level, and act on the head and neck simultaneously, this is a very difficult position to maintain.

In stages 2, 3, and 4 (from 67° to 22° upward), the sight movement will

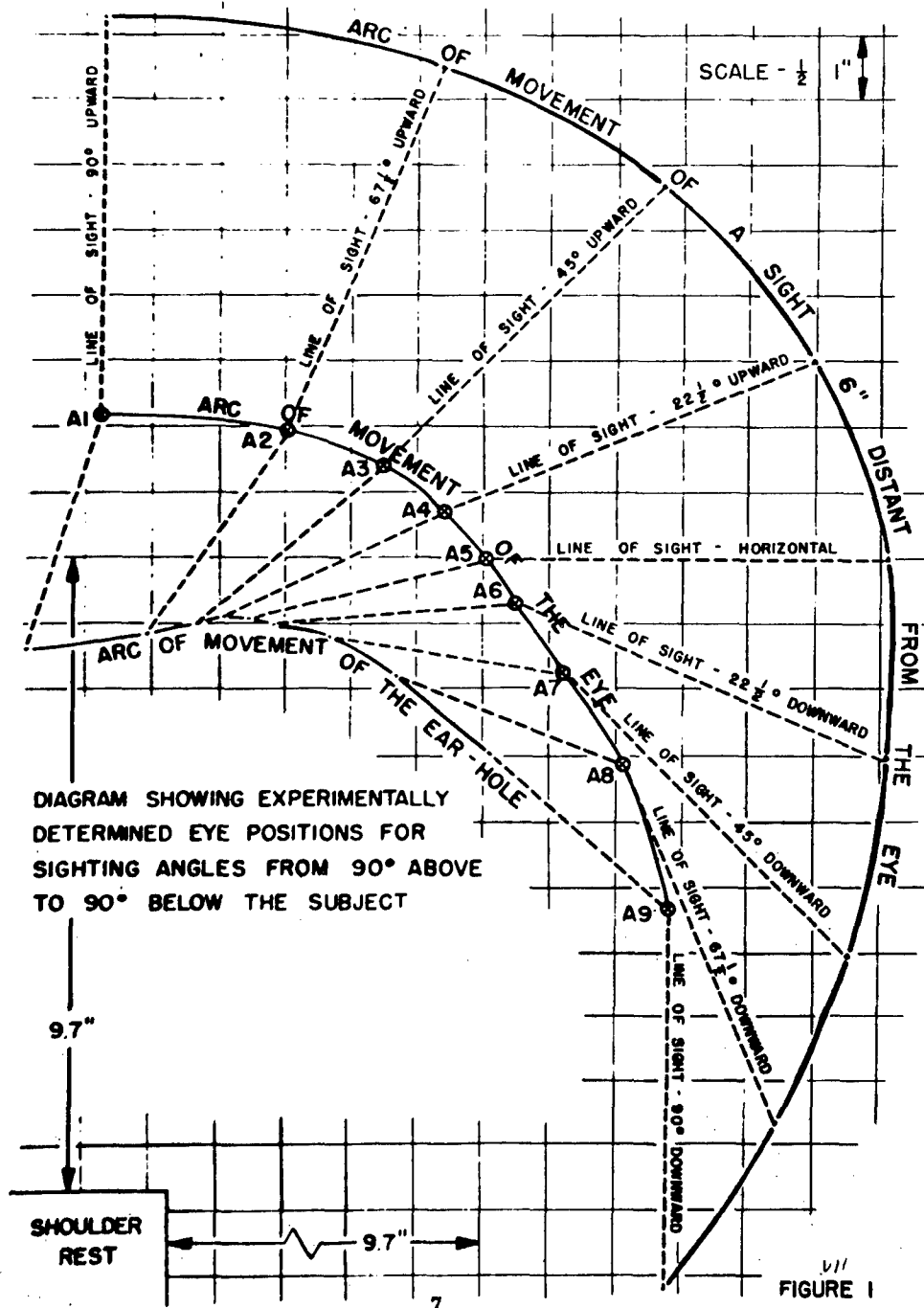

DIAGRAM SHOWING EXPERIMENTALLY DETERMINED EYE POSITIONS FOR SIGHTING ANGLES FROM 90° ABOVE TO 90° BELOW THE SUBJECT

VII
FIGURE I
Figure VII, 1

4533A-A M L

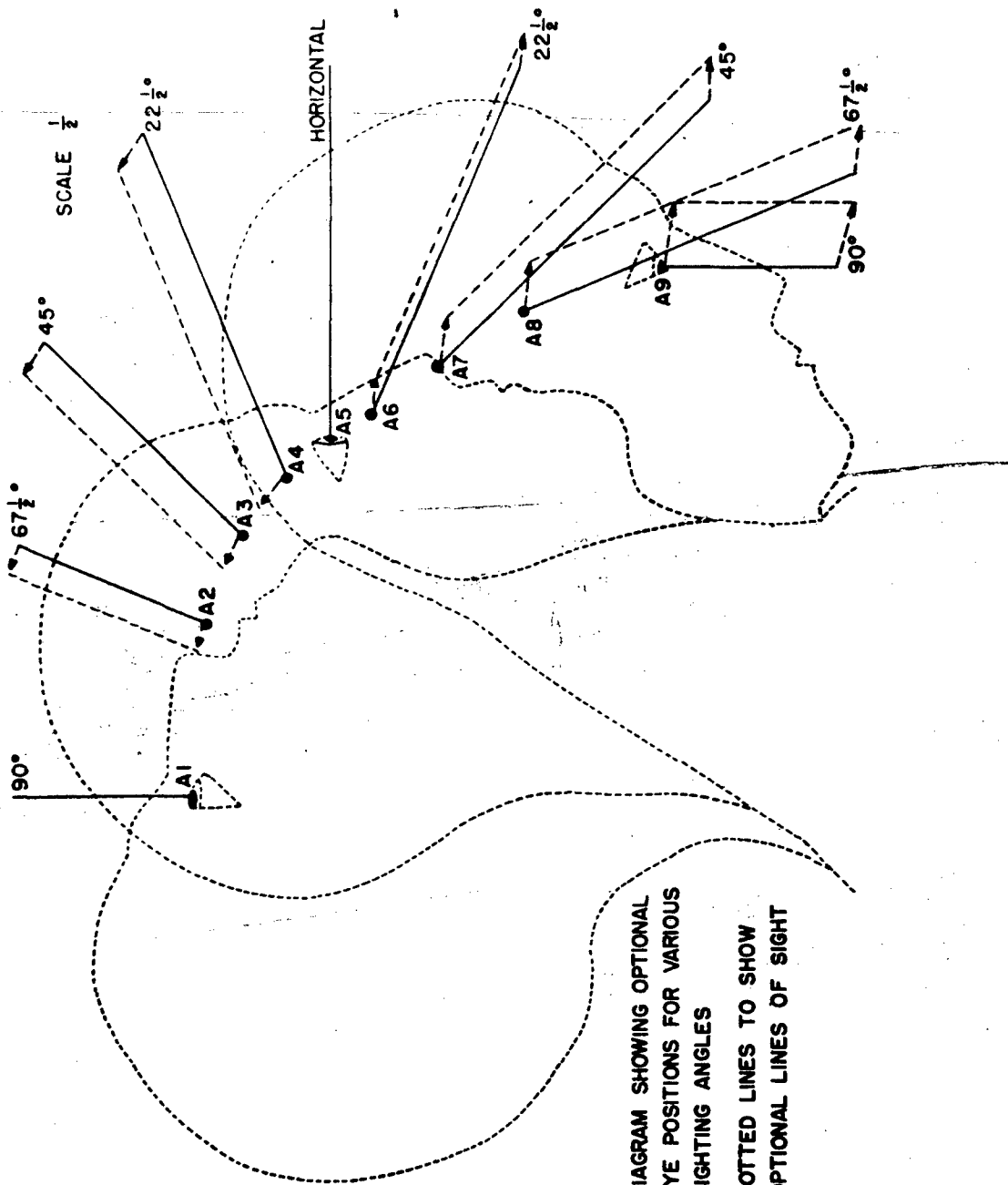

DIAGRAM SHOWING OPTIONAL
 EYE POSITIONS FOR VARIOUS
 SIGHTING ANGLES
 DOTTED LINES TO SHOW
 OPTIONAL LINES OF SIGHT

4533B-A M L

FIGURE 2

Figure VII, 2

give fair satisfaction if the line of sight passes from one-half to one inch back of the eye points A2, A3, and A4. Accommodation can be made by increasing the angle of the head and decreasing the angle of the eye.

The horizontal (stage 5) is taken as point of reference. Adjustment to this must be made by adjustment of the seat; the sight positions for other stages should be correct when the position for stage five is correct.

In stages 7, 8, and 9, particularly the latter, the sight action may be as if points A7, A8 and A9 were one-half to one inch further forward, since bending of the trunk, not allowed in the experimental arrangement, may be brought into play. The subjects showed an inclination at stage 9 to lean away from the shoulder rest, although in a moving airplane they would sacrifice some stability by doing so.

The distance between sight and eye can be varied if necessary in order to satisfy the other conditions better. The distance of the sight is less critical than the proper position of the sight at various sighting angles.

The movement and rotation of the sight cannot be reduced to any system with a single axis of rotation. A compound system can be devised, however, by which the sight will travel in an arc which keeps it at a constant distance from the eye and at the same time facing in the correct direction at each point of its arc; making use where necessary of the possible compromises outlined above. One such system is illustrated in Figure VII, 3 to give an approximate fit for a sight moving through an arc of 180°. If a range of less than this angle were to be used, other systems could be devised to give an even better fit over a smaller range of angular motion.

It should be noted that when looking directly upward, the average subject tips his head back until the back of the head is two and one-fourth inches behind the plane of the back-rest. An additional inch should be allowed for larger heads.

DIAGRAM ILLUSTRATING TYPE
OF MECHANISM POSSIBLE FOR
ALIGNING GUN-SIGHT WITH EYE
POSITIONS.

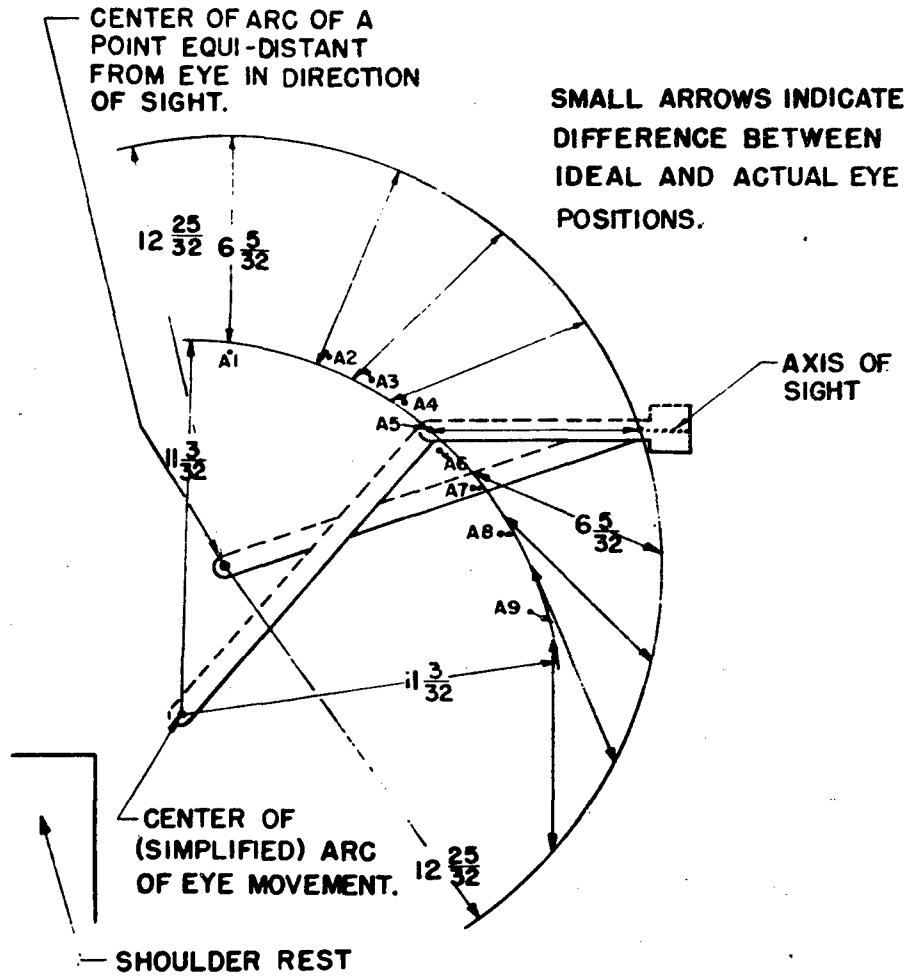

SCALE $\frac{1}{4}$

4533C-A M L

FIGURE 3
9 Figure VII, 3

The Design of Turret Sighting Panels

A turret sighting panel should be designed so that the deviation of the line of sight through the panel is zero or is constant for all angles of elevation and azimuth of the sight. If this is not done then an error in sighting is introduced as the guns are elevated or rotated. If the deviation is constant and the guns are harmonized with the sight while the panel is in position then there will be no error when the guns are moved. In order to eliminate the error introduced by a movement of the sight line in azimuth a cylindrical type panel which is flat in azimuth should be used.

The next problem is to determine the curvature of the panel which would give a constant deviation of the sight line for all angles of elevation of the sight. There are several methods of accomplishing this.

The first method is to construct the sighting panel using a series of flat plates. However, the seams formed by joining the plates together create blind areas which are very objectionable.

A second method is to make the sighting panel a true cylinder so that the axis of the cylinder coincides with the elevation axis of the sight. This can be done only if the sight moves in a true arc about a point when the angle of elevation is changed. In this case the angle of incidence of the sight line on the spherical section of the cylinder would be constant for all angles of elevation and, therefore, the deviation of this sight line would be constant. However, in most installations this would result in a very high dome as the sight usually pivots about a point near the gunner's ears and the radius of the cylinder would have to be long enough to allow clearances for the ammunition feeds, etc.

A third method is to make an elliptical panel with one focus at the point F_1 (see Figure VII, 4). This point should be on the horizontal line of sight in such a position that the lines of sight at various angles of elevation pass through or near it. Experiments have shown that when the line of sight at a given angle of elevation crosses the horizontal sight line as much as 1-1/2 inches from F_1 the error introduced is of the order of a few mils. Therefore, when designing a sighting panel for an upper turret it is particularly desirable that the line of sight for angles of elevation from 0° to 40° cross the horizontal sight line within $\pm 0.25"$ of F_1 . The next step is to measure a distance "h", along the line of sight at maximum depression, long enough to enable the panel to fit into a dome with a known base diameter. This diameter is fixed by the diameter of the turret. When selecting the distance "h" consideration should be given to the various types of mounting brackets and any pieces of equipment in the front part of the turret which must be cleared by the dome. The distance "h" locates the point A. Next a distance "g" should be measured along the line of sight at 90° elevation, this distance being high enough to give the proper clearances for head room etc. within the dome. In this way the point B can be located.

An ellipse through A and B with one focal point at F_1 can then be constructed

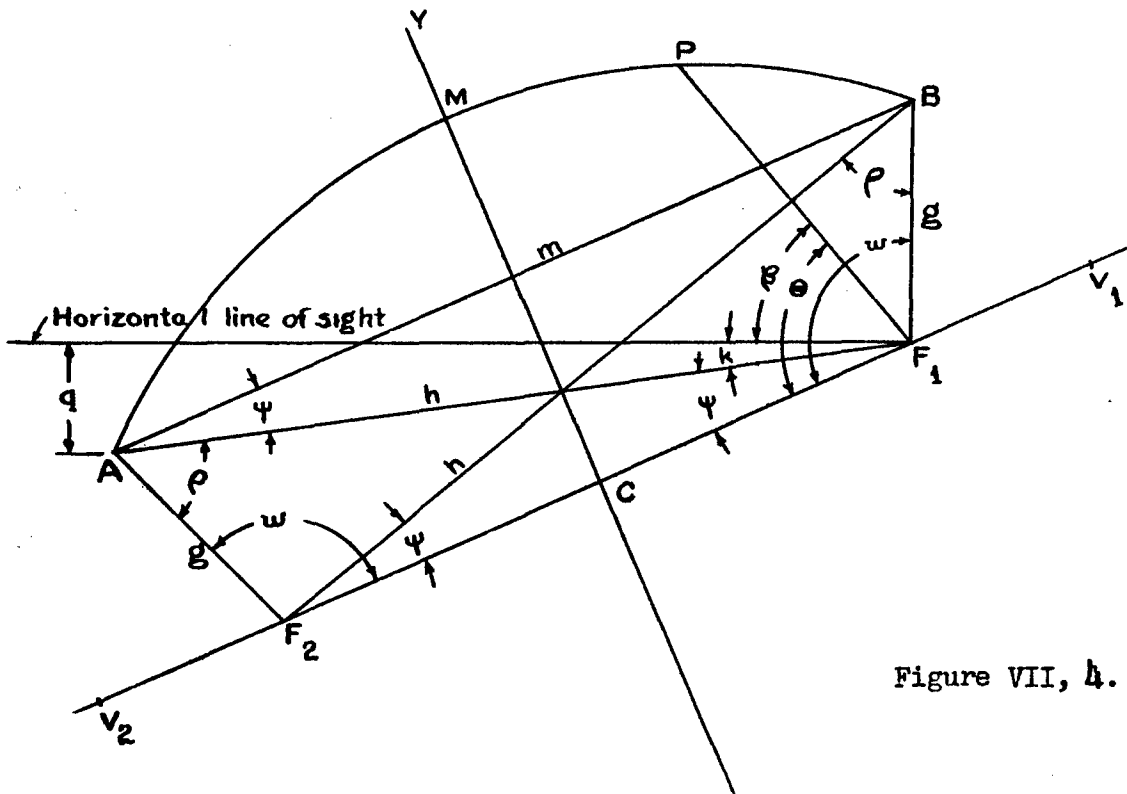

Figure VII, 4.

V_1 and V_2 are vertices of ellipse (on major axis)

M is vertex of ellipse (on minor axis)

Points A and B are symmetrical about minor axis of ellipse

C is center of ellipse

β = angle of elevation above horizontal sight line

θ = angle of elevation above major axis of ellipse

k = angle that line of sight along F_1A makes with horizontal sight line

w = angle that line of sight along F_1B makes with major axis of ellipse

ψ = angle that line of sight along F_1A makes with major axis of ellipse

ρ = angle F_1AF_2 = angle F_1BF_2

q = distance from A to horizontal sight line

$AB = m$ $F_1P = r$ $F_1A = F_2B = h$ $F_1B = F_2A = g$

$a = CV_1 = V_2C = 1/2$ major axis $b = CM = 1/2$ minor axis

$c = CF_1 = F_2C$

$$\sin k = \frac{q}{h}$$

$$a = \frac{h + g}{2}$$

$$m^2 = g^2 + h^2 - 2gh \cos(90^\circ + k)$$

$$c = \frac{g \sin \rho}{2 \sin \psi}$$

$$\sin \psi = \frac{g \sin(90^\circ + k)}{m}$$

$$b = \sqrt{a^2 - c^2}$$

$$\rho = 180^\circ - (w + \psi)$$

$$w = 90^\circ + k + \psi$$

as shown in the calculations under Figure VII, 1. By this construction the (Table I) points A and B are made symmetrical about the minor axis of the ellipse so that the radii of curvature and the angles of incidence of the lines of sight (assuming that they pass through F_1) at these two points are equal, thereby making the deviations equal. This is done by locating the other focal point F_2 at a distance "h" from B and a distance "g" from A.

Assuming that the line of sight at any angle of elevation passes through F_1 then the deviation of the sight line through any point P on the ellipse between A and B will not vary greatly as can be shown by carrying out the calculations below.

Actually, since the sight lines do not pass through F_1 the true deviation will vary from the computed value. However, from the figures given in Table I it can be seen that this error may be neglected. This table shows the total deviation of the sight line through the sighting panels used in the Sperry Upper Local Turret. At 10° elevation where the line of sight passes through F_1 there is a difference between the calculated deviation and the measured deviation. This is due partly to the assumptions made in the calculations, although the greatest part of this difference is probably due to the tolerances required in the process of bending the glass to the given form.

If more than one type of sight is used in the same turret and it is desired that the same panel be used to give similar sighting characteristics, it is necessary that the point F_1 remain fixed for all sight installations.

Relation of Eye Movement in Sighting to
Design of Turret Sighting Panels.

1. Technical Report No. 4887 discusses three possible designs of turret sighting panels, all based on movements of the gun-sight. The present study indicates what this gun-sight movement might be.

2. The above report favors an elliptical panel based on the intersections of lines of sight at various elevations. Location of the point F_1 (Figure VII, 4) is the crucial step in constructing this ellipse, but no method for its determination is presented - merely specifications which it should fill. This point can be located exactly by extending the lines of sight (Figure VII, 1) for 22.5° and 45° of elevation, back to where they cross the horizontal. The lines of sight up to and possibly beyond 45° of elevation cross the horizontal sight line within 0.25 inch of one another, exceeding the specifications by at least 5° .

3. The point B (Figure VII, 1), another critical point, is determined by a consideration of head clearance within the turret dome. In this connection, the following exact data, gathered by the Aero Medical Laboratory, Engineering Division, are pertinent: The average eye level from the seat for Army Air Forces flyers is 31.5 inches, and ranges from 30 to 34 inches. The average head height above the eyes is 5.1 inches and ranges from 4.5 to 5.7 inches. Three to five more inches should be allowed for leather and steel helmets, and for possible raising of the head to increase scanning visibility.

4. When looking directly upward, the average subject shortens his sitting height by 0.5 inch and tips his head back until the back of the head is 2 to 3 inches behind the plane of the back-rest. Space should be allowed behind the head for this, as well as for oxygen mask and tube clearance at all gun-sight elevations - critical matters in some turrets.

5. It will be noted that (Figure VII, 1) eye movement is virtually a circular arc from 90° above to 45° below horizontal. (This arc is perfect from 67.5° above to 25° below horizontal.) The mechanical problems of mounting and pivoting the gun-sight are thus simpler than if the curve were complex. One possible mechanical system is presented in Figure VII, 3. However, it would be better to draw the arc almost exactly through the points between 67.5° above and 45° or 67.5° below the horizontal, and to let the less important points, like 67.5° and 90° below, fall outside the arc. These points were obtained by not allowing the subject to bend forward at the trunk, as would naturally occur in looking straight down, in line with the general arc.

6. It may finally be noted that :

- a. The ear-hole does not move in a circular arc, as commonly supposed.
- b. The pivot point of eye or sight is not the ear-hole, but is roughly 2 inches below and $1/2$ inch behind it.

CHAPTER VIII

Appendices

1. Anthropometric Instruments
2. Head Dimensions
3. Male Body Dimensions
4. Female Body Dimensions
5. References

1. ANTHROPOMETRIC INSTRUMENTS

1. Anthropometer - This is a metal rod of approximately 7 feet in length which is calibrated in centimeters and millimeters and breaks down into 4 sections for packing and carrying. A slide works on the rod and a demountable spike fits through a sleeve in the slide. Another similar spike may be mounted at the top of the rod. Two scales are worked on the rod, one reading from the bottom up, the other from the top down. This instrument is used in all of the larger linear measurements of the body, e.g. stature, sitting height, chest breadth, etc.

2. Spreading Caliper - This is a compass-type instrument with the arms bowed so that their ends are opposed. The scale is calibrated in centimeters and millimeters from 0 to 30 and works through a slide attached to one of the arms. It is useful in taking linear measurements of small extent between points not accessible to the Sliding Caliper, e.g. head length, head breadth, etc.

3. Sliding Caliper - This consists of a flat metal bar upon which a slide moves. One end of the bar and the slide are equipped with points, sharp on one side, blunt on the other. The bar is scaled in centimeters and millimeters, 0 to 25.

4. Steel Tape - This is a 6-foot flexible steel tape in a metal case with spring rewind. It is scaled on one side in centimeters and millimeters and on the other in inches. (Lufkin Rule, Keuffel & Esser Wytface or equivalent).

The above instruments are calibrated on the metric system since all standard anthropometric work employs this scale. Thus a world-wide basis for comparison is available without laborious conversion from English inches to centimeters.

5. Tailor's Tape - A 60-inch, high grade, linen tape for use in taking tailors' dimensions of subjects. These tapes wear out rather rapidly under continual use and a supply of new tapes should be kept on hand.

6. Glove Tape - a cloth tape for measuring the circumference of the hand to determine glove size. The scale is French Rule. These tapes can be obtained from glove manufacturers but the use of any reliable cloth tape scaled in English Rule may be preferred.

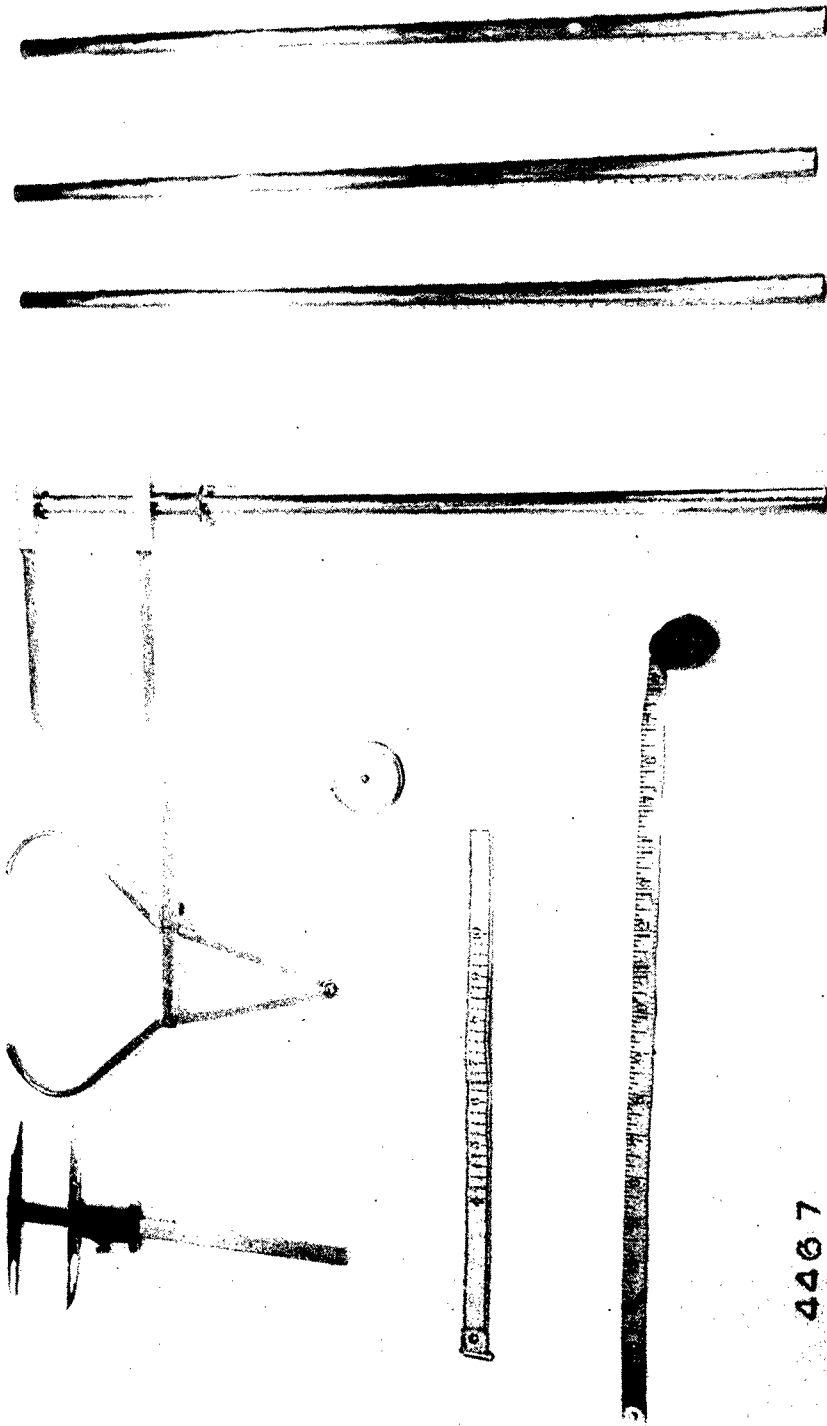

4467

Figure IX. J. 1.

2. TECHNIQUES FOR MEASURING THE HEAD

ANTHROPOMETER

1. Head Height: Head in horizontal plane determined by line joining bottom of bony orbit and the trasion point. Perpendicular height from trasion to mid-longitudinal line on top of head; average of readings for both sides. Traction is defined as the point where the tragus of the ear terminates superiorly, i.e., the superior corner, toward the head, of the main excavation (concha) of the external ear.

SPREADING CALIPER

2. Head Breadth: Greatest horizontal breadth of head above the ear openings, wherever found. Points of calipers held in horizontal plane and moved about until the maximum reading is obtained. Moderate pressure.

3. Minimum Frontal Diameter: Smallest distance between temporal crests, above surpa-orbital ridges. Moderate pressure.

4. Bi-Trasion: Distance between the two tragia (defined under Head Height). Contact only; no pressure.

5. Bizygomatic A.: Greatest breadth across zygomatic arches (the bone from cheek to ear), wherever found. Contact only. Mark points with skin pencil.

6. Bimalar: (1) On entire Kelly, Patterson, Wright, and half the Wilberforce series: distance between antero-lateral angles of malar (cheek) bones. Points are marked with a skin pencil, in the middle of the bone vertically. Contact only. (2) On the entire Maxwell, Wright, and Wilberforce series: head in horizontal eye-ear plane. Perpendiculars to this plane are dropped from the external canthi (corners) of the eyes, and marked on the mid-points, vertically, of the malars. Contact only. (3) On half the Wilberforce series: lower edge of malars, just medial to antero-lateral corner. Mark points. Contact only.

7. Bigonial: On mandible (lower jaw), distance between external gonial angles (corner where horizontal and ascending rami (branches) meet). Firm contact.

8. Head Length: Glabella (most anterior point of supra-orbital ridges, in mid-line) to opisthocranion (most posterior point of occiput (back of skull) in the mid-line). Moderate pressure.

Note: All single measurements of bilateral traits are taken from the left side.

9. Traction-Nasal Root: Traction (defined under Head Height) to deepest concavity of nasal root. Contact to skin only.

10. Traction-Subnasale: Traction (defined under Head Height) to juncture of nasal septum with philtrum (central hollowed region between nose and lip). Contact.

11. Otobasion Inferior-Philtrum: Otobasion inferior is the junction of the ear lobule with the cheek. To middle of philtrum (defined in preceding). Contact.

12. Otobasion Inferior-Supraorbitale: Otobasion inferior (see preceding) to median point of greatest concavity above the chin eminence and below the lower membranous lip. Contact.

13. Chin Projection, Menton-Gonion: Menton for this measurement is the most anterior point in the midline of the lower border of the mandible. Gonion is the postero-inferior angle of the horizontal and ascending rami of the lower jaw. Firm pressure on both points.

SLIDING CALIPER

14. Crinion-Menton Face Height: Crinion is the lowest point reached by the hair in the forehead midline. If hair has been lost from this region, the measurement is not taken. The fixed point of the caliper is placed on menton (for this measurement, the mid-point of the inferior border of the mandible). Firm pressure on menton.

15. Nasion-Menton Face Height: Nasion (the middle of the naso-frontal suture) is palpated and marked. Fix caliper on menton (see preceding).

16. Upper Face Height, Nasion-Prosthion: Nasion (see preceding) to inferior tip of gum between the two central upper incisors.

17. Nose Height: Nasion to subnasale (junction of septum with philtrum).

18. Nose Length: (1) On entire Kelly, Wright-Patterson, and Wilberforce series, nasion to middle of most prominent part of nasal tip in lateral view. (2) On entire Maxwell, Wright, and Wilberforce series, nasion to most inferior point on midline of nasal tip.

20. Nasal Root Breadth: (1) On entire Kelly, Wright, Patterson, and Wilberforce series, distance between frontal processes of maxillae, just inside internal canthi (corners) of eyes. Firm contact.

21. Nasal Root Breadth: (2) On Maxwell, Wright, and Wilberforce series, distance between naso-maxillary junctures. (Breadth across nasal bones themselves at superior lateral borders.) Firm contact.

22. Nasal Bridge Breadth: Palpate distal (lateral) ends of bony side walls of nasal skeleton. Maximum breadth at juncture of cheek and side wall of nasal bridge. Firm contact.

23. Nasal Base Breadth (alae): Breadth across alae (wings) of nose, nostrils at rest and not flared. Contact.

24. Nasal Root Salient: Internal canthus (corner) of eye to midline of summit of nasal root. Minimum distance.

25. Nasal Bridge Salient: (1) On Kelly, Wright, Patterson, and Wilberforce series, juncture of side wall of nasal bridge with cheek, to middle of summit of nasal bridge. Palpate bottom of bony side wall of bridge, and mark. Contact measurement to middle of nasal bridge perpendicular to bridge line. (2) On Maxwell series, perpendicular from tip of bony bridge in midline of nose, to juncture of bony side-wall with cheek.

26. Nasal Tip Salient: Alare (junction of nasal ala (wing) with cheek) to pronasale (midpoint of most prominent portion of nasal tip in lateral view.)

27. Nasal Tip Height: Subnasale (junction of philtrum and septum) to pronasale (most outstanding point on middle of tip).

28. Biocular Diameter: Distance between outer angles of the external canthi (corners) of the eyes. Eyes opened wide and directed upward. Taken with caliper ends directed upward.

29. Interocular Diameter: Distance between internal canthi. Measurement taken from below.

30. Ear Implantation Length: Otobasion superior (superior juncture of external ear with side of head) to otobasion inferior (junction of lobule with cheek.) Pointed ends of caliper.

31. Ear Length, Maximum: Maximum distance along axis of ear, wherever found.

32. Mouth Breadth: Distance between two corners of mouth, to edge of line of lip juncture, not necessarily to edge of membrane. Mouth in natural position; contact only; pointed ends of caliper.

33. Mandible Height: Fixed end of caliper on menton (mid-point of inferior border of mandible), measure to superior point of gum between the two central lower incisors. Firm pressure on menton.

34. Chin Breadth: Maximum breadth of mental eminence (chin) at juncture of confluence with lower border of the body of the mandible. Determine and mark intersection of the curve of the lower border of the chin meets the curve of the lower border of the mandibular corpus (body). Palpation may be necessary. Contact only.

35. Chin-Neck Projection: (1) Kelly, Wright, Patterson, and Wilberforce series: subject in horizontal eye-ear plane. Menton (in this measurement, the most anterior point in the midline of the lower border of the mandible) to juncture of chin with neck. Bar of caliper firmly against tip of thyroid cartilage (Adam's apple), caliper held horizontally.

36. Chin-Neck Projection: (2) Maxwell series: straight line distance between tip of thyroid cartilage and menton. Angle of caliper variable.

37.&38. Neck Breadth: Breadth of neck at the middle. Contact only.

39. Neck Depth: Thyroid cartilage to back of neck perpendicular to axis of neck. Contact only.

"Orientation Values."

The head is first set firmly in a square, consisting of one board parallel and one perpendicular to the floor, and is then placed in a horizontal plane determined by a line joining the bottom of the bony orbit and the tragion point. The horizontal arm of the square is then tangent to the vertex; and the vertical arm, to the occiput.

ANTHROPOMETER

40. Horizontal-Tragion: Distance from horizontal board to point where the tragus of the ear terminates superiorly, i.e. the superior corner, toward the head, of the main excavation (concha) of the external ear. Anthropometer vertical. Average of readings for each side.

41. Wall-Tragion: Distance from vertical board to tragion. Anthropometer horizontal. Average of readings for each side.

42. Wall-Otobasion: Distance from vertical board to junction of ear lobule with cheek.

43. Wall-Thyroid Cartilage: Vertical board to anterior point of thyroid cartilage. Contact only, to skin.

44. Wall-Menton: Vertical board to most anterior point in midline of lower border of the mandible.

45. Wall-External Canthus: Vertical board to outer angle of external canthus (corner) of eye. Average of readings for each side.

46. Horizontal-Canthus: From horizontal board to outer angle of external Canthus. Average of two readings.

47. Horizontal-Nasion: Horizontal board to middle of naso-frontal suture.

For the following measurements, the square is removed from the subject's head.

SLIDING CALIPER

48. Tragion-Gonion: Tragion to postero-inferior angle of the horizontal and ascending rami of the mandible (lower jaw). Contact, to skin. Left side.

49. Subnasale-Canthus: A distance (straight line) from the junction of the nasal septum with the upper lip to the outer corner of the eye.

50. Tragion-Otobasion: (Both points defined above). Left side.

51. Otobasion-Canthus: (Both points defined above.) Left side.

52. Menton-Supramentale: Menton for this measurement is the mid-point of the inferior border of the mandible. Supramentale is the median point of greatest concavity above the chin eminence and below the lower membranous lip.

53. Menton-Philtrum: Menton (as defined in the preceding paragraph) to central hollowed region between nose and upper membranous lip.

54. Canthus-Malar: External canthus to point in middle, vertically of the malar (cheek) bone. The point is determined by dropping from the external canthus a perpendicular to the horizontal (tragion-lower border of orbit) plane in which the head is fixed. Contact only; left side.

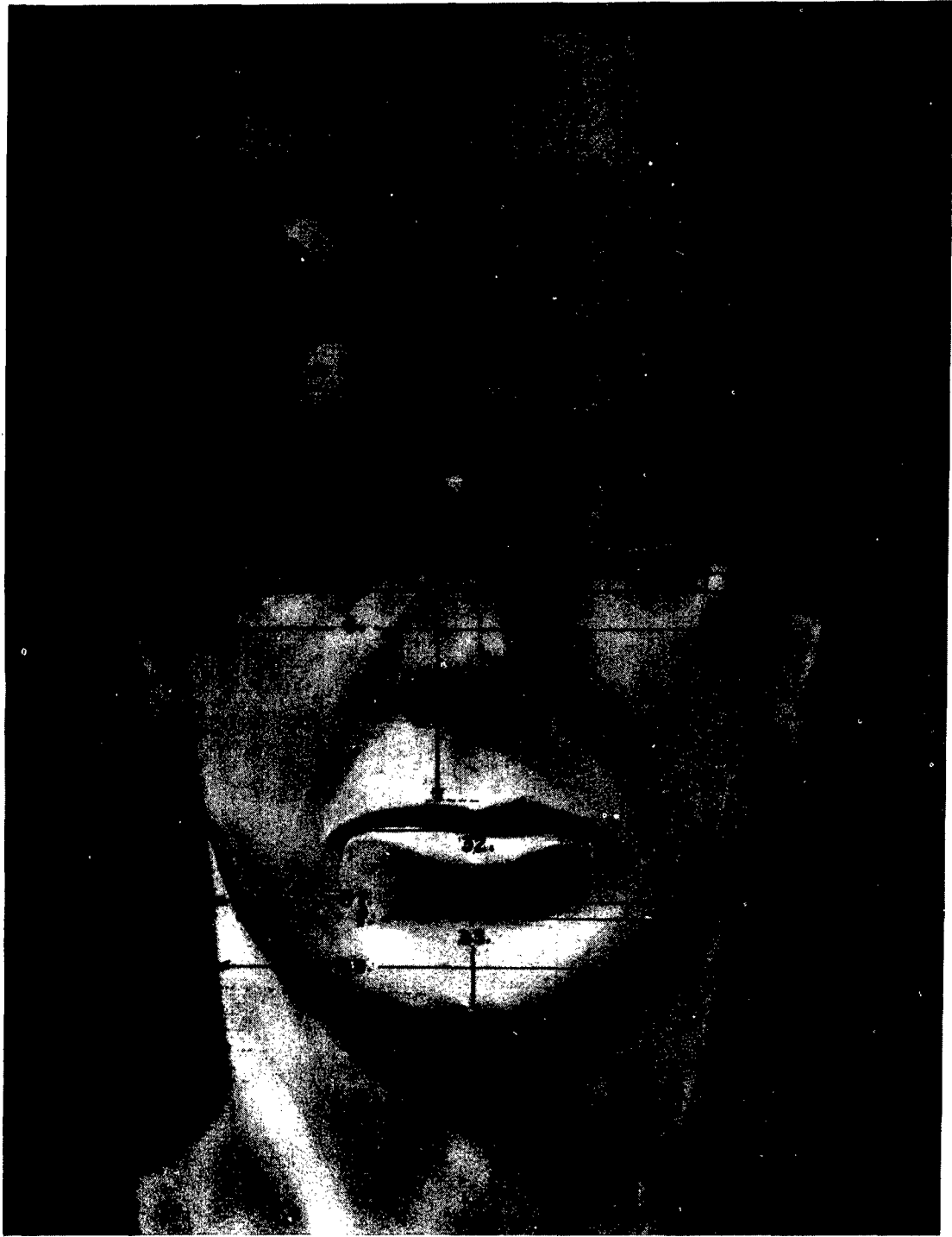
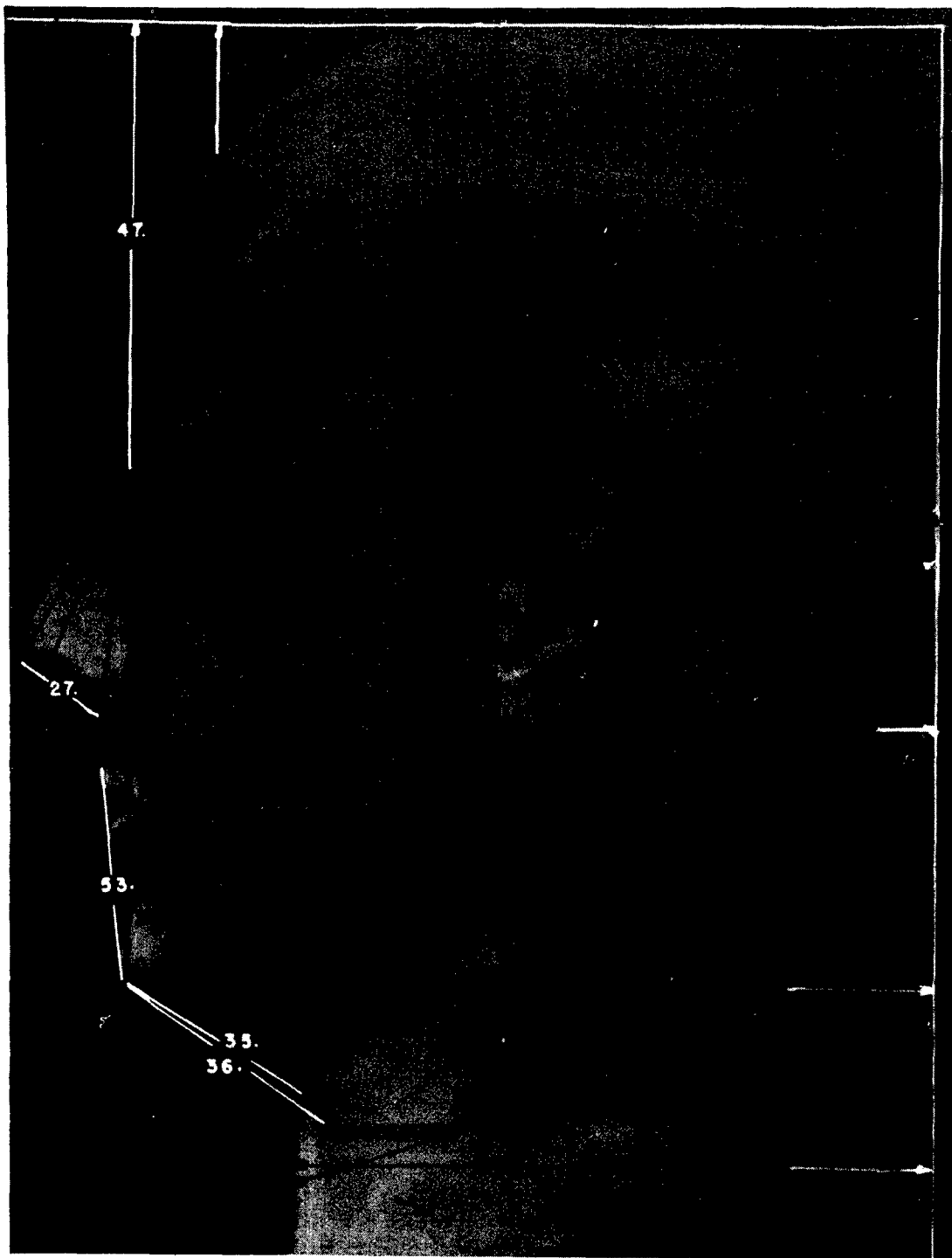

Figure 1X, 2, 1



NAME	(last)	(first)	(middle)	Observer	Date
Col. Pouch					
1 LOCATION				TRAGION—SUBNASALE	21
2 MILITARY UNIT				OTOBASION INF.—PHILTRUM	22
3 RANK: private ³ non-com. ¹¹ officer ¹⁰				OTOBASION INF.—SUPRAMENTALE	23
INDUCTION BASIS: selectee ¹ volunteer ² reserve ⁴				CHIN PROJ'N—MENTON—GONION	24
4 AGE	(last birthday)			SIDING CALIPER	
5 BIRTHPLACE — SUBJECT	(State, if U.S.A.; or country, if foreign)			CRINION—MENTON FACE HT.	25
6 BIRTHPLACE — FATHER	(State, if U.S.A.; or country, if foreign)			NASION—MENTON FACE HT.	26
7 BIRTHPLACE — MOTHER	(State, if U.S.A.; or country, if foreign)			UPPER FACE HT.	27
8 NATIONAL EXTRACTION	(Two principal strains)			NOSE HEIGHT	28
9 RELIGIOUS AFFILIATION (Familia): Protestant ¹² Catholic ¹¹ Jewish ¹⁰ Other ¹				NOSE LENGTH (to PRONASALE)	29
EDUCATION (Highest Schooling): illiterate ² read and write ³ grade ⁴ high ⁵ special training (tech., bus., etc.) ⁶ college ⁷ prof. ⁸				NASAL ROOT BREADTH	30
10 OCCUPATION (principal)				NASAL BRIDGE BREADTH	31
11 RACE: White ² Negroid ⁸ Mongoloid ⁴ Other ⁵				NASAL BASE BREADTH (alae)	32
HEAD HEIGHT				NASAL ROOT SALIENT	33
ANTHROPOMETER				NASAL BRIDGE SALIENT	34
HEAD BREADTH				NASAL TIP SALIENT	35
SPREADING CALIPER				NASAL TIP HEIGHT	36
MINIMUM FRONTAL				BIOCULAR DIAMETER	37
BI-TRAGION				INTEROCULAR	38
BIZYGOMATIC				EAR IMPLANTATION LENGTH	39
BIMALAR				EAR LENGTH, MAXIMUM	40
BIGONIAL				MOUTH BREADTH	41
HEAD LENGTH				MANDIBLE HT.—INFRAD.—MENT.	42
TRAGION—NASAL ROOT				CHIN BREADTH	43
				CHIN-NECK PROJECTION	44
				NECK BREADTH	45
				NECK DEPTH	46

4518A A M L

Figure IX, 2, 3.

Facial Survey of Aviation Cadets.

	<u>Number</u>	<u>Mean</u>	<u>Range</u>
Age	1454	23 yrs. 4 mos.	18-27
1. Head Height	1246	130.5 mm.	110-148
2. Head Breadth	1443	153.9	138-172
3. Minimum Frontal	1452	105.8	92-120
4. Bi-Tragion	1453	144.7	124-160
5. Bizygomatic	1453	142.4	117-162
6. Bimalar	358	108.5	92-128
7. Bigonial	1454	106.5	87-123
8. Head Length	1452	197.5	172-218
9. Tragion-Nasal Root	1451	125.3	109-139
10. Tragion-Subnasale	1445	129.8	115-145
11. Otobasion Inferior-Philtrum	909	116.4	102-131
12. Otobasion Inferior-Supramentale	1454	115.0	95-132
13. Chin Projection, Menton-Gonion	1095	99.9	83-119
14. Crinion-Menton Face Height	1320	185.0	157-214
15. Nasion-Menton Face Height	1451	123.2	102-145
16. Upper Face Height	900	73.5	59-86
17. Nose Height	1247	56.0	45-69
18. Nose Length (Pronasale)	K 1093	48.6	35-63
19. Nose Length (Pronasale)	M 358	54.9	42-64
20. Nasal Root Breadth	K 1095	23.9	17-33
21. Nasal Root Breadth	M 358	15.3	11-25
22. Nasal Bridge Breadth	1450	32.2	24-41
23. Nasal Base Breadth (alae)	1452	35.3	28-43
24. Nasal Root Salient	1453	24.0	18-30
25. Nasal Bridge Salient	1451	29.3	22-40
26. Nasal Base Salient	909	34.7	28-42
27. Nasal Tip Height	1246	21.5	15-29
28. Biocular Diameter	1450	93.0	82-108
29. Interocular	1453	32.2	24-42
30. Ear Implantation Length	1454	52.8	42-66
31. Ear Length, Maximum	1299	65.0	52-79
32. Mouth Breadth	1300	51.8	42-63
33. Mandible Height	901	40.9	32-56
34. Chin Breadth	1093	61.2	46-75
35. Chin-Neck Projection	K 1096	46.6	27-69
36. Chin-Neck Projection	M 354	55.0	37-74
37. Neck Breadth	909	118.1	103-140
39. Neck Depth	1454	118.9	103-140

"Orientation Values."

Size of series - 198

	<u>Mean</u>	<u>Range</u>
40. Horizontal-Tragion	130.3	115-144
41. Wall-Tragion	96.9	75-110
42. Wall-Otobasion	104.6	86-123
43. Wall-Thyroid Cartilage	147.6	122-204
44. Wall-External Canthus	191.2	172-222
45. Wall-External Canthus	171.5	150-188
46. Horizontal-Canthus	114.5	90-136
47. Horizontal-Nasion	102.6	75-129
48. Tragion-Gonion	64.8	49-82
49. Subnasale-Canthus	72.8	62-86
50. Tragion-Otobasion	32.0	25-46
51. Otobasion-Canthus	89.9	72-104
52. Menton-Supramentale	27.5	20-37
53. Menton-Philtrum	62.3	51-78
54. Canthus-Malar K	27.5	19-34
Canthus-Malar M	28.7	22-35

All measurements are in millimeters.

3. TECHNIQUES FOR MEASURING THE BODY

1. Weight: In pounds.
2. Stature: Heels together, toes at 45° angle. Back straight, head in horizontal plane defined by line from tragion (about top of ear hole) to bottom of bony orbit. Measure from front or back, with anthropometer vertical, to vertex (highest point in midline of head).
3. Total Span: Observer hold anthropometer horizontally, subject pushes movable arm with left hand. Distance between tips of middle fingers. Maximum stretch without straining.
4. Anterior Arm Reach: Heels together; heels, buttocks, middle of back (in lateral sense), and occiput against wall. Require subject to attain maximum horizontal forward reach, with contacts maintained. Both arms horizontal, extended equally. Distance from wall to tip of right middle finger.
5. Span-Akimbo: Arms flexed, held horizontally, palms down, fingers straight and together; thumbs touching chest; wrists straight. Fingers of each hand do not meet. Anthropometer bar must be horizontal and in contact with back and elbows, the latter being manipulated as required. Measure from behind. Distance between two elbow points, Not necessarily a maximum distance.
6. Biacromial: Distance between acromial points (external borders of end of scapular (shoulder-blade) spine). Be sure subject is relaxed, but not collapsed. Firm contact.
7. Bi-deltoid: Arms at side, palms forward. Maximum contact dimension across deltoids (large muscles around shoulders).
8. Chest Breadth: Flat portion of anthropometer against chest at nipple level. Use only moderate pressure.
9. Chest Depth: Horizontal antero-posterior dimension at nipple level. Contact to sternum (breast bone); fixed arm of anthropometer in spinal groove.
10. Abdominal Depth: Maximum horizontal contact dimension, wherever found.
11. Bi-iliac: A firm pressure dimension, maximum iliac brim (across hip bones). Heels together.
12. Head Circumference: Maximum of three attempts.
13. Chest Circumference: Horizontal circumference just above nipples. Do not tighten the tape; merely contact all around. Chest neither expanded nor collapsed; take during quiet breathing.
14. Upper Arm Circumference: Horizontal circumference at the maximum of the biceps muscle.
15. Forearm Circumference: Circumference taken halfway between elbow and wrist.

16. Arm Length: Length of arm from top of clavicle to the tip of the middle finger as the arm hangs at the side of the body.

17. Forearm Length: Distance from elbow to middle finger tip with the forearm flexed at the elbow.

18. Hand Length: Right hand, fingers extended and together, palm up. Distance from proximal end of navicular (small wrist bone at base of thumb) to tip of middle of middle finger. Fixed end of caliper firmly pressed against navicular, light contact to finger tip.

19. Hand Breadth: Right hand, fingers extended and together, palm up. Arms of caliper parallel to axis of fingers. Distance between radial (lateral) projection of distal end of second metacarpal, and ulnar (medial) projection of distal end of fifth metacarpal. Firm contact.

20. Wrist Breadth: Thickness of the wrist at the level of the two bony projections just above the wrist joint. Firm contact.

21. Wrist Thickness: A dimension transverse to 20.

22. Shoulder-elbow: Trunk erect, humerus vertical, forearm horizontal. Measure from top of acromion process to bottom of elbow.

23. Elbow-seat: Distance from elbow as measured in 22 to level of seat.

24. Bi-epicondylar, elbows: Humeri vertical; arms pushed medially until they touch trunk wall. Hands on sides of thighs, knees together and right-angled, trunk erect. Distance between lateral epicondyles of humeri (outer projections of elbows).

25. Bi-trochanteric: Knees together and at right angles, trunk erect. Maximum lateral diameter of buttocks; light touch measurement. Anthropometer horizontal.

26. Thigh Circumference: Horizontal circumference of thigh halfway between crotch and knee.

27. Calf Circumference: Weight even on both feet. Left calf, maximum horizontal, of three attempts.

28. Xiphoid Height: Vertical distance, subject standing, from juncture of sternum and xiphoid process to floor.

29. Lower Rib Height: Vertical distance, subject standing, from lower margin of last rib, viewed laterally, to floor.

30. Umbilical Height: Vertical distance, subject standing, from center of umbilicus to floor.

31. Iliac Crest Height: Vertical distance, subject standing, from top of the iliac crest viewed laterally, to the floor.

32. Pubic Height: Vertical distance, subject standing, from the upper margin of the pubic symphysis to the floor. The pubic symphysis lies below the umbilicus, and is the upper margin of the pelvic bone in the mid line.

33. Crotch Height: Vertical distance, subject standing, from crotch to floor.

34. Sitting Height: Subject back on table as far as possible, until backs of knees hit table edge. Legs dangle freely. Trunk as erect as possible; head in eye-ear horizontal, as in stature. Measure from rear.

35. Trunk Height: Trunk in same position as above. Distance from table to topmost margin of bony sternum (breast-bone) palpated. Disregard suprasternal bones. Measure from front.

36. Buttock-knee: Right Side. Trunk erect. Knees together and knee angle at right angle; thighs horizontal. Contact measurement, buttock to skin over patella (knee-cap).

37. Patella Height: Right Side. Leg in right angle position. Base of anthropometer near base of heel. Contact to top of muscle mass near end of femur (thigh bone). A maximum height.

38. Standing Knee Height: Vertical distance, subject standing, from top of knee bone, patella, to floor.

39. Bi-epicondylar, femoral: Knees at right angles, feet together, medial epicondyles of femora in firm apposition. Distance between lateral epicondyles (lateral projections of knees).

40. Foot Length: Weight even on both feet. Left foot, maximum contact from heel to great toe (or second, if longer).

41. Foot Breadth: Weight even on both feet. Left foot, maximum breadth with arms of anthropometer parallel to long axis of leg and foot. Light pressure.

42. External Malleolar Height: Vertical distance from lower leg bone, just above the ankle, on the outside to the floor.

43. Internal Malleolar Height: Vertical distance from lower leg bone, just above the ankle, on the inside to the floor.

44. Ankle Breadth: Distance between the two bony projections of the lower leg at the ankle.

45. Ankle Thickness: Fore-aft distance between front and back of ankle at the level at which 44 was taken.

46. Face Length: Distance from the most depressed part of the root of the nose to the tip of the chin in the midline of the face.

PERCENTILE DISTRIBUTION - HOW TO USE THEM

Percentile distributions (calculated for all metric characters) are offered as the most practical elaboration of statistics for the present purposes. They show what measurement values would accommodate percentages of cadets or gunners from five to ninety-five. By subtraction, per cent. of series between any given values can be ascertained. Other percentages may be obtained by interpolation. If a turret dimension is fixed, by reference to the table it can be decided what proportion of cadets or gunners fall within that dimension and can be accommodated by it, or exceed it. The median (50 per cent.) is in these series practically equivalent to the arithmetic mean. The total range of measurements is also given. It should be borne in mind, however, that the ranges may be unduly extended by cases which represent errors in recording. The most obvious errors have been eliminated, but some less flagrant ones may remain. The percentile distributions are given in Tables 1-29.

Serial No. U. S. ARMY AIR CORPS-- MATERIEL DIVISION -- ANTHROPOLOGICAL SURVEY

NAME	Observer	Date
<small>(Last)</small>	<small>(Initial)</small>	
01. <small>Front</small> 1 LOCATION	02. <small>Front</small> 12 HAIR COLOR: black ¹ dk. brown ² med. brown ³ red brown ⁴ gold brown ⁵ ash brown ⁶ golden ⁷ ash ⁸ red ⁹	
2 MILITARY UNIT	13 HAIR FORM: straight ¹ low wave ² deep wave ³ curly ⁴ frizzly or woolly ⁵	
3 RANK: private ¹ non-com. ² officer ³ INDUCTION BASIS: selectee ¹ volunteer ² reserve ³	14 EYE COLOR: pure dark (dk. or lt. brown) ¹ pure light (gray, blue, gray-blue) ² mixed light ³ mixed even ⁴ mixed dark ⁵	
4 AGE	15 SKIN COLOR: pale ¹ med. pink ² florid or ruddy ³ brnet ⁴ swarthy ⁵ yellow brown ⁶ dk. brown ⁷ black ⁸	
5 BIRTHPLACE -- SUBJECT:	16 VASCULARITY: (scratch on chest) abs. ¹ subm. ² med. ³ pron. ⁴	
6 BIRTHPLACE -- FATHER:	SOMATOTYPE:	
7 BIRTHPLACE -- MOTHER:	17 ENDOMORPHY 1-2-3-4-5-6-7	
8 NATIONAL EXTRACTION (Two principal strains)	18 MESOMORPHY 1-2-3-4-5-6-7	
9 RELIGIOUS AFFILIATION (Familial): [Protestant ¹] Catholic ² Jewish ³ Other ⁴	19 ECTOMORPHY 1-2-3-4-5-6-7	
EDUCATION (Highest Schooling): [illiterate ¹] read and write ² grade ³ high ⁴ special training (tech., bus., etc.) ⁵ college ⁶ prof. ⁷	20 ANDROGYNY: 1-2-3-4-5-6-7	
10 OCCUPATION (principal)	21 DYSPLASIA: 1-2-3-4-5-6-7	
11 MARITAL STATUS: single ¹ married ² divorced or separated ³ widower ⁴	22 MUSCLE TONUS: <i>sem.</i> (totally relaxed) ¹ <i>sm.</i> (soft) ² + (med.) ³ ++ (tense) ⁴	
RACE: White ¹ Negroid ² Mongoloid ³ Other ⁴		

Subject Standing		Obs.	Front	Back	Subject Sitting		Obs.	Front	Back
WEIGHT	23				NOSE LENGTH	52			
STATURE	24				NOSE BREADTH	53			
SPAN -- TOTAL	25				HAND LENGTH	54			
ANTERIOR ARM REACH	26				HAND BREADTH	55			
SPAN -- AKIMBO	27				Indices				
BIACROMIAL	28				HEIGHT (in.) / ³ WT. (lb.)	56			
BI-DELTOID	29				SITTING HEIGHT/STATURE	57			
CHEST BREADTH	30				CHEST BREADTH/BIACROMIAL	58			
CHEST DEPTH	31				CALF/BIACROMIAL	59			
ABDOMINAL DEPTH	32				CHEST D./BIACROMIAL	60			
BI-ILIAC	33				BI-ILIAC/BIAC.	61			
FOOT LENGTH	34				HEAD CIRC./CHEST CIRC.	62			
FOOT BREADTH	35				CHEST CIRC./STATURE	63			
HEAD CIRCUM.	36				CHEST D./CHEST BR.	64			
CHEST CIRCUM. (rest)	37				HEAD BR./HEAD L.	65			
CALF CIRCUM. (left)	38				FACE L./FACE BR.	66			
Subject Sitting					NOSE BR./NOSE L.	67			
SITTING HEIGHT	39					68			
TRUNK HEIGHT	40					69			
BUTTOCK-KNEE	41					70			
PATELLA HEIGHT (from floor)	42					71			
BI-EPICONDYLAR (elbows)	43					72			
BI-TROCHANTERIC	44					73			
BI-EPICOND. FEMORAL (knees)	45					74			
SHOULDER-ELBOW HEIGHT	46					75			
SQUATTING DIAGONAL	47					76			
HEAD LENGTH	48					77			
HEAD BREADTH	49					78			
FACE BREADTH	50					79			
FACE LENGTH	51					80			

4518B-A M L

Figure IX, 3, 1.

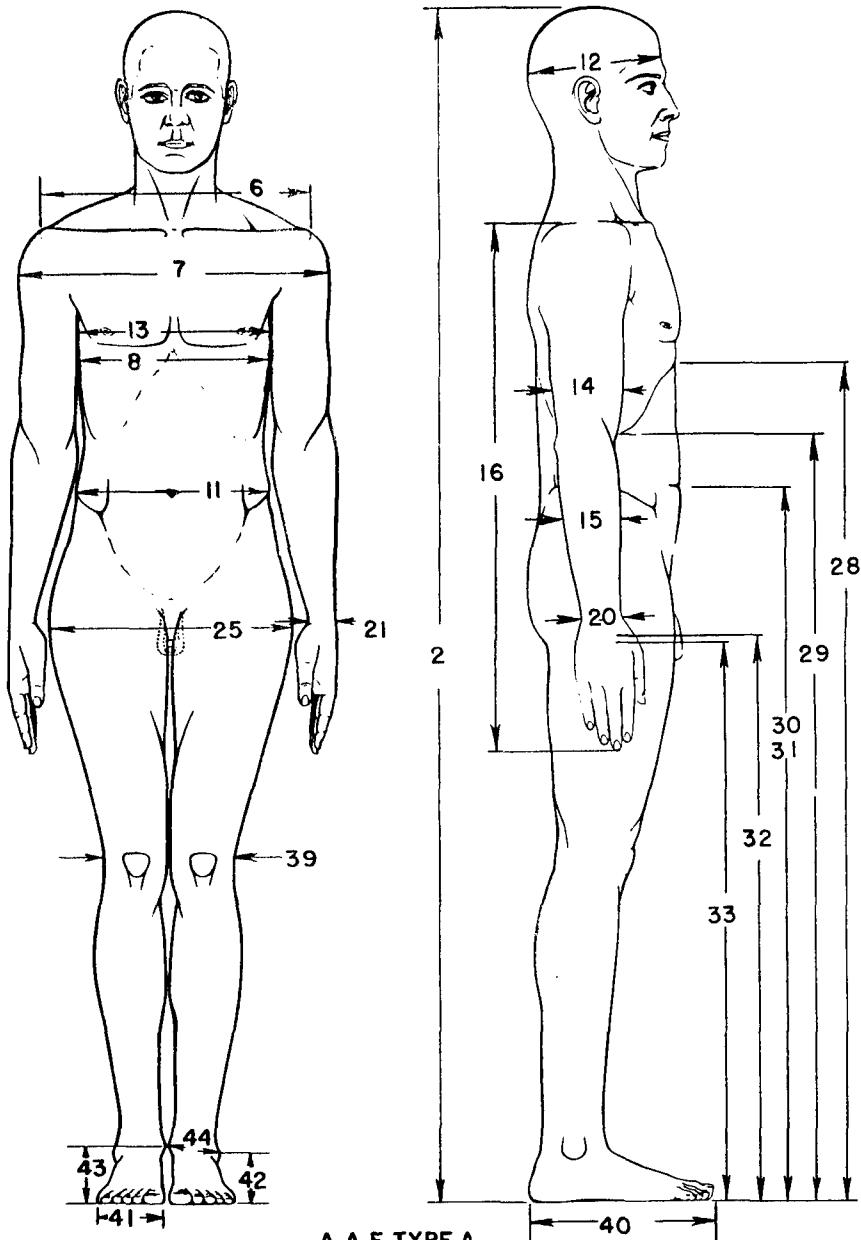

A.A.F. TYPE A.

4408 C

238.

Figure IX, 5, 2.

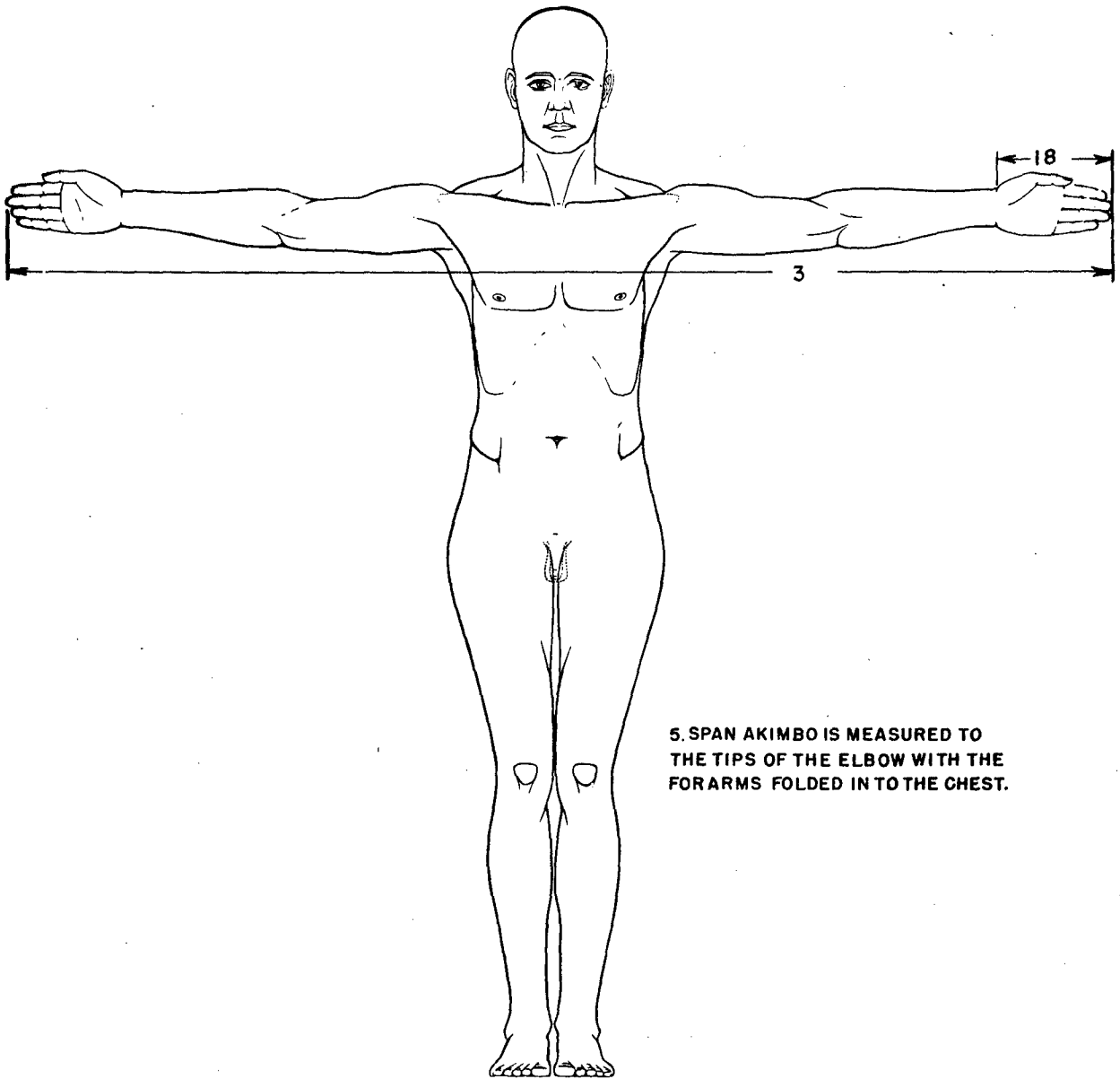

5. SPAN AKIMBO IS MEASURED TO THE TIPS OF THE ELBOW WITH THE FORARMS FOLDED INTO THE CHEST.

A.A.F. TYPE A.

4408 A

Figure IX, 3, 3.

239.

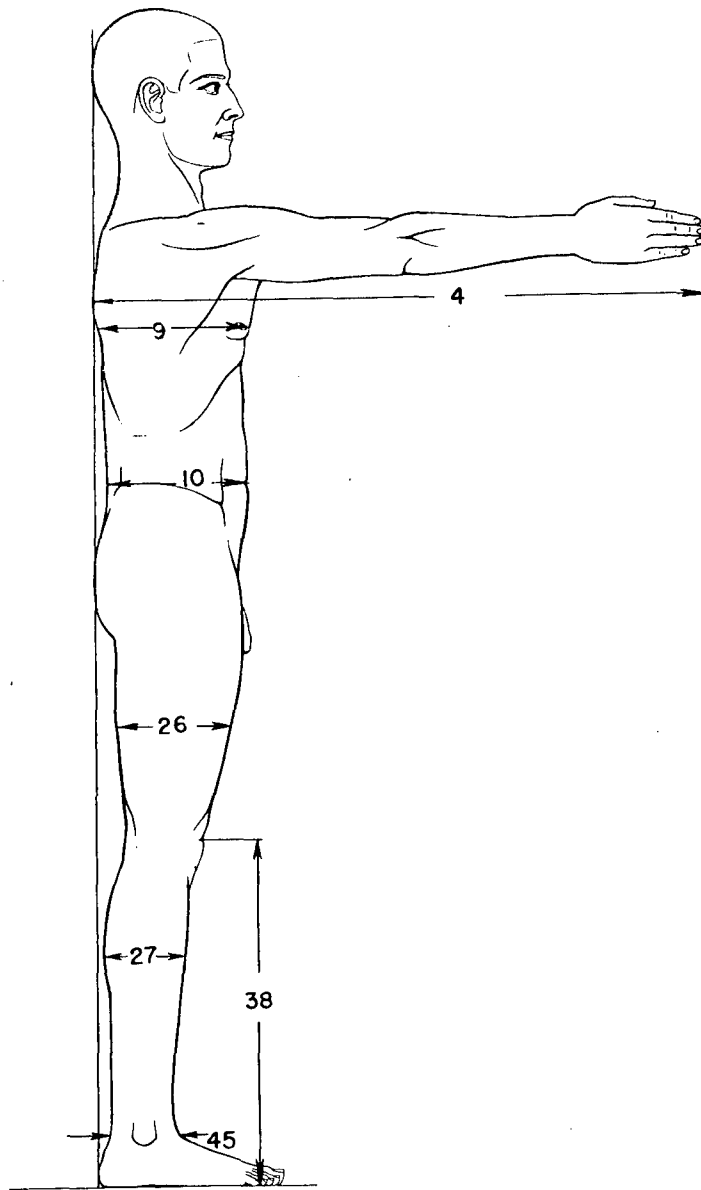

A.A.F. TYPE A

4 408 B

Figure D, 3, 1.

240.

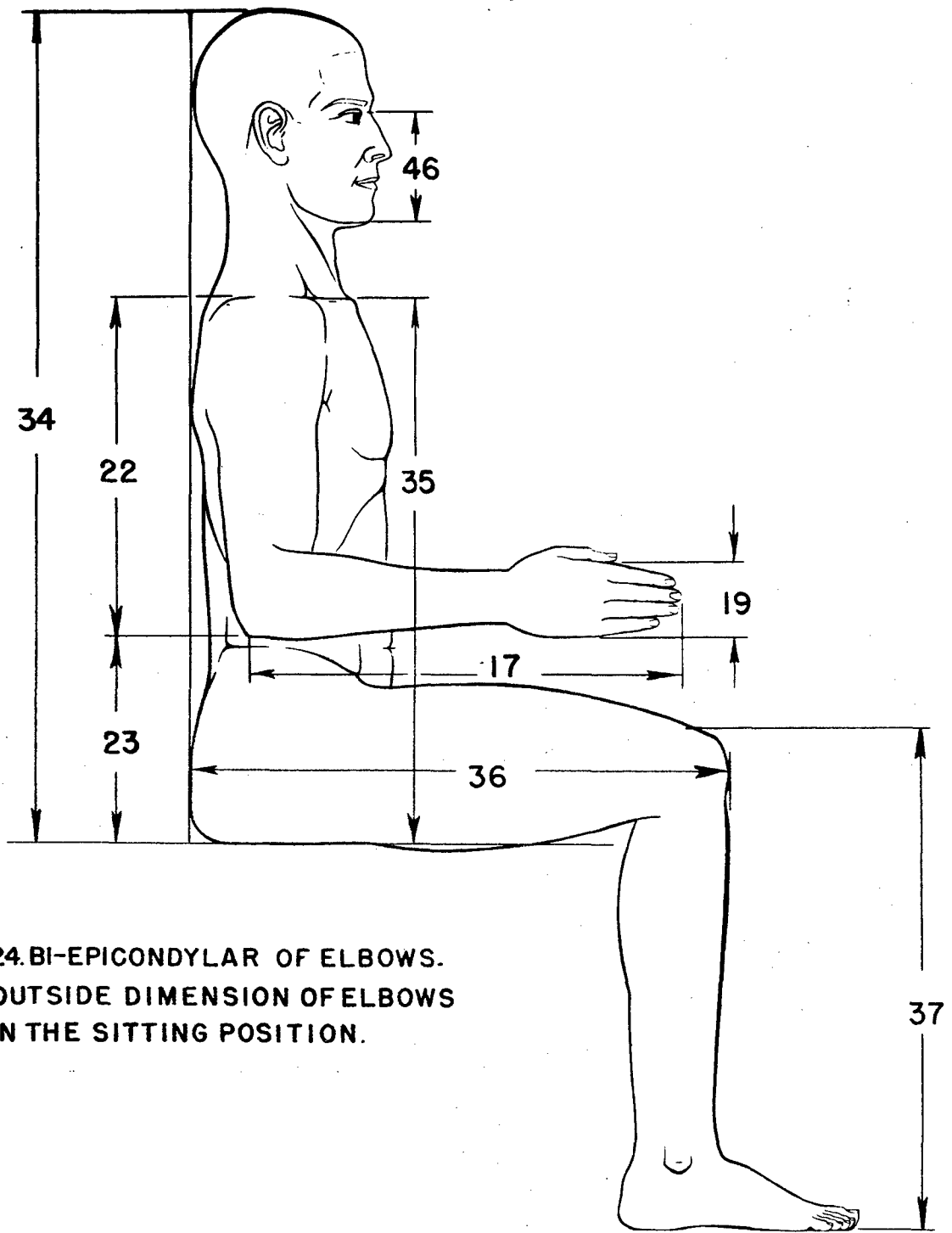

24. BI-EPICONDYLAR OF ELBOWS.
 OUTSIDE DIMENSION OF ELBOWS
 IN THE SITTING POSITION.

A.A.F. TYPE A

4408

Figure IX, 3, L.

241.

TABLE 1

WEIGHTDistribution in PercentilesWeight in Pounds

Percentiles	Cadets	Gunners
5%	128.54	119.74
10%	133.81	125.04
15%	137.17	131.01
20%	139.75	133.63
25%	142.13	136.23
35%	146.51	140.95
40%	148.65	142.91
45%	150.81	144.64
50%	153.12	147.07
55%	155.27	149.37
60%	157.42	150.85
65%	159.90	152.79
70%	162.37	155.64
75%	165.48	157.45
80%	168.76	160.42
85%	172.74	163.63
90%	177.43	166.73
95%	184.04	173.30

Number: 2960
 Range: 110-210
 Median: 153.12

Number: 584
 Range: 108-203
 Median: 147.07

TABLE 2

STATUREDistribution in PercentilesStature in Centimeters and Inches

Percentiles	Cadets		Gunners	
	Cm.	Inches	Cm.	Inches
5%	166.08	65.4	161.02	63.4
10%	168.00	66.1	163.35	64.5
15%	169.35	66.7	165.56	65.2
20%	170.49	67.1	166.35	65.7
25%	171.43	67.5	168.21	66.2
30%	172.51	67.9	169.10	66.6
35%	173.42	68.3	170.05	66.9
40%	174.22	68.6	171.01	67.3
45%	174.94	68.8	171.66	67.6
50%	175.67	69.2	172.41	67.9
55%	176.48	69.5	173.31	68.2
60%	177.34	69.8	174.22	68.6
65%	178.15	70.2	174.96	68.9
70%	178.97	70.5	175.77	69.2
75%	179.90	70.8	176.62	69.5
80%	181.02	71.3	177.48	69.9
85%	182.20	71.7	178.38	70.2
90%	183.79	72.4	180.05	70.9
95%	185.85	73.1	182.25	71.7

Number: 2961
 Range: 156-198 (61.4-78.0)
 Median: 175.67 (69.2)

Number: 584
 Range: 151-190 (59.4-74.3)
 Median: 172.41 (67.9)

TABLE 3

SPAN-TOTALDistribution in PercentilesSpan-total in Centimeters and Inches

Percentiles	<u>Cadets</u>		<u>Gunners</u>	
	Cm.	Inches	Cm.	Inches
5%	170.60	67.2	165.60	65.2
10%	172.91	68.0	168.19	66.2
15%	174.14	68.7	170.10	66.9
20%	175.73	69.2	172.09	67.7
25%	176.91	69.7	173.41	68.2
30%	178.00	70.1	175.01	68.9
35%	178.93	70.5	176.25	69.4
40%	179.90	70.9	177.11	69.7
45%	180.75	71.1	178.08	70.1
50%	181.58	71.5	179.04	70.5
55%	182.47	71.8	179.88	70.9
60%	183.42	72.1	180.62	71.1
65%	184.39	72.6	181.42	71.5
70%	185.45	73.0	182.55	71.8
75%	186.61	73.5	183.47	72.2
80%	187.84	73.9	184.41	72.6
85%	189.24	74.8	185.80	73.1
90%	190.97	75.2	187.48	73.8
95%	193.32	76.1	189.79	74.7

Number: 2959
 Range: 158-205 (62.2-80.7)
 Median: 181.58 (71.5)

Number: 583
 Range: 154-202 (60.6-79.5)
 Median: 179.04 (70.5)

TABLE 4

ANTERIOR ARM REACHDistribution in PercentilesAnterior Arm Reach in Centimeters and Inches

Percentiles	Cadets		Gunners	
	Cm.	Inches	Cm.	Inches
5%	83.01	32.7	81.04	31.9
10%	84.16	33.1	82.30	32.4
15%	85.15	33.5	83.50	32.9
20%	85.95	33.8	84.67	33.3
25%	86.55	34.1	85.58	33.7
30%	87.14	34.3	86.28	34.0
35%	87.75	34.5	86.86	34.2
40%	88.31	34.8	87.36	34.4
45%	88.83	35.0	87.84	34.6
50%	89.34	35.2	88.38	34.8
55%	89.82	35.4	88.96	35.0
60%	90.34	35.6	89.44	35.2
65%	90.86	35.8	89.92	35.4
70%	91.48	36.0	90.48	35.6
75%	92.14	36.3	91.08	35.9
80%	92.78	36.5	91.82	36.1
85%	93.56	36.8	92.59	36.4
90%	94.54	37.2	93.50	36.8
95%	95.93	37.8	94.88	37.4

Number: 2959
 Range: 75-103 (29.5-40.6)
 Median: 89.34 (35.2)

Number: 580
 Range: 75-99 (29.5-39.0)
 Median: 88.38 (34.8)

TABLE 5

SPAN-AKIMBODistribution in PercentilesSpan-Akimbo in Centimeters and Inches

Percentiles	Cadets		Gunners	
	Cm.	Inches	Cm.	Inches
5%	88.14	34.7	85.42	33.6
10%	89.33	35.1	87.01	34.3
15%	90.31	35.5	88.14	34.7
20%	91.14	35.9	89.06	35.1
25%	91.79	36.1	89.79	35.3
30%	92.34	36.3	90.49	35.6
35%	92.84	36.5	91.14	35.9
40%	93.29	36.7	91.66	36.1
45%	93.74	36.9	92.20	36.3
50%	94.22	37.1	92.80	36.5
55%	94.74	37.3	93.35	36.7
60%	95.25	37.5	93.88	37.0
65%	95.75	37.7	94.36	37.1
70%	96.32	37.9	94.83	37.3
75%	96.98	38.1	95.42	37.5
80%	97.72	38.5	96.07	37.8
85%	98.56	38.8	96.63	38.0
90%	99.54	39.2	97.39	38.3
95%	100.95	39.7	98.87	38.9

Number: 2956

Range: 81-108 (31.9-42.5)

Median: 94.22 (37.1)

Number: 582

Range: 79-106 (31.1-41.7)

Median: 92.80 (36.5)

TABLE 6

BIACROMIALDistribution in PercentilesBiacromial in Centimeters and Inches

Percentiles	Cadets		Gunners	
	Cm.	Inches	Cm.	Inches
5%	36.61	14.4	35.37	13.9
10%	37.30	14.7	36.13	14.2
15%	37.76	14.9	36.79	14.4
20%	38.13	15.0	37.11	14.6
25%	38.51	15.2	37.48	14.8
30%	38.77	15.3	37.80	14.9
35%	39.03	15.4	38.12	15.0
40%	39.29	15.5	38.40	15.1
45%	39.54	15.6	38.67	15.2
50%	39.79	15.7	38.93	15.3
55%	40.03	15.8	39.20	15.4
60%	40.28	15.9	39.46	15.5
65%	40.53	16.0	39.71	15.6
70%	40.80	16.0	39.96	15.7
75%	41.07	16.2	40.21	15.8
80%	41.35	16.3	40.51	15.9
85%	41.70	16.4	40.87	16.1
90%	42.19	16.6	41.24	16.2
95%	42.90	16.9	41.95	16.5

Number: 2956
 Range: 32-36 (12.6-18.1)
 Median: 39.79 (15.7)

Number: 583
 Range: 32-44 (12.6-17.3)
 Median: 38.93 (15.3)

TABLE 7

BI-DELTOIDDistribution in PercentilesBi-Deltoid in Centimeters and Inches

Percentiles	Cadets		Gunners	
	Cm.	Inches	Cm.	Inches
5%	42.50	16.7	41.88	16.5
10%	43.21	17.0	42.46	16.7
15%	43.68	17.2	42.98	16.9
20%	44.10	17.4	43.29	17.0
25%	44.40	17.5	43.60	17.2
30%	44.70	17.6	43.91	17.3
35%	45.00	17.7	44.17	17.4
40%	45.24	17.8	44.41	17.5
45%	45.48	17.9	44.66	17.6
50%	45.72	18.0	44.90	17.7
55%	45.96	18.1	45.16	17.8
60%	46.22	18.2	45.43	17.9
65%	46.50	18.3	45.70	18.0
70%	46.77	18.4	45.97	18.1
75%	47.06	18.5	46.30	18.2
80%	47.43	18.7	46.63	18.3
85%	47.79	18.8	46.97	18.5
90%	48.31	19.0	47.51	18.7
95%	49.00	19.3	48.16	19.0

Number: 2955
 Range: 39-52 (15.4-20.5)
 Median: 45.72 (18.0)

Number: 584
 Range: 39-50 (15.4-19.7)
 Median: 44.90 (17.7)

TABLE 8

CHEST BREADTHDistribution in PercentilesChest Breadth in Centimeters and Inches

Percentiles	Cadets		Gunners	
	Cm.	Inches	Cm.	Inches
5%	26.23	10.3	25.56	10.1
10%	26.78	10.5	26.20	10.3
15%	27.15	10.7	26.54	10.4
20%	27.40	10.8	26.94	10.6
25%	27.65	10.9	27.20	10.7
30%	27.90	11.0	27.43	10.8
35%	28.12	11.1	27.64	10.9
40%	28.33	11.2	27.84	11.0
45%	28.53	11.2	28.03	11.0
50%	28.75	11.3	28.21	11.1
55%	28.95	11.4	28.40	11.2
60%	29.16	11.5	28.59	11.3
65%	29.38	11.6	28.83	11.4
70%	29.60	11.7	29.09	11.4
75%	29.84	11.8	29.33	11.5
80%	30.14	11.9	29.59	11.7
85%	30.50	12.0	29.93	11.8
90%	30.88	12.2	30.29	11.9
95%	31.56	12.4	30.82	12.1

Number: 2957
 Range: 22-34 (8.7-13.4)
 Median: 28.75 (11.3)

Number: 581
 Range: 21-33 (8.3-13.0)
 Median: 28.21 (11.1)

TABLE 9

CHEST DEPTHDistribution in PercentilesChest Depth in Centimeters and Inches

Percentiles	Cadets		Gunners	
	Cm.	Inches	Cm.	Inches
5%	18.25	7.2	18.08	7.1
10%	18.83	7.4	18.73	7.4
15%	19.23	7.6	19.04	7.5
20%	19.51	7.7	19.35	7.6
25%	19.77	7.8	19.62	7.7
30%	19.98	7.9	19.86	7.8
35%	20.19	8.0	20.06	7.9
40%	20.38	8.0	20.28	8.0
45%	20.57	8.1	20.49	8.1
50%	20.76	8.2	20.69	8.2
55%	20.96	8.3	20.88	8.2
60%	21.15	8.3	21.08	8.3
65%	21.38	8.4	21.27	8.4
70%	21.60	8.5	21.46	8.5
75%	21.84	8.6	21.74	8.6
80%	22.14	8.7	22.04	8.7
85%	22.52	8.9	22.41	8.8
90%	22.94	9.0	22.87	9.0
95%	23.64	9.3	23.45	9.2

Number: 2959
 Range: 16-28 (6.3-11.0)
 Median: 20.76 (8.2)

Number: 583
 Range: 15.-27 (5.9-10.6)
 Median: 20.69 (8.2)

TABLE 10

ABDOMINAL DEPTHDistribution in PercentilesAbdominal Depth in Centimeters and Inches

Percentiles	Cadets		Gunners	
	Cm.	Inches	Cm.	Inches
5%	18.31	7.21	18.26	7.20
10%	18.94	7.46	18.79	7.40
15%	19.23	7.57	19.16	7.55
20%	19.48	7.67	19.41	7.64
25%	19.74	7.77	19.67	7.75
30%	19.99	7.87	19.93	7.87
35%	20.19	7.95	20.14	7.93
40%	20.39	8.03	20.33	8.00
45%	20.59	8.12	20.52	8.08
50%	20.79	8.18	20.71	8.15
55%	20.99	8.26	20.90	8.23
60%	21.21	8.35	21.11	8.31
65%	21.43	8.44	21.35	8.41
70%	21.65	8.52	21.58	8.52
75%	21.88	8.62	21.81	8.58
80%	22.17	8.74	22.07	8.70
85%	22.56	8.89	22.46	8.84
90%	22.95	9.05	22.86	9.00
95%	23.70	9.33	23.59	9.29

Number: 2958
 Range: 16-27 (6.3-10.6)
 Median: 20.79 (8.2)

Number: 584
 Range: 16-36 (6.3-14.2)
 Median: 20.71 (8.2)

TABLE 11

BI-ILIACDistribution in PercentilesBi-Iliac in Centimeters and Inches

Percentiles	Cadets		Gunners	
	Cm.	Inches	Cm.	Inches
5%	26.43	10.4	26.13	10.3
10%	27.06	10.7	26.58	10.5
15%	27.34	10.8	26.98	10.6
20%	27.61	10.9	27.25	10.7
25%	27.89	11.0	27.50	10.8
30%	28.12	11.1	27.76	10.9
35%	28.31	11.1	28.01	11.0
40%	28.51	11.2	28.20	11.1
45%	28.70	11.3	28.41	11.2
50%	28.89	11.4	28.60	11.3
55%	20.09	11.4	28.80	11.3
60%	29.30	11.5	28.99	11.4
65%	29.51	11.6	29.22	11.5
70%	29.72	11.7	29.45	11.6
75%	29.94	11.8	29.68	11.7
80%	30.20	11.9	29.91	11.8
85%	30.52	12.0	30.22	11.9
90%	30.84	12.2	30.63	12.0
95%	31.44	12.4	31.15	12.2

Number: 2956
 Range: 23-34 (9.1-13.4)
 Median: 28.89 (11.4)

Number: 584
 Range: 24-34 (9.4-13.4)
 Median: 28.60 (11.3)

TABLE 12

FOOT LENGTHDistribution in PercentilesFoot Length in Millimeters and Inches

Percentiles	<u>Cadets</u>		<u>Gunners</u>	
	Mm.	Inches	Mm.	Inches
5%	249.60	9.8	243.18	9.6
10%	253.63	10.0	246.36	9.7
15%	256.11	10.1	250.04	9.8
20%	258.17	10.2	252.33	9.9
25%	259.93	10.2	255.16	10.0
30%	261.60	10.3	256.72	10.1
35%	263.13	10.3	258.37	10.2
40%	264.61	10.4	260.20	10.2
45%	265.67	10.4	261.69	10.3
50%	267.19	10.5	263.33	10.4
55%	268.52	10.6	264.91	10.4
60%	269.87	10.6	266.52	10.5
65%	271.36	10.7	267.87	10.6
70%	272.98	10.7	269.54	10.6
75%	275.03	10.8	271.08	10.7
80%	276.96	10.9	273.32	10.7
85%	279.32	11.0	275.68	10.8
90%	282.31	11.1	278.85	11.0
95%	287.69	11.3	281.81	11.1

Number: 2959
 Range: 224-311 (8.8-12.2)
 Median: 267.19 (10.5)

Number: 583
 Range: 228-300 (9.0-11.8)
 Median: 263.33 (10.4)

TABLE 13

FOOT BREADTHDistribution in PercentilesFoot Breadth in Millimeters and Inches

Percentiles	Cadets		Gunners	
	Mm.	Inches	Mm.	Inches
5%	91.11	3.6	89.08	3.5
10%	92.54	3.6	91.07	3.6
15%	93.63	3.7	92.30	3.6
20%	94.57	3.7	93.18	3.7
25%	95.17	3.7	93.92	3.7
30%	95.81	3.8	94.54	3.7
35%	96.47	3.8	95.31	3.8
40%	97.10	3.8	95.96	3.8
45%	97.72	3.8	96.49	3.8
50%	98.34	3.9	97.08	3.8
55%	98.91	3.9	97.81	3.8
60%	99.49	3.9	98.50	3.9
65%	100.11	3.9	99.18	3.9
70%	100.82	4.0	99.85	3.9
75%	101.64	4.0	100.43	4.0
80%	102.57	4.0	101.16	4.0
85%	103.57	4.1	102.33	4.0
90%	104.90	4.1	103.62	4.1
95%	106.63	4.2	105.30	4.2

Number: 2959
 Range: 83-118 (3.3-4.6)
 Median: 98.34 (3.9)

Number: 584
 Range: 80-111 (3.1-4.4)
 Median: 97.08 (3.8)

TABLE 14

HEAD CIRCUMFERENCEDistribution in PercentilesHead Circumference in Centimeters and Inches

Percentiles	<u>Cadets</u>		<u>Gunners</u>	
	Cm.	Inches	Cm.	Inches
5%	54.51	22.5	53.92	21.2
10%	55.10	21.7	54.36	21.4
15%	55.36	21.8	54.74	21.5
20%	55.64	21.9	55.07	21.7
25%	55.88	22.0	55.29	21.8
30%	56.10	22.1	55.52	21.8
35%	56.30	22.2	55.75	21.9
40%	56.50	22.2	55.98	22.0
45%	56.70	22.3	56.18	22.1
50%	56.89	22.4	56.37	22.2
55%	57.08	22.5	56.57	22.3
60%	57.28	22.6	56.76	22.4
65%	57.46	22.6	56.96	22.4
70%	57.66	22.7	57.20	22.5
75%	57.85	22.8	57.45	22.6
80%	58.10	22.9	57.70	22.7
85%	58.42	23.0	57.94	22.8
90%	58.79	23.2	58.34	22.9
95%	59.37	23.4	58.85	23.2

Number: 2955
 Range: 51-62 (20.1-24.4)
 Median: 56.89 (22.4)

Number: 584
 Range: 51-60 (20.1-23.6)
 Median: 56.37 (22.2)

TABLE 15

CHEST CIRCUMFERENCE-RESTDistribution in PercentilesChest Circumference in Centimeters and Inches

Percentiles	Cadets		Gunners	
	Cm.	Inches	Cm.	Inches
5%	83.96	33.1	82.61	32.5
10%	85.37	33.6	84.05	33.1
15%	86.40	34.0	85.06	33.5
20%	87.19	34.3	85.93	33.8
25%	87.92	34.6	86.80	34.2
30%	88.61	34.9	87.53	34.5
35%	89.23	35.1	88.27	34.8
40%	89.90	35.4	88.94	35.0
45%	90.32	35.6	89.51	35.2
50%	90.70	35.7	90.05	35.4
55%	91.43	36.0	90.60	35.7
60%	92.07	36.3	91.18	35.9
65%	92.77	36.5	91.85	36.2
70%	93.53	36.8	92.53	36.4
75%	94.29	37.1	93.32	36.7
80%	95.11	37.4	94.16	37.1
85%	96.10	37.8	94.98	37.4
90%	97.48	38.4	96.13	37.8
95%	99.16	39.0	98.23	38.7

Number: 2954
 Range: 78-110 (30.7-43.3)
 Median: 90.70 (35.7)

Number: 584
 Range: 78-104 (30.7-40.9)
 Median: 90.05 (35.4)

TABLE 16

CALF CIRCUMFERENCE - LeftDistribution in PercentilesCalf Circumference in Centimeters and Inches

Percentiles	<u>Cadets</u>		<u>Gunners</u>	
	Cm.	Inches	Cm.	Inches
5%	32.64	12.8	31.72	12.5
10%	33.33	13.1	32.46	12.8
15%	33.83	13.3	33.00	13.0
20%	34.19	13.5	33.40	13.2
25%	34.49	13.6	33.74	13.3
30%	34.80	13.7	34.05	13.4
35%	35.09	13.8	34.31	13.5
40%	35.37	13.9	34.55	13.6
45%	35.65	14.0	34.79	13.7
50%	35.93	14.1	35.02	13.8
55%	36.20	14.3	35.28	13.9
60%	36.50	14.4	35.60	14.0
65%	36.78	14.5	35.96	14.2
70%	37.09	14.6	36.32	14.3
75%	37.44	14.7	36.68	14.4
80%	37.79	14.9	37.21	14.6
85%	38.23	15.0	37.46	14.7
90%	38.79	15.3	37.92	14.9
95%	39.62	15.6	38.64	15.2

Number: 2955
 Range: 28-45 (11.0-17.7)
 Median: 35.93 (14.1)

Number: 581
 Range: 29-40 (11.4-15.7)
 Median: 35.02 (13.8)

TABLE 17

SITTING HEIGHTDistribution in PercentilesSitting Height in Centimeters and Inches

Percentiles	<u>Cadets</u>		<u>Gunners</u>	
	Cm.	Inches	Cm.	Inches
5%	87.60	34.5	83.35	33.6
10%	88.60	34.9	86.75	34.2
15%	89.35	35.2	87.75	34.5
20%	90.01	35.4	88.48	34.8
25%	90.48	35.6	89.10	35.1
30%	90.96	35.8	89.59	35.2
35%	91.38	36.0	90.06	35.5
40%	91.81	36.1	90.43	35.6
45%	92.20	36.3	90.80	35.7
50%	92.55	36.4	91.18	35.9
55%	92.91	36.6	91.57	36.0
60%	93.30	36.7	91.95	36.2
65%	93.71	36.9	92.33	36.3
70%	94.15	37.0	92.71	36.5
75%	94.66	37.3	93.12	36.7
80%	95.20	37.5	93.60	36.9
85%	95.80	37.7	94.13	37.0
90%	96.57	38.0	94.82	37.3
95%	97.70	38.5	96.07	37.8

Number: 2959
 Range: 83-103 (32.7-40.6)
 Median: 92.55 (36.4)

Number: 584
 Range: 82-100 (32.3-39.4)
 Median: 91.18 (35.9)

TABLE 18

HEAD HEIGHTDistribution in PercentilesHead Height in Millimeters and Inches

Percentiles	<u>Cadets</u>		<u>Gunners</u>	
	<u>Mm.</u>	<u>Inches</u>	<u>Mm.</u>	<u>Inches</u>
5%	123.29	4.8	119.96	4.7
10%	125.43	4.9	122.09	4.8
15%	126.52	5.0	123.67	4.9
20%	127.56	5.0	124.97	4.9
25%	128.52	5.1	125.86	5.0
30%	129.21	5.1	126.75	5.0
35%	129.98	5.1	127.74	5.0
40%	130.73	5.2	128.50	5.1
45%	131.38	5.2	129.25	5.1
50%	132.22	5.2	130.23	5.1
55%	133.00	5.2	130.84	5.2
60%	133.63	5.3	131.43	5.2
65%	134.47	5.3	132.11	5.2
70%	135.21	5.3	132.87	5.2
75%	136.03	5.4	133.99	5.3
80%	136.95	5.4	134.91	5.3
85%	138.12	5.4	136.14	5.4
90%	139.42	5.5	137.58	5.4
95%	141.55	5.6	139.71	5.5

Number: 2956
 Range: 110-153 (4.3-6.0)
 Median: 132.22 (5.2)

Number: 584
 Range: 114-147 (4.5-5.8)
 Median: 130.23 (5.1)

TABLE 19

SITTING HEIGHT MINUS HEAD HEIGHTDistribution in Percentiles

Percentiles	Cadets	
	Cm.	Inches
5%	75.09	29.6
10%	75.99	29.9
15%	76.68	30.2
20%	77.27	30.4
25%	77.77	30.6
30%	78.21	30.8
35%	78.62	31.0
40%	79.03	31.1
45%	79.40	31.3
50%	79.76	31.4
55%	80.13	31.5
60%	80.51	31.7
65%	80.89	31.8
70%	81.32	32.0
75%	81.78	32.2
80%	82.30	32.4
85%	82.88	32.6
90%	83.62	32.9
95%	84.74	33.3

Number: 2955

Range: 70-90 (27.6-35.4)

Median: 79.76 (31.4)

TABLE 20

TRUNK HEIGHTDistribution in PercentilesTrunk Height in Centimeters and Inches

Percentiles	<u>Cadets</u>		<u>Gunners</u>	
	<u>Cm.</u>	<u>Inches</u>	<u>Cm.</u>	<u>Inches</u>
5%	56.44	22.2	54.70	21.5
10%	57.32	22.6	55.78	22.0
15%	57.85	22.8	56.48	22.2
20%	58.30	23.0	56.94	22.4
25%	58.72	23.1	57.40	22.6
30%	59.08	23.3	57.78	22.7
35%	59.42	23.4	58.15	22.9
40%	59.73	23.5	58.50	23.0
45%	60.02	23.6	58.83	23.2
50%	60.33	23.8	59.14	23.3
55%	60.64	23.9	59.44	23.4
60%	60.95	24.0	59.74	23.5
65%	61.27	24.1	60.05	23.6
70%	61.63	24.3	60.35	23.8
75%	62.02	24.4	60.65	23.9
80%	62.42	24.6	60.97	24.0
85%	62.92	24.8	61.52	24.2
90%	63.48	25.0	62.18	24.5
95%	64.39	25.3	63.01	24.8

Number: 2957

Range: 50-69 (19.7-27.2)

Median: 60.33 (23.8)

Number: 583

Range: 51-66 (20.1-26.0)

Median: 59.14 (23.3)

TABLE 21

BUTTOCK-KNEEDistribution in PercentilesButtock Knee in Centimeters and Inches

Percentiles	Cadets		Gunners	
	Cm.	Inches	Cm.	Inches
5%	55.92	22.0	53.72	21.1
10%	56.81	22.4	54.92	21.6
15%	57.38	22.6	55.83	22.0
20%	57.87	22.8	56.11	22.2
25%	58.25	22.9	56.92	22.4
30%	58.60	23.1	57.35	22.6
35%	58.95	23.2	57.77	22.7
40%	59.28	23.3	58.14	22.9
45%	59.60	23.5	58.46	23.0
50%	59.93	23.6	58.77	23.1
55%	60.25	23.7	59.10	23.3
60%	60.57	23.8	59.45	23.4
65%	60.89	24.0	59.81	23.5
70%	61.28	24.1	60.16	23.7
75%	61.70	24.3	60.51	23.8
80%	62.14	24.4	60.86	24.0
85%	62.66	24.7	61.42	24.2
90%	63.32	24.9	62.11	24.4
95%	64.45	25.6	62.81	24.7

Number: 2954
 Range: 49-70 (19.3-27.6)
 Median: 59.93 (23.6)

Number: 582
 Range: 51-65 (20.1-25.6)
 Median: 58.77 (23.1)

TABLE 22

PATELLA HEIGHT - from floorDistribution in PercentilesPatella Height in Centimeters and Inches

Percentiles	Cadets		Gunners	
	Cm.	Inches	Cm.	Inches
5%	51.92	20.4	50.22	19.8
10%	52.72	20.7	51.09	20.1
15%	53.30	21.0	51.70	20.4
20%	53.73	21.2	52.23	20.6
25%	54.19	21.3	52.84	20.8
30%	54.54	21.5	53.25	21.0
35%	54.90	21.6	53.61	21.1
40%	55.21	21.7	53.96	21.2
45%	55.51	21.8	54.29	21.4
50%	55.81	22.0	54.60	21.5
55%	56.11	22.1	54.92	21.6
60%	56.42	22.2	55.24	21.7
65%	56.73	22.3	55.57	21.8
70%	57.05	22.5	55.90	22.0
75%	57.47	22.6	56.25	22.1
80%	57.88	22.8	56.62	22.3
85%	58.39	23.0	56.98	22.4
90%	58.94	23.2	57.55	22.6
95%	59.92	23.6	58.52	23.0

Number: 2959
 Range: 46-65 (18.1-25.6)
 Median: 55.81 (22.0)

Number: 583
 Range: 45-62 (17.7-24.4)
 Median: 54.60 (21.5)

TABLE 23

BI-EPICONDYLAR - ELBOWSDistribution in PercentilesBi-Epicondylar in Centimeters and Inches

Percentiles	Cadets		Gunners	
	Cm.	Inches	Cm.	Inches
5%	38.33	15.1	37.24	14.6
10%	39.20	15.4	38.28	15.1
15%	39.82	15.7	38.92	15.3
20%	40.29	15.9	39.42	15.5
25%	40.71	16.0	39.90	15.7
30%	41.10	16.2	40.29	15.9
35%	41.43	16.3	40.65	16.0
40%	41.77	16.4	41.01	16.2
45%	42.10	16.6	41.31	16.3
50%	42.40	16.7	41.61	16.4
55%	42.70	16.8	41.91	16.5
60%	43.00	16.9	42.31	16.6
65%	43.38	17.1	42.75	16.8
70%	43.76	17.2	43.17	17.0
75%	44.18	17.4	43.57	17.2
80%	44.65	17.6	43.96	17.3
85%	45.16	17.8	44.55	17.5
90%	45.80	18.0	45.24	17.8
95%	46.72	18.4	46.30	18.2

Number: 2955
 Range: 32-54 (12.6-21.3)
 Median: 42.40 (16.7)

Number: 584
 Range: 33-54 (13.0-21.3)
 Median: 41.61 (16.4)

TABLE 24

BI-TROCHANTERICDistribution in PercentilesBi-Trochanteric in Centimeters and Inches

Percentiles	Cadets		Gunners	
	Cm.	Inches	Cm.	Inches
5%	33.21	13.1	32.25	12.7
10%	33.83	13.3	32.80	12.9
15%	34.24	13.5	33.20	13.1
20%	34.56	13.6	33.51	13.2
25%	34.88	13.7	33.82	13.3
30%	35.14	13.8	34.11	13.4
35%	35.36	13.9	34.35	13.5
40%	35.58	14.0	34.59	13.6
45%	35.80	14.1	34.84	13.7
50%	36.03	14.2	35.09	13.8
55%	36.29	14.3	35.36	13.9
60%	36.55	14.4	35.63	14.0
65%	36.81	14.5	35.90	14.1
70%	37.10	14.6	36.19	14.2
75%	37.44	14.7	36.50	14.4
80%	37.78	14.9	36.81	14.5
85%	38.18	15.0	36.18	14.6
90%	38.68	15.2	37.65	14.8
95%	39.41	15.5	38.26	15.1

Number: 2954
 Range: 30-47 (11.8-18.5)
 Median: 36.03 (14.02)

Number: 583
 Range: 31-42 (12.2-16.5)
 Median: 35.09 (13.8)

TABLE 25

BI-EPICONDYLAR FEMORAL - KneesDistribution in PercentilesBi-Epicondylar Femoral in Centimeters and Inches

Percentiles	Cadets		Gunners	
	Cm.	Inches	Cm.	Inches
5%	18.10	7.1	17.65	6.9
10%	18.34	7.2	18.07	7.1
15%	18.57	7.3	18.24	7.2
20%	18.82	7.4	18.40	7.2
25%	19.03	7.5	18.56	7.3
30%	19.15	7.5	18.73	7.4
35%	19.27	7.6	18.90	7.4
40%	19.39	7.6	19.04	7.5
45%	19.50	7.7	19.16	7.6
50%	19.62	7.7	19.28	7.6
55%	19.74	7.8	19.40	7.6
60%	19.86	7.8	19.52	7.7
65%	19.98	7.9	19.64	7.7
70%	20.16	7.9	19.75	7.8
75%	20.35	8.0	19.87	7.8
80%	20.54	8.1	20.04	7.9
85%	20.75	8.2	20.28	8.0
90%	20.92	8.2	20.59	8.1
95%	21.42	8.4	20.89	8.2

Number: 2955
 Range: 16-29 (6.3-11.4)
 Median: 19.62 (7.7)

Number: 581
 Range: 16-22 (6.3-8.7)
 Median: 19.28 (7.6)

TABLE 26

SHOULDER-ELBOW HEIGHTDistribution in PercentilesShoulder-Elbow Height in Centimeters and Inches

Percentiles	Cadets		Gunners	
	Cm.	Inches	Cm.	Inches
5%	34.56	13.6	33.76	13.3
10%	35.19	13.8	34.40	13.5
15%	35.57	14.0	34.89	13.7
20%	35.96	14.2	35.26	13.9
25%	36.21	14.3	35.61	14.0
30%	36.44	14.3	35.95	14.1
35%	36.68	14.4	36.19	14.2
40%	36.91	14.5	36.41	14.3
45%	37.13	14.6	36.64	14.4
50%	37.34	14.7	36.86	14.5
55%	37.54	14.8	37.09	14.6
60%	37.75	14.9	37.32	14.7
65%	37.95	14.9	37.56	14.8
70%	38.22	15.0	37.80	14.9
75%	38.51	15.2	38.05	15.0
80%	38.80	15.3	38.38	15.1
85%	39.16	15.4	38.70	15.2
90%	39.63	15.6	39.06	15.4
95%	40.26	15.8	39.74	15.6

Number: 2955
 Range: 27-43 (10.6-16.9)
 Median: 37.34 (14.7)

Number: 583
 Range: 31-42 (12.2-16.5)
 Median: 36.86 (14.5)

TABLE 27

HAND LENGTHDistribution in PercentilesHand Length in Millimeters and Inches

Percentiles	<u>Cadets</u>		<u>Gunners</u>	
	mm.	Inches	mm.	Inches
5%	179.40	7.1	175.94	6.9
10%	182.43	7.2	180.23	7.1
15%	184.49	7.3	181.97	7.2
20%	186.16	7.3	183.60	7.2
25%	187.48	7.4	185.11	7.3
30%	188.61	7.4	186.59	7.3
35%	189.79	7.5	187.57	7.4
40%	190.82	7.5	188.91	7.4
45%	191.84	7.6	190.05	7.5
50%	192.82	7.6	191.29	7.5
55%	193.96	7.6	192.40	7.6
60%	194.87	7.7	193.35	7.6
65%	196.07	7.7	194.62	7.7
70%	197.18	7.8	196.08	7.7
75%	198.35	7.8	197.35	7.8
80%	199.88	7.9	198.76	7.8
85%	201.52	7.9	200.59	7.9
90%	203.95	8.0	202.29	8.0
95%	207.33	8.2	205.69	8.1

Number: 2952
 Range: 163-223 (6.4-8.8)
 Median: 192.82 (7.6)

Number: 582
 Range: 160-220 (6.3-8.7)
 Median: 191.29 (7.5)

TABLE 28

HAND BREADTHDistribution in PercentilesHand Breadth in Millimeters and Inches

Percentiles	<u>Cadets</u>		<u>Gunners</u>	
	Mm.	Inches	Mm.	Inches
5%	79.69	3.1	78.87	3.1
10%	80.57	3.2	80.18	3.2
15%	81.91	3.2	81.36	3.2
20%	82.78	3.3	82.26	3.2
25%	83.48	3.3	83.24	3.3
30%	84.02	3.3	83.74	3.3
35%	84.53	3.3	84.29	3.3
40%	85.06	3.4	84.82	3.3
45%	85.60	3.4	85.26	3.4
50%	86.14	3.4	85.69	3.4
55%	86.65	3.4	86.16	3.4
60%	87.17	3.4	86.67	3.4
65%	87.79	3.5	87.16	3.4
70%	88.46	3.5	87.73	3.5
75%	89.09	3.5	88.42	3.5
80%	89.86	3.5	89.17	3.5
85%	90.73	3.6	89.92	3.5
90%	91.91	3.6	90.90	3.6
95%	93.47	3.7	92.23	3.6

Number: 2955
 Range: 73-104 (2.9-4.1)
 Median: 86.14 (3.4)

Number: 582
 Range: 72-98 (2.8-3.9)
 Median: 85.69 (3.4)

TABULAR INCONSISTENCIES

In comparing percentile distributions and correlation tables, some small and occasional inconsistencies may be noted in frequencies and totals. These are due to the following factors:

a. Occasional mechanical lapses of the card counter resulting in one or two misplaced cases. These have not been corrected since they are too few to influence results, and since each correlation requires nearly one-half day of work with the sorter and card counter.

b. Cases in which one of the variables in the correlation or index is absent from the original data.

c. Cases in which the correlation scattergram revealed an error in measuring or recording the dimension, resulting in the case being thrown out subsequent to the compilation of the distribution table.

CORRELATIONS

The correlation scattergrams and summary tables show the relations of stature weight, and sitting height to various dimensions of interest for turret accommodation. For instance, enter any table at a given stature class and you may see what is the range of buttock-knee length found in each value of buttock-knee. These correlations are designed to avoid the necessity of considering for each individual all of the different turret dimensions. No coefficients or correlations have been calculated, since the entries in the cells are the significant items - not so much the general measure of relationship.

They also show, by the absence of close correlation, which bodily dimensions have to be checked for turret accommodation, irrespective of the stature, weight, or sitting height. It may be found necessary to calculate many more such correlations as new spatial problems may arise.

The reason for selecting stature, weight, and sitting height as general measurements for correlating with other body segments was, initially, the hope that these very well-known and commonly taken dimensions might be sufficiently closely associated with some of the measurements particularly devised for turret accommodation as to enable the selection of men for a specified turret size to be made without the application of "trick measurements". Thus, stature, weight, and sitting height were correlated with all the apposite measurements. Fortunately, it has proved to be the case that most of the important measurements for this purpose can be fairly well predicted from stature and weight.

Then certain measurements of putatively great importance in the turret problem were further inter-correlated with other measurements. This selected list included patella height, buttock-knee, bi-trochanteric, anterior arm reach, bi-deltoid, abdominal depth and bi-epicondylar (elbows), squatting diagonal, foot length (with patella height only), and truck height with chest circumference. These measurements were correlated with each other. These correlations were abandoned respectively when it became evident that the law of diminishing returns was operating. Comments on the individual scattergrams reveal the utility, or lack of it, of these various inter-correlations.

SCHEMATIC GUIDE TO CORRELATIONS OF PRINCIPAL MEASUREMENTS

	Stature	Weight	Squatting Diagonal	Anterior Arm Reach	Shoulder-Elbow Height	Span-Akimbo	Bi-deltoid	Sitting Height	Bi-epicondylar (elbows)	Abdominal Depth	Bi-trochanteric	Buttock-knee	Patella Height	Leg Length (subtractive)
Stature	*	0	0	0	0	0	0	0	0	0	0	0	0	0
Weight	0	*	0	0	0	0	0	0	0	0	0	0	0	0
Squatting Diagonal	0	0	*	0	0	0	0	0	0	0	0	0	0	0
Anterior Arm Reach	0	0	0	*	0	0	0	0	0	0	0	0	0	0
Shoulder-Elbow Height	0	0	0	0	*	0	0	0	0	0	0	0	0	0
Span-Akimbo	0	0	0	0	0	*	0	0	0	0	0	0	0	0
Bi-deltoid	0	0	0	0	0	0	*	0	0	0	0	0	0	0
Sitting Height	0	0	0	0	0	0	0	*	0	0	0	0	0	0
Bi-epicondylar (elbows)	0	0	0	0	0	0	0	0	*	0	0	0	0	0
Abdominal Depth	0	0	0	0	0	0	0	0	0	*	0	0	0	0
Bi-trochanteric	0	0	0	0	0	0	0	0	0	0	*	0	0	0
Buttock-knee	0	0	0	0	0	0	0	0	0	0	0	*	0	0
Patella Height	0	0	0	0	0	0	0	0	0	0	0	0	*	0
Leg Length (subtractive)	0	0	0	0	0	0	0	0	0	0	0	0	0	*

* denotes utilizable correlation
 0 denotes low, useless correlation
 . denotes correlation not attempted

GENERAL COMMENTS ON CORRELATIONS

The correlations to be discussed have been attempted only for the Aviation Cadet series, and not for the gunners.

Stature. Of twelve correlations involving stature, seven are high enough to be utilizable, whereas five show little relationship. The seven useful correlations of stature are with weight, sitting height, buttock-knee, patella height (all components of stature); and anterior arm reach, span-akimbo, and shoulder-elbow. The five of no utility are of stature with bi-deltoid, abdominal depth, bi-epicondylar (elbows), bi-trochanteric, and squatting diagonal.

In general, bodily lengths are predictable from stature, breadths are not.

Weight. Of eleven correlations based on weight, only three have predictive value: These are of weight with bi-deltoid, bi-epicondylar (elbows), and bi-trochanteric (all breadth dimensions). Though weight is roughly determined by stature, knowledge of weight will not help determine values for the long bodily dimensions (sitting height, buttock-knee, patella height); the arm segments (anterior arm reach, span-akimbo, and shoulder elbow); the erratic squatting diagonal; or abdominal depth.

Generally, bodily breadths are predictable from weight; lengths are not. The combined use of stature and weight permits reasonable prediction of all measurements mentioned except squatting diagonal and abdominal depth.

Sitting Height. This dimension is usefully correlated with only two of eleven other dimensions: patella height and squatting diagonal.

Span-akimbo. This dimension correlates usefully with two other arm dimensions, anterior arm reach and shoulder-elbow; and with two leg lengths, patella height and buttock-knee.

Patella Height. It can be predicted, as noted above, from stature, sitting height and span-akimbo, while it will permit predictions of buttock-knee and foot length.

Unpredictable Traits. In general, abdominal depth, bi-deltoid, and squatting diagonal vary erratically and cannot be predicted from or permit prediction of other dimensions. (Squatting diagonal can be roughly approximated if sitting height is known.) When crucial, they must be measured directly.

The correlations are summarized on the following graph, while the individual scattergrams have comments appended.

SCATTER DIAGRAM 1

CORRELATION OF WEIGHT WITH STATURE

Weight (pounds)	Frequency		Median <u>175.67</u> (69.2)
	2	1	
206-211	2	1	
200-205			
194-199	3		
188-193	10		
182-187	22		
176-181	53		
170-175	52		
164-169	69		
158-163	75		
152-157	107		
146-151	86		
140-145	61		
134-139	64		
128-133	28		
122-127	2		
116-121	2		
110-115	3		

	1	4	5	15	21	24	31	27	34	29	21	12	2	1
	11	15	21	26	39	49	53	57	39	34	13	1		
	1	4	5	10	15	7	18	8	12	2	1			
	2	3	7	3	6	5	4	6	3	3				
	1	1	1											
	2													

	2	3	7	3	6	5	4	6	3	3				
	186	188	189	191	192	194	197							
	183	185	180	182	177	179	182	185	180	177	174	176	179	180
	195	197	192	194	192	194	197	195	192	192	195	192	194	197

Stature	Frequency	
	2	1
61.4	2	
62.5	1	
62.6	2	
63.7	2	
63.8	6	
64.9	3	
65.0	3	
66.0	8	
67.2	19	
67.3	32	
68.4	64	
68.5	69	
69.6	75	
70.8	80	
70.9	86	
71.9	107	
72.0	107	
73.1	121	
73.2	121	
74.4	134	
75.5	134	
75.6	134	
76.7	134	
76.8	134	
77.9	134	
78.0	134	
78.2	134	

There is a gradual increase of weight with increased stature. Prediction is better toward the extremes, since the middle ranges of stature include individuals with almost the entire range of weight.

SCATTER DIAGRAM 4

CORRELATION OF SITTING HEIGHT WITH STATURE

Sitting Height		Median										Stature						
Cm.	Inches	1	2	3	6	15	3	13	41	180	177	174	183	186	189	192	195	198
103	40.6-40.9	1						1	3	180	177	174	183	186	189	192	195	198
101-102	40.0-40.5	1						13	41	180	177	174	183	186	189	192	195	198
99-100	39.0-39.9	7						49	115	182	179	176	185	188	191	194	197	
97-98	38.2-38.9	36	2	3	6	15	103	100	131	182	179	176	185	188	191	194	197	
95-96	37.4-38.1	29	19	22	52	103	209	50	63	182	179	176	185	188	191	194	197	
93-94	36.6-37.3	12	95	69	171	149	40	12	6	182	179	176	185	188	191	194	197	
91-92	35.8-36.5	1	154	89	157	96	2	1		182	179	176	185	188	191	194	197	
89-90	35.0-35.7	1	10	20	45	18				182	179	176	185	188	191	194	197	
87-88	34.3-34.9	1	6	15	5	1				182	179	176	185	188	191	194	197	
85-86	33.5-34.2	1	1	5	1					182	179	176	185	188	191	194	197	
83-84	32.7-33.4	1	1	5	1					182	179	176	185	188	191	194	197	
<u>Cm.</u>		156	159	162	165	168	171	174	180	180	177	174	183	186	189	192	195	198
		158	161	164	167	170	173	176	182	182	179	176	185	188	191	194	197	
<u>Inches</u>		61.4	62.6	63.8	65.0	66.1	67.3	68.5	70.9	70.9	69.7	68.5	72.0	73.2	74.4	75.6	76.8	78.0
		62.5	63.7	64.9	66.0	67.2	68.4	69.6	71.9	71.9	70.8	69.6	73.1	74.3	75.5	76.7	77.9	78.2

Median
92.55 (36.4)

A very close correlation, expected since sitting height is a component of stature.

SCATTER DIAGRAM 6

CORRELATION OF PATELLA HEIGHT WITH STATURE

Patella Height	Median											Median				
Cm.	Inches															
61-65	25.2-25.9	1										3	7	3	1	1
62-63	24.4-25.1											35	27	43	1	1
60-61	23.6-24.3											43	6	6		
58-59	22.8-23.5											52	1			
56-57	22.0-22.7											134				
54-55	21.3-21.9											37				
52-53	20.5-21.2											176				
50-51	19.7-20.4											21				
48-49	18.9-19.6											21				
46-47	18.1-18.8											6				
																55.81 (22.0)

Cm.	156	159	162	165	168	171	174	177	180	183	186	189	192	195	198
Inches	61.4	62.6	63.8	65.0	66.1	67.3	68.5	69.7	70.9	72.0	73.2	74.4	75.6	76.8	78.0
	158	160	164	167	170	173	176	179	182	185	188	191	194	197	
	62.5	63.7	64.9	66.0	67.2	68.4	69.6	70.8	71.9	73.1	74.3	75.5	76.7	77.9	78.2

Stature

Very close correlation.

SCATTER DIAGRAM 7

CORRELATION OF SHOULDER-ELBOW HEIGHT WITH STATURE

Shoulder-Elbow Height

<u>Cm.</u>	<u>Inches</u>											<u>Median</u> 175.67 (69.2)
43	16.9											1
42	16.5											6
41	16.1											10
40	15.7									4		10
39	15.4								6			2
38	15.0								37			10
37	14.6								89			10
36	14.2								119			12
35	13.8								78			1
34	13.4								24			1
33	13.0								3			1
32	12.6								5			1
31	12.2								2			1

<u>Cm.</u>	<u>Inches</u>	156	159	162	165	168	171	174	177	180	183	186	189	192	195	198
	61.4															
	62.5															
	63.7															
	64.9															
	66.0															
	67.2															
	68.4															
	69.6															
	70.8															
	71.9															
	72.0															
	73.1															
	73.2															
	74.4															
	75.5															
	76.7															
	76.8															
	78.0															

Stature

A very close correlation, lowest in very tall men.

SCATTER DIAGRAM 8

CORRELATION OF BI-DELTOID WITH WEIGHT

Bi-Deltoid Cm. Inches	1	2	1	10	49	104	136	110	42	11	5	1	2	8	36	87	80	44	13	1	2	1	3	21	44	66	50	22	5	164	169	170	175	176	182	188	194	200	206						
	1	2	1	10	49	104	136	110	42	11	5	1	2	8	36	87	80	44	13	1	2	1	3	21	44	66	50	22	5	164	169	170	175	176	182	188	194	200	206						
	1	2	1	10	49	104	136	110	42	11	5	1	2	8	36	87	80	44	13	1	2	1	3	21	44	66	50	22	5	164	169	170	175	176	182	188	194	200	206						
	1	2	1	10	49	104	136	110	42	11	5	1	2	8	36	87	80	44	13	1	2	1	3	21	44	66	50	22	5	164	169	170	175	176	182	188	194	200	206						
Weight	110	115	116	121	122	127	128	134	139	145	140	146	151	157	163	169	170	175	181	187	193	199	205	211	211	205	200	194	188	187	181	176	170	164	158	152	146	139	134	128	122	116	110	115	
	1	1	1	1	1	1	1	1	1	1	1	1	1	1	1	1	1	1	1	1	1	1	1	1	1	1	1	1	1	1	1	1	1	1	1	1	1	1	1	1	1	1	1	1	1
Median	153.12																																												
Median	45.72																																												
	(16.0)																																												

The correlation is moderate, with the exception of very heavy men. The wide bi-deltoid variability in most weight classes limits predictability.

SCATTER DIAGRAM 11

CORRELATION OF PATELLA HEIGHT WITH SITTING HEIGHT

Patella Height	Median											
Cm.	Inches	83	85	87	89	91	93	95	97	99	101	103
64-65	25.2-25.9							1	6	1	1	
62-63	24.4-25.1				4	14	3	4	20	11	2	
60-61	23.6-24.3				22	76	27	36	57	14	4	2
58-59	22.8-23.5		5	37	110	229	122	114	60	14	2	
56-57	22.0-22.7		4	92	214	265	224	155	20	12	2	
54-55	21.3-21.9	3	19	102	139	148	212	85	20	2	1	
52-53	20.5-21.2	7	26	42	43	29	55	24	4			
50-51	19.7-20.4	1	15	6	4	1	7	2				
48-49	18.9-19.6	2	2									
46-47	18.1-18.8			1								
Median												
<u>92.55</u>												
(36.4)												
<u>55.81</u> (22.0)												

283.

Sitting Height

This correlation is close enough to be useful.

SCATTER DIAGRAM 13

CORRELATION OF ANTERIOR ARM REACH WITH SPAN-AKIMBO

Anterior Arm Reach	Median																					
Cm.	94.22 (37.1)																					
Inches	(37.1)																					
102-104											1											1
99-101											12											1
96-98											42											1
93-95											104											1
90-92											156											2
87-89											240											17
84-86											118											5
81-83											38											Median
78-80											42											89.34 (35.2)
75-77											6											

81	84	87	90	93	96	99	102	105	108
83	86	89	92	95	98	101	104	107	
31.9	33.1	34.3	35.4	36.6	37.8	39.0	40.2	41.3	42.6
33.0	34.2	35.3	36.5	37.7	38.9	40.1	41.2	42.5	42.8

Span-Akimbo

This correlation is as close as would be expected from the involvement of the upper arm segment in each measurement.

SCATTER DIAGRAM 14

CORRELATION OF PATELLA HEIGHT WITH SPAN AKIMBO

Patella Height	Median									
<u>Cm.</u>										
Inches										
61-65	25.2-25.9									
62-63	24.4-25.1									
60-61	23.6-24.3									
58-59	22.8-23.5									
56-57	22.0-22.7									
54-55	21.3-21.9	8	16	17	7	26	4	2	7	1
52-53	20.5-21.2	14	74	118	83	147	55	2	27	1
50-51	19.7-20.4	23	172	310	334	274	142	2	22	1
48-49	18.9-19.6	5	66	209	380	125	76	1	15	1
46-47	18.1-18.8	1	5	37	94	15	11			
					8					
					2					
<u>Cm.</u>										
Inches										
81	84	87	90	93	96	99	102	105	108	
83	86	89	92	95	98	101	104	108		
	31.9	33.1	34.3	35.4	36.6	37.8	39.0	40.2	41.3	42.6
	33.0	34.2	35.3	36.5	37.7	38.9	40.1	41.2	42.5	42.8

Median
55.81 (22.0)

Span-Akimbo

A valuable and close inter-relationship.

SCATTER DIAGRAM 15

CORRELATION OF SHOULDER-ELBOW HEIGHT WITH SPAN-AKIMBO

Shoulder-Elbow Height		Median									
Cm.	Inches	1	2	3	4	5	6	7	8	9	10
43	16.9-17.2										1
42	16.5-16.8										2
41	16.1-16.4										1
40	15.7-16.0										
39	15.4-15.6			3							
38	15.0-15.3		2	24							
37	14.6-14.9		13	173							
36	14.2-14.1		47	423							
35	13.8-14.7		148	242							
34	13.4-13.7		113	41							
33	13.0-13.3		20	37							
32	12.6-12.9		2								
31	12.2-12.5		1								
Cm.		81	84	87	90	93	96	99	102	105	108
		83	86	89	92	95	98	101	104	107	
Inches		31.9	33.1	34.3	35.4	36.6	37.8	39.0	40.2	41.3	42.6
		33.0	34.2	35.3	36.5	37.7	38.9	40.1	41.2	42.5	42.8

Median
37.34 (14.7)

Median
94.22
(37.1)

Span-Akimbo

A close and utilizable correlation, as expected from the involvement of the upper arm segment in each measurement.

SCATTER DIAGRAM 17
CORRELATION OF FOOT LENGTH WITH PATELLA HEIGHT

Foot Length		Median				Median				
		55.81 (22.0)				267.03 (10.5)				
Cm.	Inches	1	2	3	1	2	3	4	1	2
310-319	12.2-12.5				3	35	20		1	9
300-309	11.8-12.1					138	105		3	31
290-299	11.4-11.7					156	350		4	41
280-289	11.0-11.3					67	287		2	26
270-279	10.6-10.9					11	64			8
260-269	10.2-10.5					22	4			2
250-259	9.8-10.1					2	2			
240-249	9.4-9.7					1	1			
230-239	9.1-9.3					1	2			
220-229	8.7-9.0									
<u>Cm.</u>		46	48	50	52	54	56	58	60	62
		47	49	51	53	55	57	59	61	63
<u>Inches</u>		18.1	18.9	19.7	20.5	21.3	22.0	22.8	23.6	24.4
		18.8	19.6	20.4	21.2	21.9	22.7	23.5	24.3	25.1
										25.2
										25.9

Patella Height

A close correlation.

4. TECHNIQUES OF FEMALE MEASUREMENTS

(Except for those described below, techniques of measurement are the same as for males).

1. Chest Circumference: Maximum circumference over breasts.
2. Waist Circumference: Minimum circumference around waist.
3. Hip Circumference: Maximum circumference around buttocks.
4. Shoulder Height: Subject sitting erect, with thighs horizontal. Height from surface on which subject sits to a point on shoulder midway between the angle of shoulder and arm and angle of shoulder and neck.
5. Waist Height: Height from floor to natural waistline.
6. Eye Height: Subject sitting as for sitting height; height from seat to pupil of eye.

Body Measurements of Female Flying Personnel

Table 1

Weight

Pounds	Women Pilots AAFTD		Flying Nurses AAFSAE	
	No. of Cases	%	No. of Cases	%
96-99	1	0.2	1	0.7
100-103	7	1.6		
104-107	25	5.6	10	6.7
108-111	20	4.5	12	8.0
112-115	37	8.3	27	18.0
116-119	28	6.3	14	9.3
120-123	51	11.4	18	12.0
124-127	58	13.0	28	18.7
128-131	49	11.0	14	9.3
132-135	59	13.2	19	12.7
136-139	25	5.6	3	2.0
140-143	22	5.0	3	2.0
144-147	18	4.0		
148-151	15	3.4	1	0.7
152-155	14	3.1		
156-159	2	0.4		
160-163	7	1.6		
164-167	3	0.7		
168-171	4	0.9		
172-175	1	0.2		
Total	446		150	
Mean	128.6 pounds		121.9 pounds	
Range	96-175 pounds		96-148 pounds	

Table 2

Stature

Stature in Centimeters	Women Pilots AAFTD		Flying Nurses AAFSAE	
	No. of Cases	%	No. of	%
146-147.9			1	0.7
148-149.9			1	0.7
150-151.9	1	0.2	3	2.0
152-153.9	2	0.4	7	4.6
154-155.9	9	2.0	15	9.9
156-157.9	35	7.8	16	10.5
158-159.9	37	8.3	17	11.2
160-161.9	54	12.1	25	16.4
162-163.9	58	13.0	18	11.8
164-165.9	60	13.4	23	15.1
166-167.9	81	18.1	12	7.9
168-169.9	42	9.4	5	3.3
170-171.9	24	5.4	2	1.3
172-173.9	27	6.0	5	3.3
174-175.9	9	2.0	1	0.7
176-177.9	4	0.9	1	0.7
178-179.9	2	0.4		
180-181.9	1	0.2		
182-183.9				
184-185.9	1	0.2		
Total	447		152	
Mean	164.8 cm. (64.9 inches)		161.3 cm. (63.5 inches)	
Range	150-184 cm. (58.0-72.5 inches)		147-176 cm. (57.9-69.4 inches)	

Table 3

Biacromial

Centimeters	Women Pilots AAFFTD		Flying Nurses AAFSAE	
	No. of Cases	%	No. of Cases	%
29.0-29.3				
29.4-29.7			2	1.3
29.8-30.1	2	0.4	2	1.3
30.2-30.5				
30.6-30.9	2	0.4	4	2.6
31.0-31.3	2	0.4	5	3.3
31.4-31.7	4	0.9	1	0.7
31.8-32.1	12	2.7	8	5.3
32.2-32.5	9	2.0	10	6.6
32.6-32.9	27	6.0	7	4.6
33.0-33.3	19	4.2	7	4.6
33.4-33.7	36	8.0	15	9.9
33.8-34.1	34	7.6	20	13.2
34.2-34.5	35	7.8	14	9.2
34.6-34.9	37	8.3	18	11.8
35.0-35.3	32	7.2	15	9.9
35.4-35.7	44	9.8	5	3.3
35.8-36.1	30	6.7	5	3.3
36.2-36.5	33	7.4	5	3.3
36.6-36.9	34	7.6	2	1.3
37.0-37.3	16	3.6	4	2.6
37.4-37.7	13	2.9	3	2.0
37.8-38.1	16	3.6		
38.2-38.5	3	0.7		
38.6-38.9	4	0.9		
39.0-39.3	1	0.2		
39.4-39.7	1	0.2		
Total	447		152	
Mean	34.96 cm. (13.76 inches)		33.99 cm. (13.38 inches)	
Range	29.8-39.7 cm. (11.7-15.6 inches)		29.4-37.7 cm. (11.6-14.8 inches)	

Table 4
Foot Length

Millimeters	Women Pilots AAFFTD		Flying Nurses AAFSAE	
	No. of Cases	%	No. of Cases	%
208-211	1	0.2		
212-215	1	0.2		
216-219	3	0.7	1	0.7
220-223	7	1.6	4	2.6
224-227	16	3.7	8	5.3
228-231	37	8.3	14	9.2
232-235	59	13.3	10	6.6
236-239	55	12.4	28	18.4
240-243	67	15.0	19	12.5
244-247	58	13.0	19	12.5
248-251	50	11.2	22	14.5
252-255	38	8.5	11	7.2
256-259	31	7.0	8	5.3
260-263	13	2.9	6	3.9
264-267	5	1.1	1	0.7
268-271	2	0.4	1	0.7
272-275	1	0.2		
276-279	1	0.2		
Total	445		152	
Mean	243.0 mm. (9.57 inches)		242.6 mm. (9.55 inches)	
Range	208-276 mm. (8.9-10.9 inches)		216-268 mm. (8.5-10.6 inches)	

Table 5

Foot Breadth

Millimeters	Women Pilots AAFFTD		Flying Nurses AAFSAE	
	No. of Cases	%	No. of Cases	%
76-79	1	0.2		
80-83	18	4.0	7	4.6
84-87	63	14.1	29	19.1
88-91	159	35.6	44	28.9
92-95	128	28.6	49	32.2
96-99	63	14.1	17	11.2
100-103	11	2.5	6	3.9
104-107	3	0.7		
108-111	1	0.2		
Total	447		152	
Mean	91.81 mm. (3.61 inches)		91.53 mm. (3.60 inches)	
Range	76-111 mm. (2.99-4.37 inches)		80-103 mm. (3.15-4.06 inches)	

4/11/78

Table 6

Chest Circumference

Inches	Women Pilots AAFFTD		Flying Nurses AAFSAE	
	No. of Cases	%	No. of Cases	%
29-29.9	2	0.4		
30-30.9	9	2.0	2	1.3
31-31.9	18	4.0	10	6.6
32-32.9	48	10.7	26	17.1
33-33.9	67	15.0	37	24.3
34-34.9	93	20.8	30	19.7
35-35.9	80	17.9	27	17.8
36-36.9	59	13.2	8	5.3
37-37.9	32	17.2	9	5.9
38-38.9	23	5.2	3	2.0
39-39.9	9	2.0		
40-40.9	5	1.1		
41-41.9	1	0.2		
42-42.9	1	0.2		
Total	447		152	
Mean	34.98 inches		34.20 inches	
Range	29.0-42.9 inches		30.0-38.9 inches	

Table 7.

Waist Circumference

Inches	Women Pilots AAFFTD		Flying Nurses AAFSAE	
	No. of Cases	%	No. of Cases	%
22-22.9	5	1.2		
23-23.9	33	7.4	9	5.9
24-24.9	67	15.0	31	20.4
25-25.9	113	25.3	37	24.3
26-26.9	87	19.5	35	23.0
27-27.9	62	13.9	28	18.4
28-28.9	42	9.4	5	3.3
29-29.9	20	4.5	4	2.6
30-30.9	3	1.8	1	0.7
31-31.9	8	1.8		
32-32.9	1	0.2	1	0.7
33-33.9	1	0.2		
34-34.9				
35-35.9			1	0.7
Total	447		152	
Mean	26.33 inches		26.12 inches	
Range	22-33.9 inches		23-35.9 inches	

Table 8

Hip Circumference

Inches	Women Pilots AAFFTD		Flying Nurses AAFSAE	
	No. of Cases	%	No. of Cases	%
30-30.9				
31-31.9	1	0.2		
32-32.9			1	0.7
33-33.9	9	2.0	2	1.3
34-34.9	17	3.8	9	5.9
35-35.9	44	9.8	20	13.2
36-36.9	70	15.7	40	26.3
37-37.9	84	18.8	38	25.0
38-38.9	75	16.8	25	16.4
39-39.9	66	14.8	11	7.2
40-40.9	40	9.0	6	3.9
41-41.9	15	3.4		
42-42.9	19	4.2		
43-43.9	2	0.4		
44-44.9	5	1.1		
Total	447		152	
Mean	38.12 inches		37.14 inches	
Range	31-44.9 inches		32-40.9 inches	

Table 9

Shoulder Height

Centimeters	Women Pilots AAFPTD		Flying Nurses AAFSAE	
	No. of Cases	%	No. of Cases	%
50-50.9			1	0.7
51-51.9			1	0.7
52-52.9			1	0.7
53-53.9	1	0.2	7	4.6
54-54.9	1	0.2	4	2.6
55-55.9	7	1.6	9	5.9
56-56.9	15	3.4	14	9.2
57-57.9	32	7.2	25	16.4
58-58.9	58	13.0	17	11.2
59-59.9	80	18.0	28	18.4
60-60.9	77	17.3	13	8.6
61-61.9	71	16.0	13	8.6
62-62.9	45	10.1	12	7.9
63-63.9	35	7.9	5	3.3
64-64.9	12	2.7		
65-65.9	7	1.6	1	0.7
66-66.9	4	0.9	1	0.7
Total	445		152	
Mean	60.43 cm. (23.8 inches)		58.69 cm. (23.1 inches)	
Range	53-66.9 cm. (20.8-26.3 inches)		50-66.9 cm. (19.7-26.3 inches)	

Table 10

Waist Height

Centimeters	Women Pilots AAFFTD		Flying Nurses AAFSAE	
	No. of Cases	%	No. of Cases	%
91-91.9			1	0.7
92-92.9			1	0.7
93-93.9			1	0.7
94-94.9	8	1.8	5	3.3
95-95.9	6	1.3	4	2.6
96-96.9	9	2.0	6	4.0
97-97.9	22	4.9	13	8.6
98-98.9	22	4.9	12	7.9
99-99.9	22	4.9	15	9.9
100-100.9	33	7.4	12	7.9
101-101.9	51	11.4	11	7.2
102-102.9	37	8.3	18	11.8
103-103.9	47	10.5	18	11.8
104-104.9	39	8.7	12	7.9
105-105.9	35	7.8	7	4.6
106-106.9	35	7.8	2	1.3
107-107.9	15	3.4	4	2.6
108-108.9	27	6.0	2	1.3
109-109.9	16	3.6	7	4.6
110-110.9	12	2.7		
111-111.9	3	0.7	1	0.7
112-112.9	3	0.7		
113-113.9	1	0.2		
114-114.9				
115-115.9	2	0.4		
116-116.9	1	0.2		
117-117.9	1	0.2		
Total	447		152	
Mean	102.88 cm. (40.5 inches)		100.90 cm. (39.7 inches)	
	94-117.9 cm. (36.9-46.4 inches)		91-111.9 cm. (35.8-44.1 inches)	

Table 11

Crotch Height

Centimeters	Women Pilots AAFFTD		Flying Nurses AAFSAE	
	No. of Cases	%	No. of Cases	%
66-66.9			1	0.7
67-67.9			1	0.7
68-68.9	1	0.2	3	2.0
69-69.9	1	0.2	4	2.6
70-70.9	6	1.3	8	5.3
71-71.9	19	4.2	12	7.9
72-72.9	23	5.1	15	9.9
73-73.9	24	5.4	15	9.9
74-74.9	43	9.6	17	11.3
75-75.9	43	9.6	20	13.2
76-76.9	50	11.2	24	15.9
77-77.9	64	14.3	10	6.6
78-78.9	41	9.2	4	2.6
79-79.9	34	7.6	4	2.6
80-80.9	36	8.0	4	2.6
81-81.9	20	4.5	4	2.6
82-82.9	20	4.5	4	2.6
83-83.9	10	2.2	1	0.7
84-84.9	7	1.6		
85-85.9	1	0.2		
86-86.9	3	0.7		
87-87.9				
88-88.9	1	0.2		
Total	447		151	
Mean	77.28 cm. (30.5 inches)		74.90 cm. (29.5 inches)	
Range	68.0-88.9 cm. (26.8-35.0 inches)		66.0-83.9 cm. (26.0-33.0 inches)	

Table 12

Arm Length

Centimeters	Women Pilots AAFTD		Flying Nurses AAFSAE	
	No. of Cases	%	No. of Cases	%
64.8-65.5	2	0.4	1	0.7
65.6-66.3	4	0.9	4	2.6
66.4-67.1	4	0.9	3	2.0
67.2-67.9	10	2.2	6	3.9
68.0-68.7	13	2.9	11	7.2
68.8-69.5	34	7.6	9	5.9
69.6-70.3	44	9.9	19	12.5
70.4-71.1	34	7.6	13	8.6
71.2-71.9	43	9.7	15	9.9
72.0-72.7	46	10.3	21	13.8
72.8-73.5	41	9.2	18	11.8
73.6-74.3	46	10.3	7	4.6
74.4-75.1	43	9.7	9	5.9
75.2-75.9	25	5.6	2	1.3
76.0-76.7	20	4.5	7	4.6
76.8-77.5	15	3.4	1	0.7
77.6-78.3	7	1.6	4	2.6
78.4-79.1	6	1.4	4	2.6
79.2-79.9	5	1.1		
80.0-80.7	2	0.4	1	0.7
80.8-81.5	1	0.2	1	0.7
Total	445		152	
Mean	72.66 cm. (28.6 inches)		71.72 cm. (28.2 inches)	
Range	64.8-81.5 cm.		64.8-81.5 cm.	

Table 13

Anterior Arm Reach

Centimeters	Women Pilots AAFISD		Flying Nurses AAFSAE	
	No. of Cases	%	No. of Cases	%
70-71.9			4	2.6
72-73.9	2	.4	5	3.3
74-75.9	28	6.3	16	10.5
76-77.9	70	15.7	39	25.7
78-79.9	81	18.1	30	19.7
80-81.9	121	27.1	26	17.1
82-83.9	71	15.9	20	13.1
84-84.9	45	10.1	9	5.9
86-87.9	22	4.9	2	1.3
88-89.9	7	1.6	1	.7
Total	447		152	
Mean	80.74 cm. (31.8 inches)		79.05 cm. (31.1 inches)	
Range	72-89.9 cm. (28.3-35.4 inches)		70.89.9 cm. (27.5-35.4 inches)	

Table 14

Hand Length

Millimeters	Women Pilots AAFFTD		Flying Nurses AAFSAE	
	No. of Cases	%	No. of Cases	%
145-148	1	.2		
149-152			1	.7
153-156	1	.2		
157-160	11	2.5	1	.7
161-164	28	6.4	8	5.6
165-168	45	10.3	9	6.3
169-172	56	12.8	25	17.6
173-176	98	22.4	35	24.6
177-180	77	17.6	26	18.3
181-184	62	14.2	20	14.1
185-188	31	7.1	13	9.2
189-192	17	3.9	3	2.1
193-196	7	1.6	1	.7
197-200	1	.2		
201-204				
205-208	2	.5		
Total	437		142	
Mean	175.8 mm. (6.92 inches)		175.8 mm. (6.92 inches)	
Range	145-207 mm. (5.7-8.2 inches)		152-194 mm. (6.0-7.6 inches)	

Table 15
Hand Breadth

Millimeters	Women Pilots AAFFTD		Flying Nurses AAFSAE	
	No. of Cases	%	No. of Cases	%
65-66	1	0.2	1	0.7
67-68	1	0.2	1	0.7
69-70	6	1.4	6	4.2
71-72	24	5.4	14	9.9
73-74	67	15.2	19	13.4
75-76	88	20.0	33	23.2
77-78	97	22.0	34	23.9
79-80	91	20.7	18	12.7
81-82	36	8.2	14	9.9
83-84	22	5.0	2	1.4
85-86	6	1.4		
87-88	1	0.2		
Total	440		142	
Mean	77.17 mm. (3.04 inches)		76.19 mm. (3.00 inches)	
Range	66-87 mm. (2.6-3.4 inches)		66-84 mm. (2.6-3.3 inches)	

Table 16

Head Circumference

Millimeters	Women Pilots WAFWTD		Flying Nurses AAFSAF	
	No. of Cases	%	No. of Cases	%
511-515	1	0.2		
516-520	5	1.1	3	2.1
521-525	5	1.1	4	2.8
526-530	15	3.4	5	3.5
531-535	37	8.4	20	14.2
536-539	36	8.2	15	10.6
541-545	58	13.2	18	12.8
546-550	59	13.4	29	20.6
551-555	43	9.8	19	13.5
556-560	59	13.4	10	7.1
561-565	49	11.1	6	4.3
566-570	26	5.9	5	3.5
571-575	15	3.4	1	0.7
576-580	16	3.6	4	2.8
581-585	10	2.3	2	1.4
586-590	2	0.5		
591-595	3	0.7		
596-600	1	0.2		
Total	440		141	
Mean	552.0 mm. (21.73 inches)		545.9 mm. (21.49 inches)	
Range	517-584 mm. (20.4-22.9 inches)		512-597 mm. (20.2-23.5 inches)	

Table 17

Bideloid

Centimeters	Women Pilots AAFSTD		Flying Nurses AAFSAE	
	No. of Cases	%	No. of Cases	%
33-33.9			1	0.7
34-34.9				
35-35.9	1	0.2	1	0.7
36-36.9	9	2.0	7	4.6
37-37.9	17	3.8	8	5.3
38-38.9	58	13.0	31	20.4
39-39.9	69	15.4	40	26.3
40-40.9	89	19.9	28	18.4
41-41.9	76	17.0	22	14.5
42-42.9	59	13.2	11	7.2
43-43.9	34	7.6	3	2.0
44-44.9	21	4.7		
45-45.9	12	2.7		
46-46.9	2	0.5		
Total	447		152	
Mean	40.89 cm. (16.1 inches)		39.76 cm. (15.7 inches)	
Range	35-46.9 cm. (13.8-18.5 inches)		33-43.9 cm. (13.0-17.3 inches)	

Table 19

Elbow Breadth

Centimeters	Women Pilots AAFFTD		Flying Nurses AAFSAE	
	No. of Cases	%	No. of Cases	%
31-31.9	1	0.2		
32-32.9	7	1.6	2	1.3
33-33.9	15	3.4	3	2.0
34-34.9	29	6.5	12	7.9
35-35.9	41	9.2	19	12.5
36-36.9	60	13.5	22	14.5
37-37.9	57	12.8	27	17.8
38-38.9	58	13.0	21	13.8
39-39.9	49	11.0	18	11.8
40-40.9	48	10.8	14	9.2
41-41.9	25	5.6	6	3.9
42-42.9	25	5.6	4	2.6
43-43.9	15	3.4	3	2.0
44-44.9	5	1.1		
45-45.9	5	1.1		
46-46.9	1	0.2		
47-47.9	3	0.7		
48-48.9			1	0.7
49-49.9				
50-50.9				
51-51.9				
52-52.9				
53-53.9	1	0.2		
Total	445		152	
Mean	38.43 cm. (15.1 inches)		37.86 cm. (14.9 inches)	
Range	31-53 cm. (12.2-20.9 inches)		32-48.9 cm. (12.6-19.3 inches)	

Table 19

Bi-iliae

Stature in Centimeters	Women Pilots AAFFTD		Flying Nurses AAFSAE	
	No. of Cases	%	No. of Cases	%
24-24.9	15	3.4	3	2.0
25-25.9	37	8.3	5	3.3
26-26.9	77	17.2	22	14.4
27-27.9	96	21.5	27	17.7
28-28.9	111	24.3	42	27.6
29-29.9	66	14.8	34	22.4
30-30.9	30	6.7	15	9.9
31-31.9	12	2.7	3	2.0
32-32.9	1	.2	1	.7
33-33.9	2	.4		
Total	447		152	
Mean	27.95 cm. (11.0 inches)		28.36 cm. (11.2 inches)	
Range	24-33.9 cm. (9.4-13.3 inches)		24-32.9 cm. (9.4-13.0 inches)	

Table 20

Bitrochanteric

Centimeters	Women Pilots AAFFTD		Flying Nurses AAFSAE	
	No. of Cases	%	No. of Cases	%
30-30.9	1	0.2		
31-31.9	1	0.2		
32-32.9	3	0.7	1	0.7
33-33.9	12	2.7	6	3.9
34-34.9	30	6.7	4	2.6
35-35.9	45	10.1	9	5.9
36-36.9	55	12.3	14	9.2
37-37.9	67	15.0	36	23.7
38-38.9	76	17.0	27	17.8
39-39.9	64	14.3	19	12.5
40-40.9	41	9.2	14	9.2
41-41.9	18	4.0	14	9.2
42-42.9	14	3.1	6	3.9
43-43.9	8	1.8	2	1.3
44-44.9	4	0.9		
45-45.9	4	0.9		
46-46.9	3	0.7		
47-47.9	1	0.2		
Total	447		152	
Mean	38.18 cm. (15.0 inches)		38.37 cm. (15.1 inches)	
Range	30-47.9 cm. (11.8-18.9 inches)		32-43.9 cm. (12.6-17.3 inches)	

Table 21

Span - Akimbo

Centimeters	Women Pilots AAFFTD		Flying Nurses AAFSAE	
	No. of Cases	%	No. of Cases	%
75-75.9			1	0.7
76-76.9				
77-77.9	2	0.4	4	2.7
78-78.9	3	0.7	5	3.3
79-79.9	5	1.1	7	4.7
80-80.9	10	2.2	4	2.7
81-81.9	13	2.9	3	2.0
82-82.9	16	3.5	15	10.0
83-83.9	43	9.6	20	13.3
84-84.9	48	10.8	17	11.3
85-85.9	43	9.6	20	13.3
86-86.9	42	9.4	16	10.7
87-87.9	44	9.9	11	7.3
88-88.9	43	9.6	9	6.0
89-89.9	45	10.1	6	4.0
90-90.9	28	6.3	5	3.3
91-91.9	18	4.0	4	2.7
92-92.9	19	4.3	1	0.7
93-93.9	10	2.2	1	0.7
94-94.9	10	2.2	1	0.7
95-95.9	3	0.7		
96-96.9				
97-97.9	1	0.2		
Total	446		150	
Mean	87.02 cm. (34.3 inches)		84.89 cm. (33.4 inches)	
Range	77-95.9 cm. (30.3-37.8 inches)		75-94.9 cm. (29.5-37.4 inches)	

Table 22
Shoulder-Elbow Height

Centimeters	Women Pilots AAFFTD		Flying Nurses AAFSAE	
	No. of Cases	%	No. of Cases	%
30-30.9	1	0.2	1	0.7
31-31.9	12	2.7	4	2.6
32-32.9	45	10.1	14	9.3
33-33.9	93	20.8	34	22.5
34-34.9	111	24.8	44	29.1
35-35.9	103	23.0	30	19.9
36-36.9	51	11.4	12	7.9
37-37.9	23	5.1	9	6.0
38-38.9	6	1.3	2	1.3
39-39.9	2	0.4	1	0.7
Total	447		151	
Mean	34.69 cm. (13.7 inches)		34.60 cm. (13.6 inches)	
Range	30-39.9 cm. (11.8-15.7 inches)		30-39.9 cm. (11.8-15.7 inches)	

Table 23
Eye Height

Centimeters	Women Pilots AAFFTD		Flying Nurses AAFSAE	
	No. of Cases	%	No. of Cases	%
65-65.9			1	0.7
66-66.9			1	0.7
67-67.9			1	0.7
68-68.9	1	0.2	3	2.0
69-69.9	1	0.2	5	3.3
70-70.9	4	0.9	8	5.3
71-71.9	6	1.4	11	7.3
72-72.9	24	5.4	10	6.6
73-73.9	57	12.9	27	17.9
74-74.9	54	12.2	19	12.6
75-75.9	74	16.7	23	15.2
76-76.9	71	16.0	17	11.3
77-77.9	56	12.6	15	9.9
78-78.9	49	11.1	3	2.0
79-79.9	22	5.0	4	2.6
80-80.9	13	2.9	1	0.7
81-81.9	6	1.4	1	0.7
82-82.9	3	0.7		
83-83.9	1	0.2	1	0.7
84-84.9	1	0.2		
Total	443		151	
Mean	76.09 cm. (30.0 inches)		74.35 cm. (29.3 inches)	
Range	68-84.9 cm. (26.8-33.4 inches)		65-83.9 cm. (25.6-33.0 inches)	

Table 24

Sitting Height

Centimeters	Women Pilots AAFPTD		Flying Nurses AAFSAE	
	No. of Cases	%	No. of Cases	%
77-77.9			1	0.7
78-78.9	1	0.2	1	0.7
79-79.9			3	2.0
80-80.9	5	1.1	3	2.0
81-81.9	9	2.0	10	6.6
82-82.9	28	6.3	12	7.9
83-83.9	35	7.8	20	13.2
84-84.9	52	11.7	11	9.2
85-85.9	55	12.3	18	11.8
86-86.9	72	16.1	24	15.8
87-87.9	68	15.2	13	8.6
88-88.9	54	12.1	12	7.9
89-89.9	28	6.3	9	5.9
90-90.9	18	4.0	8	5.3
91-91.9	15	3.4	2	1.3
92-92.9	3	0.7	1	0.7
93-93.9	2	0.4		
94-94.9	1	0.2	1	0.7
Total	446		152	
Mean	86.56 cm. (34.1 inches)		85.58 cm. (33.7 inches)	
Range	78-94.9 cm. (30.7-37.4 inches)		77-94.9 cm. (30.3-37.4 inches)	

Table 25

Buttock-Knee Length

Centimeters	Women Pilots AAFSTD		Flying Nurses AAFSAE	
	No. of Cases	%	No. of Cases	%
50-50.9	2	0.4	1	0.7
51-51.9	3	0.7	4	2.6
52-52.9	4	0.9	1	0.7
53-53.9	22	4.9	10	6.8
54-54.9	43	9.6	17	11.2
55-55.9	48	10.7	20	13.2
56-56.9	69	15.4	31	20.4
57-57.9	62	13.9	24	15.8
58-58.9	73	16.3	19	12.5
59-59.9	56	12.5	11	7.2
60-60.9	33	7.4	7	4.6
61-61.9	19	4.2	5	3.3
62-62.9	8	1.8	1	0.7
63-63.9	2	0.4	1	0.7
64-64.9	2	0.4		
65-65.9				
66-66.9				
67-67.9	1	0.2		
Total	447		152	
Mean	57.50 cm. (22.6 inches)		56.81 cm. (22.4 inches)	
Range	50-67.9 cm. (19.7-26.7 inches)		50-63.9 cm. (19.7-25.2 inches)	

Table 26

Patella Height

Centimeters	Women Pilots AAFSTD		Flying Nurses AAPSAC	
	No. of Cases	%	No. of Cases	%
44-44.9			2	1.3
45-45.9	1	0.2	5	3.3
46-46.9	7	1.6	12	7.9
47-47.9	25	5.6	17	11.2
48-48.9	42	9.4	27	17.
49-49.9	77	17.3	31	20.4
50-50.9	72	16.2	27	17.8
51-51.9	86	19.3	12	7.9
52-52.9	68	15.3	12	7.9
53-53.9	34	7.6	4	2.6
54-54.9	22	4.9	3	2.0
55-55.9	6	1.3		
56-56.9	4	0.9		
57-57.9				
58-58.9	1	0.2		
Total	445		152	
Mean	50.96 cm. (20.1 inches)		49.44 cm. (19.5 inches)	
Range	45-58.9 cm. (17.7-23.2 inches)		44-54.9 cm. (17.3-21.6 inches)	

Table 27

Knee Breadth

Centimeters	Women Pilots AAFFTD		Flying Nurses AAFSAE	
	No. of Cases	%	No. of Cases	%
13.5-13.9	1	0.2		
14.0-14.4				
14.5-14.9				
15.0-15.4				
15.5-15.9	1	0.2		
16.0-16.4	1	0.2	1	0.7
16.5-16.9	13	2.9	3	2.0
17.0-17.4	25	5.6	8	5.3
17.5-17.9	47	10.6	16	10.5
18.0-18.4	53	11.9	21	13.8
18.5-18.9	75	16.9	29	19.1
19.0-19.4	70	15.8	22	14.5
19.5-19.9	45	10.1	14	9.2
20.0-20.4	37	8.3	11	7.2
20.5-20.9	25	5.6	16	10.5
21.0-21.4	22	5.0	5	3.3
21.5-21.9	9	2.0	2	1.3
22.0-22.4	6	1.4	1	0.7
22.5-22.9	5	1.1		
23.0-23.4	3	0.7		
23.5-23.9	1	0.2	1	0.7
24.0-24.4	1	0.2	2	1.3
24.5-24.9	2	0.5		
25.0-25.4				
25.5-25.9	2	0.5		
Total	444		152	
Mean	19.18 cm. (7.55 inches)		19.12 cm. (7.53 inches)	
Range	13.5-25.9 cm. (5.3-10.2 inches)		16.0-24.4 cm. (6.3-9.6 inches)	

Table 28
Forearm Circumference

Inches	Women Pilots AAFFTD		Flying Nurses AAFSAE	
	No. of Cases	%	No. of Cases	%
6.3-6.4	6	1.3	1	0.7
6.5-6.6	13	2.9	4	2.7
6.7-6.8	20	4.5	6	4.0
6.9-7.0	61	13.7	19	12.8
7.1-7.2	60	13.5	22	14.8
7.3-7.4	56	12.6	15	10.1
7.5-7.6	58	13.0	15	10.1
7.7-7.8	49	11.0	14	9.4
7.9-8.0	67	15.1	28	18.8
8.1-8.2	28	6.3	12	8.0
8.3-8.4	10	2.2	3	2.0
8.5-8.6	10	2.2	7	4.7
8.7-8.8	4	0.9	1	0.7
8.9-9.0	1	0.2	2	1.3
9.1-9.2	1	0.2		
9.3-9.4				
9.5-9.6	1	0.2		
Total	445		149	
Mean	7.49 inches		7.56 inches	
Range	6.3-9.6 inches		6.3-9.0 inches	

Table 29

Upper Arm Circumference

Inches	Women Pilots AAFFTD		Flying Nurses AAFSAE	
	No. of Cases	%	No. of Cases	%
7.5			1	0.7
7.9-8.0	2	0.5		
8.1-8.2	4	0.9	1	0.7
8.3-8.4	6	1.4	3	2.0
8.5-8.6	6	1.4	2	1.3
8.7-8.8	24	5.4	10	6.7
8.9-9.0	39	8.8	15	10.1
9.1-9.2	36	8.1	16	10.7
9.3-9.4	36	8.1	14	9.4
9.5-9.6	40	9.0	21	14.1
9.7-9.8	57	12.8	17	11.4
9.9-10.0	41	9.2	15	10.0
10.1-10.2	38	8.6	8	5.4
10.3-10.4	21	4.7	9	6.0
10.5-10.6	23	5.2	5	3.4
10.7-10.8	20	4.5	3	2.0
10.9-11.0	23	5.2	7	4.7
11.1-11.2	8	1.8	2	1.3
11.3-11.4	5	1.1		
11.5-11.6	7	1.6		
11.7-11.8	2	0.5		
11.9-12.0	2	0.5		
12.1-12.2	2	0.5		
12.3-12.4	1	0.2		
12.5-12.6	1	0.2		
Total	444		149	
Mean	9.81 inches		9.60 inches	
Range	7.9-12.6 inches		7.5-11.2 inches	

Table 30

Calf Circumference

Inches	Women Pilots AAFSTD		Flying Nurses AAFSAE	
	No. of Cases	%	No. of Cases	%
10.5-10.9			1	0.7
11.0-11.4	1	0.2		
11.5-11.9	5	1.1	1	0.7
12.0-12.4	20	4.5	9	6.0
12.5-12.9	46	10.4	20	13.4
13.0-13.4	90	20.3	39	26.2
13.5-13.9	99	22.3	31	20.8
14.0-14.4	89	20.0	31	20.8
14.5-14.9	48	10.8	11	7.4
15.0-15.4	33	7.4	5	3.4
15.5-15.9	9	2.0	1	0.7
16.0-16.4	4	0.9		
Total	444		149	
Mean	13.78 inches		13.55 inches	
Range	11.0-16.4 inches		10.5-15.9 inches	

Table 31

Thigh Circumference

Inches	Women Pilots AAFSTD		Flying Nurses AAFSAE	
	No. of Cases	%	No. of Cases	%
15.5-15.9	1	0.2		
16.0-16.4	1	0.2		
16.5-16.9	5	1.1	1	0.7
17.0-17.4	13	2.9	5	3.3
17.5-17.9	37	8.3	14	9.2
18.0-18.4	55	12.3	15	9.9
18.5-18.9	60	13.5	21	13.8
19.0-19.4	67	15.0	21	13.8
19.5-19.9	52	11.7	21	13.8
20.0-20.4	55	12.3	25	16.5
20.5-20.9	40	9.0	10	6.6
21.0-21.4	31	7.0	9	5.9
21.5-21.9	7	1.6	6	3.9
22.0-22.4	10	2.2	4	2.6
22.5-22.9	6	1.3		
23.0-23.4	3	0.7		
23.5-23.9	1	0.2		
24.0-24.4	1	0.2		
24.5-24.9	1	0.2		
Total	446		152	
Mean	19.45 inches		19.44 inches	
Range	15.5-24.9 inches		16.5-22.4 inches	

5. References

Chapter II - The Functional Man.

- EXP-M-49-695-15 Facial Types Among Aviation Cadets.
9 September 1942
- EXP-M-49-695-19A Coordination of Winter Helmets with Head Size and
21 December 1942 Flying Equipment.

Chapter III - Personal Equipment.

- EXP-M-49-695-4 Anthropometric Facial Survey at Wilberforce
7 July 1942 University.
- EXP-M-49-695-4A Anthropological Survey of AAF Cadets.
5 August 1942
- EXP-M-49-695-15 Facial Types Among Aviation Cadets.
9 September 1942
- EXP-M-49-695-19A Coordination of Winter Helmets with Head Size and
21 December 1942 Flying Equipment.
- ENG-M-49-695-22A Demand Oxygen Mask.
12 February 1943
- ENG-49-695-32 Effect of Flying Clothing on Body Measurements of
18 August 1943 AAF Flyers.
- ENG-49-695-32A Body Measurements of Female Flying Personnel.
1 September 1943
- ENG-49-695-32B Body Sizes of Pursuit Pilots.
20 September 1943
- ENG-49-695-32C Head, Face and Hand Measurements of Flying Nurses
20 October 1943 and Female Pilots.
- ENG-49-695-32D Sizing of AAF Clothing (Jackets and Trousers).
23 October 1943
- ENG-49-695-32E Hand Size and Required Glove Size for Flying
5 November 1943 Personnel.
- ENG-49-695-32F Steel Helmets for Aircrew.
12 November 1943
- ENG-49-695-32G Size Tests of A-11 Helmets.
12 November 1943

ENG-49-659-32H 12 November 1943	Head and Face Measurements of Fighter Pilots and Heavy Bombardment Crews.
ENG-49-695-32J 22 November 1943	Switlik 24-Foot Seat-Type Parachute - Suitability for Wear in Turrets.
ENG-49-695-32J 1 December 1943	Size Test of Model Helmets (Spec No. AN-H-15).
ENG-49-695-32K 11 December 1943	Size Test of Model Helmets (Spec No. AN-H-15).
ENG-49-695-32M 17 February 1944	Sizing of Army-Navy Shearling.
ENG-49-695-32N 4 March 1944	Women's Flying Clothing.
ENG-49-695-2G 28 January 1944	Hand Wear.
ENG-49-695-22R 26 February 1944	Mask, Oxygen, Pressure-Demand.
ENG-49-695-32R 7 May 1944	Head Size Standards.
ENG-49-695-32S 31 May 1944	Size Testing of Gloves.
ENG-49-695-32T 31 May 1944	Size of Clothing for Female Flying Personnel.
ENG-49-695-32V 20 June 1944	Tailor's Dimensions of AAF Flying Personnel.
ENG-49-695-32W 7 July 1944	Sizing of Intermediate Suits.
ENG-49-695-32Y 8 August 1944	Shoe Size Among Flying Personnel.
ENG-49-695-32Z 11 August 1944	Size Scheduling of the F-3 Electrically Heated Suit.
ENG-49-695-32AA 16 August 1944	Memorandum Report on "Flak Suit Extensions Preliminary Combat Test."

TSEAL-3-695-32JJ 21 December 1944	Comparison of Variability in Flying Clothing.
TSEAL-3-695-32MM 12 January 1945	Master Charts for Distribution of Clothing Sizes for Female Personnel.
TSEAL-3-695-32VV 15 May 1945	Glove Size Gauge.
TSEAL-3-695-32XX 28 May 1945	Tailor's Dimensions and Head and Face Measurements of V. H. B. Personnel.
TSEAL-3-695-32GGG 4 August 1945	Comparison of Variability in Flying Clothing.
TSEAL-3-695-32HHH 8 August 1945	Comparison of Variability in Flying Clothing.

Chapter IV - Aircrew Positioning.

EXP-M-695-4A 5 August 1942	Anthropological Survey of AAF Cadets.
EXP-M-49-695-4D 14 October 1942	Anthropological Analysis of Martin Upper Local Turret.
EXP-M-49-695-4F 14 November 1942	Anthropological Analysis of the Consolidated Tail Turret.
EXP-M-49-695-4G 16 November 1942	Anthropological Analysis of the Emerson Tail Turret.
EXP-M-49-695-4H 18 November 1942	Anthropological Analysis of the Emerson 64" Pressurized Ball Turret.
EXP-M-49-695-4I 14 December 1942	Anthropological Analysis of the Motor Products Tail Turret.
EXP-M-49-695-4J 28 December 1942	Upper Local Control Turrets - Visibility.
EXP-M-49-695-4K 7 January 1943	Anthropological Analysis of the Briggs 46" Ball Turret.
EXP-M-49-695-4M 19 January 1943	Consolidated Tail Turret - Scanning Visibility.
EXP-M-49-695-4N 13 February 1943	44 Inch Ball Turret - Scanning Visibility.

EXP-M-49-695-4Q 13 February 1943	Gunner's Comfort, Efficiency and Safety in the Sperry Upper Turret.
EXP-M-49-695-4R 15 March 1943	Gunner's Comfort, Efficiency and Safety in the Bendix Upper Turret.
ENG-49-695-28 5 June 1943	Articulated Plastic Manikin Standards.
ENG-49-695-32 18 August 1943	Effect of Flying Clothing on Body Measurements of AAF Flyers.
ENG-49-695-32B 20 September 1943	Body Sizes of Pursuit Pilots.
ENG-49-695-32F 12 November 1943	Steel Helmets for Aircrew.
ENG-49-695-32P 25 February 1944	Prone Position.
ENG-49-695-38 4 November 1944	Pilot's Head Support.
ENG-49-695-40 1 December 1943	Pilot's Hold-Down Harness.
TR # 4990 17 August 1943	Eye Movement in Sighting.
ENG-49-695-32Q 17 April 1944	Forty-eight Inch Upper Ball Turret.
ENG-49-695-32U 6 June 1944	Emerson Electric Company Turret Inspection Visit.
TSEAL-3-695-32HH 4 December 1944	The Center of Gravity of the Seated Fighter Pilot.
TSEAL-3-695-32LL 5 January 1945	Gunners' Provisions in Proposed Martin "Streamlined" Turrets for the B-32.
TSEAL-3-695-32RR 11 March 1945	Universal Test Seat and Cockpit Mock-up.
TSEAL-3-695-32TT 29 April 1945	Cockpit Dimensions in Relation to Human Body Size.
TSEAL-3-695-32YY 30 May 1945	Navy Experimental Molded Combination Seat and Back Cushion.

TSEAL-3-695-32AAA
30 June 1945

B-29 Side Sighting Station-Travel Report.

TSEAL-3-695-32CCC
12 July 1945

Pulsating Parachute Seat Cushion Report No. 1.

TSEAL-3-695-32DDD
14 July 1945

Head Movement in Standard AAF Turrets.

TSEAL-3-695-32EEE
20 July 1945

Comfort Evaluation of the Hammock Type Fighter Seat.

TSEAL-3-695-58
25 September 1945

Principles of Seating in Fighter Type Aircraft.

TSEAL-3-695-58A
6 September 1945

Body Size Requirements in Bombardier-Navigator Seating.

TSEAL-3-695-58B
30 October 1945

Pulsating Parachute Seat Cushion Report No. 2.

Chapter V - Aircraft Clearances.

TSEAL-3-695-32II
27 January 1945

Physical Requirements for Size and Shape of Escape Hatches, Bombardment and Attack.

TSEAL-3-695-32SS
30 April 1945

Optimum Shape and Minimum Size of Catwalks in Bombardment Aircraft.

Chapter VII - Head and Eye Movement in Sighting.

TR # 4990
17 August 1943

Eye Movement in Sighting.

TR # 4887
4 February 1943

The Design of Turret Sighting Panels.

CHAPTER IX

List of Photographs

	Page
Chapter II - The Functional Man.	
Figure II, 1 - Variation of body size in male flying personnel.....	7
Figure II, 2 - Bulk added to nude man by standard flying clothing.....	8
Chapter III - Personal Equipment.	
Figure III, 1 - Standard head personal equipment.....	14
Figure III, 2 - Standard pressure-demand oxygen personal equipment.....	15
Figure III, 3 - Distribution chart of head circumferences.....	17
Figure III, 4 - Inspection measurements for helmet inspection.....	18
Figure III, 5 - Desired dimensions for AN-H-16 helmet.....	19
Figure III, 6 - Desired dimensions for A-11 helmet.....	20
Figure III, 7 - Desired dimensions for AN-H-15 helmet.....	21
Figure III, 8 - Dimensions of AML head size standards.....	22
Figure III, 9 - Small size AML head size standard.....	23
Figure III, 10 - AML head size standards.....	24
Figure III, 11 - AAF face size standards.....	28
Figure III, 12 - Distribution of AAF face sizes.....	29
Figure III, 13 - Frequency distribution chart of AAF male face sizes...	31
Figure III, 14 - Percentage distribution stature and chest total bombardment.....	37
Figure III, 15 - Percentage distribution stature and chest total issue.....	38
Figure III, 16 - Percentage distribution stature and chest very heavy bombardment.....	39
Figure III, 17 - Percentage distribution stature and torso total bombardment.....	40

	Page
Figure III, 18 - Percentage distribution stature and torso total issue.....	41
Figure III, 19 - Percentage distribution chest and sleeve heavy bombardment.....	42
Figure III, 20 - Percentage distribution chest and sleeve total issue.....	43
Figure III, 21 - Percentage distribution chest and sleeve very heavy bombardment.....	44
Figure III, 22 - Percentage distribution waist and inseam heavy bombardment.....	45
Figure III, 23 - Percentage distribution waist and inseam total issue.....	46
Figure III, 24 - Percentage distribution waist and inseam very heavy bombardment.....	47
Figure III, 25 - Glove size gauge.....	49
Figure III, 26 - Glove size gauge, method of use.....	50
Figure III, 27 - Correlation chart, hand breadth and circumference....	51
Figure III, 28 - Percentage distribution shoe size fighter pilots.....	55
Figure III, 29 - Percentage distribution shoe size heavy bombardment.....	56
Figure III, 30 - Percentage distribution shoe size total issue.....	57,
Figure III, 31 - Percentage distribution shoe size very heavy bombardment.....	58
Figure III, 32 - Percentage distribution chest and arm length WASP.....	67
Figure III, 33 - Percentage distribution chest and arm length Flying Nurses.....	68
Figure III, 34 - Percentage distribution waist height and waist WASP.....	69
Figure III, 35 - Percentage distribution waist height and waist Flying Nurses.....	70

	Page
Figure III, 36 - Percentage distribution hip circumference and waist height. WASP.....	71
Figure III, 37 - Percentage distribution hip circumference and waist height. Flying Nurses.....	72
Figure III, 38 - Percentage distribution stature and waist total male issue.....	77
 Chapter IV - Aircrew Positioning.	
Figure IV, 1 - Universal Test seat.....	80
Figure IV, 2 - German Air Force cockpit dimensions.....	86
Figure IV, 3 - German Air Force standard cockpit.....	87
Figure IV, 4 - AML 35 inch cockpit.....	88
Figure IV, 5 - Seat contour, 35 inch cockpit.....	89
Figure IV, 6 - AML 37 inch cockpit.....	92
Figure IV, 7 - Seat contour, 37 inch cockpit.....	93
Figure IV, 8 - AML 39 inch cockpit.....	94
Figure IV, 9 - Seat contour, 39 inch cockpit.....	95
Figure IV, 10 - AML 41 inch cockpit.....	96
Figure IV, 11 - Seat contour, 41 inch cockpit.....	97
Figure IV, 12 - AML 43 inch cockpit.....	99
Figure IV, 13 - Seat contour, 43 inch cockpit.....	100
Figure IV, 14 - AML Wheel-type 37 inch cockpit.....	104
Figure IV, 15 - Seat contour, Wheel-type 37 inch cockpit.....	105
Figure IV, 16 - AML Wheel-type 39 inch cockpit.....	106
Figure IV, 17 Seat contour, Wheel-type 39 inch cockpit.....	107
Figure IV, 18 - AML Wheel-type 41 inch cockpit.....	108

	Page
Figure IV, 19 - Seat contour Wheel-type 41 inch cockpit.....	109
Figure IV, 20 - AML Wheel-type 43 inch cockpit.....	110
Figure IV, 21 - Seat contour Wheel-type 43 inch cockpit.....	111
Figure IV, 22 - AML Wheel type 45 inch cockpit.....	112
Figure IV, 23 - Seat contour Wheel-type 45 inch cockpit.....	113
Figure IV, 24 - AML cockpits, dimensional requirements.....	115
Figure IV, 25 - Dimensions, mock-up for center of gravity.....	117
Figure IV, 26 - Method for determining center of gravity.....	118
Figure IV, 27 - Frontal body areas for different ejection angles.....	121
Figure IV, 28 - Body size requirements for ejection seats.....	122
Figure IV, 29 - Body position for ejection at 103°.....	123
Figure IV, 30 - Frontal view of body for ejection at 103°.....	124
Figure IV, 31 - Body position for ejection at 100°.....	125
Figure IV, 32 - Frontal view of body for ejection at 100°	126
Figure IV, 33 - Body position for ejection at 110°.....	127
Figure IV, 34 - Frontal view of body for ejection at 110°.....	128
Figure IV, 35 - Body position for ejection at 120°.....	129
Figure IV, 36 - Frontal view of body for ejection at 120°.....	130
Figure IV, 37 - Schematic drawing of prone position.....	132
Figure IV, 38 - Visibility areas for various prone positions.....	133
Figure IV, 39 - Normal foot motion in prone position.....	134
Figure IV, 40 - Waist windows, B-17.....	138
Figure IV, 41 - Staggered waist windows, B-17.....	139
Figure IV, 42 - Staggered gun mounts, B-24.....	140
Figure IV, 43 - Turret gunner with heavy winter clothing.....	145
Figure IV, 44 - F-1 electrically heated suit.....	146

	Page
Figure IV, 45 - F-2 electrically heated suit.....	147
Figure IV, 46 - Dimensions added by clothing to the nude man.....	148
Figure IV, 47 - Dimensions of turret test subjects.....	149
Figure IV, 48 - Bendix upper turret.....	151
Figure IV, 49 - Consolidated tail turret.....	153
Figure IV, 50 - Range pedal, ball turret.....	155
Figure IV, 51 - Range pedal, ball turret, external view.....	156
Figure IV, 52 - Charging handle, Sperry upper turret.....	157
Figure IV, 53 - Head cramping, Sperry upper turret.....	159
Figure IV, 54 - Perspective view, Consolidated tail turret.....	161
Figure IV, 55 - Visual field, Consolidated tail turret.....	162
Figure IV, 56 - Emerson tail turret, external view.....	164
Figure IV, 57 - Emerson tail turret, internal view.....	165
Figure IV, 58 - Bendix lower turret.....	181
Figure IV, 59 - Top sighting station, B-29.....	182
Figure IV, 60 - Side sighting station, B-29.....	184
Figure IV, 61 - Rear pressure bulkhead, B-29.....	185
Figure IV, 62 - Method for removing injured tail gunner, B-29.....	186
Figure IV, 63 - 1/30th Scale AAF manikins.....	194
Figure IV, 64 - Manikin dimensions.....	195
Figure IV, 65 - Full scale AAF plastic manikins.....	196
Figure IV, 66 - Three views, full scale AAF manikin.....	197
Figure IV, 67 - Full scale plastic manikin seated.....	198
Figure IV, 68 - Female manikin dimensions.....	199
Figure IV, 69 - Full scale AAF female manikins.....	200

	Page
Chapter V - Aircraft Clearances.	
Figure V, 1 - Minimum dimensions of escape hatches.....	204
Figure V, 2 - Mock-up for determining catwalk dimensions.....	207
Chapter VII - Head and Eye Movement in Sighting.	
Figure VII, 1 - Arc of head and eye movement.....	212
Figure VII, 2 - Schematic drawing of optional eye positions.....	213
Figure VII, 3 - Mechanism for planning gun-sights with eye movement..	215
Figure VII, 4 - Method for design of elliptical sighting panel.....	217
Chapter VIII - Appendices.	
Figure VIII, 1, 1 - Anthropometric instruments.....	222
Figure VIII, 2, 1 - Dimensions of the face, frontal view.....	228
Figure VIII, 2, 2 - Dimensions of the face, lateral view.....	229
Figure VIII, 2, 3 - Data sheet for face measurements.....	230
Figure VIII, 3, 1 - Data sheet for body measurements.....	237
Figure VIII, 3, 2 - Body measurement locations.....	238
Figure VIII, 3, 3 - Body measurement locations.....	239
Figure VIII, 3, 4 - Body measurement locations.....	240
Figure VIII, 3, 5 - Body measurement locations.....	241

+

UNCLASSIFIED (CORR. COPY 1)

ATI 25 419 *

(COPIES OBTAINABLE FROM CADO)

ENGINEERING DIVISION, AIR MATERIEL COMMAND (TSEAA)

HUMAN BODY SIZE IN MILITARY AIRCRAFT AND PERSONAL EQUIPMENT

FRANCIS E. RANDALL; A. DAMON; R.S. BENTON AND OTHERS
JUNE '46 335PP PHOTOS, TABLES, DIAGR, DRWGS

AIR MATERIEL COMMAND, WRIGHT-PATTERSON AIR FORCE BASE,
DAYTON, O. (AFTR-5501)

ARTS AND SCIENCES,
MISC. (65)
ANTHROPOLOGY(2)

ANTHROPOMETRY
COCKPITS
CLOTHING, FLYING
PERSONNEL, FLYING -
PSYCHOPHYSIOLOGY

NICAL

UNCLASSIFIED

*WTS, Auth: O&M Lt.,
6 Jul 71*

AD-B807 323